

RADIO TEST REPORT –484387-1TRFWL

Type of assessment:

Final product testing

Type of radio equipment:

Bluetooth Device

Equipment class:

DTS

Applicant:

ORBCOMM License Corp.

Product description:

Shipping Container Tracker

Model (HVIN):

CT1000

Product marketing name:

CT1000

FCC identifier:

FCC ID: XGS-BTCT1

ISED certification number:

IC: 11881A-BTCT1

Contains FCC identifier:

FCC ID: XMR201906EG21G

Contains ISED certification number:

IC: 10224A-201906EG21G

Specifications:

- ◆ FCC 47 CFR Part 15 Subpart C, §15.247
- ◆ RSS-247, Issue 2, Feb 2017, Section 5

Date of issue: January 6, 2023

Moustapha Salah Toubeh, EMC/RF Specialist

Tested by



Signature

David Duchesne, EMC/RF Lab Manager

Reviewed by



Signature

Nemko Canada Inc., a testing laboratory, is accredited by the Standards Council of Canada.
The tests included in this report are within the scope of this accreditation.
The SCC Accreditation Symbol is an official symbol of the Standards Council of Canada, used under licence.

SCC File Number: 15064 (Ottawa/Almonte); 151100 (Montreal); 151097 (Cambridge)

FCC 15.247 and RSS-247; Date: February 2021

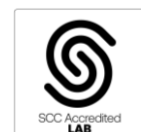



Lab locations

| | | | | |
|--------------|---|---|--|--|
| Company name | Nemko Canada Inc. | | | |
| Facilities | <input checked="" type="checkbox"/> <i>Ottawa site:</i> 303 River Road Ottawa, Ontario Canada K1V 1H2 Tel: +1 613 737 9680 Fax: +1 613 737 9691 | <input type="checkbox"/> <i>Montréal site:</i> 292 Labrosse Avenue Pointe-Claire, Québec Canada H9R 5L8 Tel: +1 514 694 2684 Fax: +1 514 694 3528 | <input type="checkbox"/> <i>Cambridge site:</i> 1-130 Saltsman Drive Cambridge, Ontario Canada N3E 0B2 Tel: +1 519 650 4811 | <input type="checkbox"/> <i>Almonte site:</i> 1500 Peter Robinson Road West Carleton, Ontario Canada K0A 1L0 Tel: +1 613 256-9117 |
| | Organization | Ottawa/Almonte | Montreal | Cambridge |
| | FCC: | CA2040 | CA2041 | CA0101 |
| ISED: | 2040A-4 | 2040G-5 | 24676 | |
| Website | www.nemko.com | | | |

Limits of responsibility

Note that the results contained in this report relate only to the items tested and were obtained in the period between the date of initial receipt of samples and the date of issue of the report.

This test report has been completed in accordance with the requirements of ISO/IEC 17025. All results contained in this report are within Nemko Canada's ISO/IEC 17025 accreditation.

Copyright notification

Nemko Canada Inc. authorizes the applicant to reproduce this report provided it is reproduced in its entirety and for use by the company's employees only. Any use which a third party makes of this report, or any reliance on or decisions to be made based on it, are the responsibility of such third parties.

Nemko Canada Inc. accepts no responsibility for damages, if any, suffered by any third party as a result of decisions made or actions based on this report.

© Nemko Canada Inc.

Table of Contents

| | |
|---|-----------|
| Table of Contents | 3 |
| Section 1 Report summary | 4 |
| 1.1 Test specifications | 4 |
| 1.2 Test methods | 4 |
| 1.3 Exclusions | 4 |
| 1.4 Statement of compliance..... | 4 |
| 1.5 Test report revision history..... | 4 |
| Section 2 Engineering considerations | 5 |
| 2.1 Modifications incorporated in the EUT for compliance | 5 |
| 2.2 Technical judgment | 5 |
| 2.3 Model variants..... | 5 |
| 2.4 Deviations from laboratory tests procedures | 5 |
| Section 3 Test conditions | 6 |
| 3.1 Atmospheric conditions..... | 6 |
| 3.2 Power supply range | 6 |
| Section 4 Measurement uncertainty | 7 |
| 4.1 Uncertainty of measurement | 7 |
| Section 5 Information provided by the applicant..... | 8 |
| 5.1 Disclaimer | 8 |
| 5.2 Applicant/Manufacturer | 8 |
| 5.3 EUT information | 8 |
| 5.4 Radio technical information..... | 8 |
| 5.5 EUT setup details | 9 |
| Section 6 Summary of test results | 10 |
| 6.1 Testing location | 10 |
| 6.2 Testing period..... | 10 |
| 6.3 Sample information | 10 |
| 6.4 FCC test results | 10 |
| 6.5 ISED test results | 11 |
| Section 7 Test equipment..... | 12 |
| 7.1 Test equipment list | 12 |
| Section 8 Testing data..... | 13 |
| 8.1 Variation of power source | 13 |
| 8.2 Number of frequencies | 14 |
| 8.3 Antenna requirement | 16 |
| 8.4 Minimum 6 dB bandwidth for DTS systems | 17 |
| 8.5 Transmitter output power and e.i.r.p. requirements for DTS in 2.4 GHz | 21 |
| 8.6 Spurious (out-of-band) unwanted emissions..... | 24 |
| 8.7 Power spectral density for digitally modulated devices | 31 |

Section 1 Report summary

1.1 Test specifications

| | |
|--|--|
| FCC 47 CFR Part 15, Subpart C, Clause 15.247 | Operation in the 902–928 MHz, 2400–2483.5 MHz, and 5725–585 MHz |
| RSS-247, Issue 2, Feb 2017, Section 5 | Digital Transmission Systems (DTSs), Frequency Hopping Systems (FHSs) and Licence-Exempt Local Area Network (LE-LAN) Devices |

1.2 Test methods

| | |
|--|---|
| 558074 D01 15.247 Meas Guidance v05r02 (April 2, 2019) | Guidance for compliance measurements on digital transmission system, frequency hopping spread spectrum system, and hybrid system devices operating under section 15.247 of the FCC rules. |
| RSS-Gen, Issue 5, April 2018 | General Requirements for Compliance of Radio Apparatus |
| ANSI C63.10 v2013 | American National Standard of Procedures for Compliance Testing of Unlicensed Wireless Devices |

1.3 Exclusions

As a part of co-location testing, simultaneous operation of Cellular transmitter (operating within 2300–2690 MHz) and BLE transmitter was verified. No additional spurious emissions caused by the co-location were detected.

1.4 Statement of compliance

In the configuration tested, the EUT was found compliant.

Testing was performed against all relevant requirements of the test standard except as noted in section 1.3 above. Results obtained indicate that the product under test complies in full with the requirements tested. The test results relate only to the items tested.

Determining compliance is based on the results of the compliance measurement, not taking into account measurement uncertainty, in accordance with section 1.3 of ANSI C63.10 v2013.

See “Summary of test results” for full details.

1.5 Test report revision history

Table 1.5-1: Test report revision history

| Revision # | Date of issue | Details of changes made to test report |
|------------|-----------------|--|
| TRF | January 6, 2023 | Original report issued |

Section 2 Engineering considerations

2.1 Modifications incorporated in the EUT for compliance

There were no modifications performed to the EUT during this assessment.

2.2 Technical judgment

None

2.3 Model variants

There were no model variants declared by the applicant.

2.4 Deviations from laboratory tests procedures

No deviations were made from laboratory procedures.

Section 3 Test conditions

3.1 Atmospheric conditions

| | |
|-------------------|---|
| Temperature | 15 °C – 35 °C |
| Relative humidity | 20 % – 75 % |
| Air pressure | 86 kPa (860 mbar) – 106 kPa (1060 mbar) |

When it is impracticable to carry out tests under these conditions, a note to this effect stating the ambient temperature and relative humidity during the tests shall be recorded and stated.

3.2 Power supply range

The normal test voltage for equipment to be connected to the mains shall be the nominal mains voltage. For the purpose of the present document, the nominal voltage shall be the declared voltage, or any of the declared voltages $\pm 5\%$, for which the equipment was designed.

Section 4 Measurement uncertainty

4.1 Uncertainty of measurement

UKAS Lab 34 and TIA-603-B have been used as guidance for measurement uncertainty reasonable estimations with regards to previous experience and validation of data. Nemko Canada, Inc. follows these test methods in order to satisfy ISO/IEC 17025 requirements for estimation of uncertainty of measurement for wireless products.

Measurement uncertainty budgets for the tests are detailed below. Measurement uncertainty calculations assume a coverage factor of $K = 2$ with 95% certainty.

Table 4.1-1: Measurement uncertainty calculations

| Test name | Measurement uncertainty, \pm dB |
|-----------------------------------|-----------------------------------|
| All antenna port measurements | 0.55 |
| Occupied bandwidth | 4.45 |
| Conducted spurious emissions | 1.13 |
| Radiated spurious emissions | 3.78 |
| AC power line conducted emissions | 3.55 |

Section 5 Information provided by the applicant

5.1 Disclaimer

This section contains information provided by the applicant and has been utilized to support the test plan. Inaccurate information provided by the applicant can affect the validity of the results contained within this test report. Nemko accepts no responsibility for the information contained within this section and the impact it may have on the test plan and resulting measurements.

5.2 Applicant/Manufacturer

| | |
|----------------------|--|
| Name | ORBCOMM License Corp. |
| Address | 395 W Passaic Street, Suite 325, Rochelle Park, NJ 07662 USA |
| Manufacturer name | Same as applicant |
| Manufacturer address | Same as applicant |

5.3 EUT information

| | |
|---------------------------------|---|
| Product name | CT1000 |
| Model number (HVIN) | CT1000 |
| Product description | Shipping Container Tracker |
| Serial number | JJKA4223600066 JJKA4223600069 |
| Part number | CT1000-0100-H |
| Power requirements | Battery powered device: 3.7 VDC |
| Description/theory of operation | CT1000 is a mobile M2M device which supports both LTE/WCDMA/GSM and Bluetooth Lower Energy. |

5.4 Radio technical information

| | |
|--|---|
| Category of Wideband Data Transmission equipment | <input type="checkbox"/> Frequency Hopping Spread Spectrum (FHSS) equipment <input checked="" type="checkbox"/> Other types of Wideband Data Transmission equipment (e.g. DSSS, OFDM, etc.). |
| Frequency band | 2400–2483.5 MHz |
| Frequency Min | 2402 (MHz) |
| Frequency Max | 2480 (MHz) |
| Channel numbers | 0–39 |
| RF power Max, Conducted | 3.08 mW (4.88 dBm) |
| Measured BW, 99% OBW | 1.03 (MHz) |
| Type of modulation | BLE (GFSK) |
| Emission classification | 1M03F1D |
| Transmitter spurious, @ 3 m | 50.74 dBµV/m (Average) |
| Antenna information | Printed circuit antenna, 3 dBi max for both Cellular radio and Bluetooth radio. |

5.5 EUT setup details

5.5.1 Radio exercise details

| | |
|----------------------|--|
| Operating conditions | EUT was specially modified for RF testing to transmit on the low, mid or/and high channels. Power Supply was used throughout the assessment. EUT came with RF connector and serial port for controlling. |
| Transmitter state | Transmitter set into continuous mode at low, mid and high channels. For Co-location verification the Cellular transmitter (operating within 2300–2690 MHz) and the BLE modules were powered ON and transmitting simultaneously. |

5.5.2 EUT setup configuration

Table 5.5-1: EUT sub assemblies

| Description | Brand name | Model, Part number, Serial number, Revision level |
|---------------------------|-----------------------|---|
| EUT with SMA connector | ORBCOMM License Corp. | PN: CT1000-0100-H, SN: JJKA4223600066, MN: CT1000 |
| EUT without SMA connector | ORBCOMM License Corp. | PN: CT1000-0100-H, SN: JJKA4223600069, MN: CT1000 |

Table 5.5-2: Support equipment

| Description | Brand name | Model, Part number, Serial number, Revision level |
|---------------------|--------------------|---|
| Laptop | Dell | None |
| STM32CubeMonitor-RF | STMicroelectronics | None |

Table 5.5-3: Inter-connection cables

| Cable description | From | To | Length (m) |
|-------------------|------|-------------------|------------|
| Clip on connector | EUT | Power Supply Unit | 0.5 |
| | EUT | Laoptop (PC) | 0.5 |

Note: The cables are only provided for testing purpose. The final product will not have any cables.

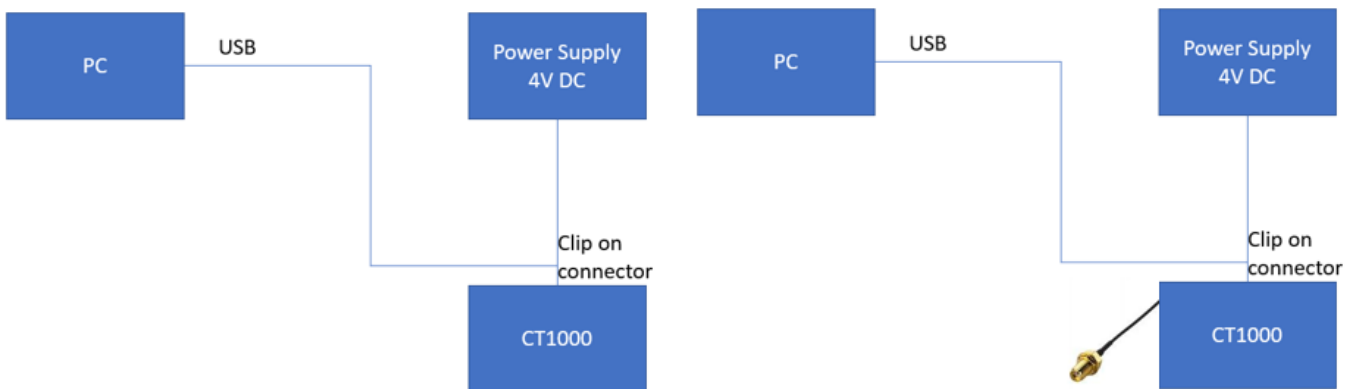

Figure 5.5-1: Radiated testing block diagram (Left) and Antenna port testing block diagram (Right)

Section 6 Summary of test results

6.1 Testing location

Test location (s) Ottawa

6.2 Testing period

Test start date September 13, 2022 Test end date October 14, 2022

6.3 Sample information

Receipt date September 9, 2022 Nemko sample ID number(s) 4843870001, 4843870002

6.4 FCC test results

Table 6.4-1: FCC requirements results

| Part | Test description | Verdict |
|----------------------------------|---|----------------|
| Generic requirements | | |
| §15.207(a) | Conducted limits | Not applicable |
| §15.31(e) | Variation of power source | Pass |
| §15.31(m) | Number of tested frequencies | Pass |
| §15.203 | Antenna requirement | Pass |
| §15.247(c)(1) | Fixed point-to-point operation with directional antenna gains greater than 6 dBi | Not applicable |
| §15.247(c)(2) | Transmitters operating in the 2400–2483.5 MHz band that emit multiple directional beams | Not applicable |
| §15.247(d) | Spurious emissions | Pass |
| DTS specific requirements | | |
| §15.247(a)(2) | Minimum 6 dB bandwidth | Pass |
| §15.247(b)(3) | Maximum peak output power | Pass |
| §15.247(e) | Power spectral density | Pass |

Notes: EUT is a battery operated device, the testing was performed using fresh batteries.

6.5 ISED test results

Table 6.5-1: ISED requirements results

| Part | Test description | Verdict |
|----------------------------------|--|-----------------------------|
| Generic requirements | | |
| RSS-Gen, 7.3 | Receiver radiated emission limits | Not applicable ¹ |
| RSS-Gen, 7.4 | Receiver conducted emission limits | Not applicable ¹ |
| RSS-Gen, 6.9 | Operating bands and selection of test frequencies | Pass |
| RSS-Gen, 8.8 | AC powerline conducted emissions limits | Not applicable ² |
| RSS-247, 5.5 | Unwanted emissions | Pass |
| DTS specific requirements | | |
| RSS-247, 5.2 (a) | Minimum 6 dB bandwidth | Pass |
| RSS-247, 5.2 (b) | Maximum power spectral density | Pass |
| RSS-247, 5.4 (d) | Transmitter output power and e.i.r.p. requirements for systems employing digital modulation techniques | Pass |
| RSS-247, 5.4 (e) | Point-to-point systems in 2400–2483.5 MHz and 5725–5850 MHz band | Not applicable |
| RSS-247, 5.4 (f) | Transmitters which operate in the 2400–2483.5 MHz band with multiple directional beams | Not applicable |

Notes: ¹According to sections 5.2 and 5.3 of RSS-Gen, Issue 5 the EUT does not have a stand-alone receiver neither scanner receiver, therefore exempt from receiver requirements.

²EUT is a battery operated device, the testing was performed using fresh batteries.

Section 7 Test equipment

7.1 Test equipment list

Table 7.1-1: Equipment list

| Equipment | Manufacturer | Model no. | Asset no. | Cal cycle | Next cal. |
|------------------------------|--------------------|--------------|-----------|-----------|-----------|
| 3 m EMI test chamber | TDK | SAC-3 | FA002047 | 1 year | 20-Jan-23 |
| Flush mount turntable | Sunol | FM2022 | FA002082 | — | NCR |
| Controller | Sunol | SC104V | FA002060 | — | NCR |
| Antenna mast | Sunol | TLT2 | FA002061 | — | NCR |
| Receiver/spectrum analyzer | Rohde & Schwarz | ESU 26 | FA002043 | 1 year | 25-Nov-22 |
| Horn (1–18 GHz) | ETS Lindgren | 3117 | FA002840 | 1 year | 10-Feb-23 |
| Preamp (1–18 GHz) | ETS Lindgren | 124334 | FA002873 | 1 year | 16-Aug-23 |
| Signal and Spectrum Analyzer | Rhode&Schwarz | FSW50 | FA003267 | 1 year | 29-Nov-22 |
| Bilog antenna (20–3000 MHz) | Sunol | JB3 | FA002108 | 1 year | 14-Feb-23 |
| Horn antenna (18–40 GHz) | EMCO | 3116 | FA001847 | 1 year | 06-Jun-23 |
| Pre-amplifier (18–26 GHz) | Narda | BBS-1826N612 | FA001550 | — | VOU |
| 50 Ω coax cable | C.C.A. | SF104B | FA003099 | 1 year | 03-May-23 |
| 2.4 GHz band Notch Filter | Microwave Circuits | N0324413 | FA003306 | — | 11-May-23 |

Notes: NCR - no calibration required, VOU - verify on use

Section 8 Testing data

8.1 Variation of power source

8.1.1 References, definitions and limits

FCC §15.31 (e):

For intentional radiators, measurements of the variation of the input power or the radiated signal level of the fundamental frequency component of the emission, as appropriate, shall be performed with the supply voltage varied between 85% and 115% of the nominal rated supply voltage. For battery operated equipment, the equipment tests shall be performed using a new battery.

8.1.2 Test summary

| | | | |
|-----------|------------------------|-----------|--------------------|
| Verdict | Pass | | |
| Tested by | Moustapha Salah Toubeh | Test date | September 13, 2022 |

8.1.3 Observations, settings and special notes

The testing was performed as per ANSI C63.10 Section 5.13.

- Where the device is intended to be powered from an external power adapter, the voltage variations shall be applied to the input of the adapter provided with the device at the time of sale. If the device is not marketed or sold with a specific adapter, then a typical power adapter shall be used.
- For devices, where operating at a supply voltage deviating $\pm 15\%$ from the nominal rated value may cause damages or loss of intended function, test to minimum and maximum allowable voltage per manufacturer's specification and document in the report.
- For devices with wide range of rated supply voltage, test at 15% below the lowest and 15% above the highest declared nominal rated supply voltage.
- For devices obtaining power from an input/output (I/O) port (USB, firewire, etc.), a test jig is necessary to apply voltage variation to the device from a support power supply, while maintaining the functionalities of the device.

For battery-operated equipment, the equipment tests shall be performed using a variable power supply.

8.1.4 Test data

| | | | |
|---|---|-----------------------------|---|
| EUT Power requirements: | <input type="checkbox"/> AC | <input type="checkbox"/> DC | <input checked="" type="checkbox"/> Battery |
| If EUT is an AC or a DC powered, was the noticeable output power variation observed? | <input type="checkbox"/> YES | <input type="checkbox"/> NO | <input checked="" type="checkbox"/> N/A |
| If EUT is battery operated, was the testing performed using fresh batteries? | <input checked="" type="checkbox"/> YES | <input type="checkbox"/> NO | <input type="checkbox"/> N/A |
| If EUT is rechargeable battery operated, was the testing performed using fully charged batteries? | <input type="checkbox"/> YES | <input type="checkbox"/> NO | <input checked="" type="checkbox"/> N/A |

8.2 Number of frequencies

8.2.1 References, definitions and limits

FCC §15.31:

- (m) Measurements on intentional radiators or receivers shall be performed and, if required, reported for each band in which the device can be operated with the device operating at the number of frequencies in each band specified in the following table.

RSS-Gen, Clause 6.9:

Except where otherwise specified, measurements shall be performed for each frequency band of operation for which the radio apparatus is to be certified, with the device operating at the frequencies in each band of operation shown in table below. The frequencies selected for measurements shall be reported in the test report.

Table 8.2-1: Frequency Range of Operation

| Frequency range over which the device operates (in each band) | Number of test frequencies required | Location of measurement frequency inside the operating frequency range |
|---|-------------------------------------|--|
| 1 MHz or less | 1 | Center (middle of the band) |
| 1–10 MHz | 2 | 1 near high end, 1 near low end |
| Greater than 10 MHz | 3 | 1 near high end, 1 near center and 1 near low end |

Notes: “near” means as close as possible to or at the centre / low end / high end of the frequency range over which the device operates.

8.2.2 Test summary

| | | | |
|-----------|------------------------|-----------|--------------------|
| Verdict | Pass | | |
| Tested by | Moustapha Salah Toubeh | Test date | September 13, 2022 |

8.2.3 Observations, settings and special notes

ANSI C63.10, Clause 5.6.2.1:

The number of channels tested can be reduced by measuring the center channel bandwidth first and then applying the following relaxations as appropriate:

- For each operating mode, if the measured channel bandwidth on the middle channel is at least 150% of the minimum permitted bandwidth, then it is not necessary to measure the bandwidth on the high and low channels.
- For multiple-input multiple-output (MIMO) systems, if the measured channel bandwidth on testing the middle channel exceeds the minimum permitted bandwidth by more than 50% on one transmit chain, then it is not necessary to repeat testing on the other chains.
- If the measured channel bandwidth on the middle channel is less than 50% of the maximum permitted bandwidth, then it is not necessary to measure the bandwidth on the high and low channels.

ANSI C63.10, Clause 5.6.2.2:

For devices with multiple operating modes, measurements on the middle channel can be used to determine the worst-case mode(s). The worst-case modes are as follows:

- Band edge requirements—Measurements on the mode with the widest bandwidth can be used to cover the same channel (center frequency) on modes with narrower bandwidth that have the same or lower output power for each modulation family (e.g., OFDM and direct sequence spread spectrum).
- Spurious emissions—Measure the mode with the highest output power and the mode with the highest output power spectral density for each modulation family (e.g., OFDM and direct sequence spread spectrum).
- In-band PSD—Measurements on the mode with the narrowest bandwidth can be used to cover all modes within the same modulation family of an equal or lower output power provided the result is less than 50% of the limit.



8.2.4 Test data

Table 8.2-2: *Test channels selection*

| Start of Frequency range, MHz | End of Frequency range, MHz | Frequency range bandwidth, MHz | Low channel, MHz | Mid channel, MHz | High channel, MHz |
|--------------------------------------|------------------------------------|---------------------------------------|-------------------------|-------------------------|--------------------------|
| 2400 | 2483.5 | 83.5 | 2402 | 2440 | 2480 |

8.3 Antenna requirement

8.3.1 References, definitions and limits

FCC §15.203:

An intentional radiator shall be designed to ensure that no antenna other than that furnished by the responsible party shall be used with the device. The use of a permanently attached antenna or of an antenna that uses a unique coupling to the intentional radiator shall be considered sufficient to comply with the provisions of this section. The manufacturer may design the unit so that a broken antenna can be replaced by the user, but the use of a standard antenna jack or electrical connector is prohibited. This requirement does not apply to intentional radiators that must be professionally installed, such as perimeter protection systems and some field disturbance sensors, or to other intentional radiators which, in accordance with §15.31(d), must be measured at the installation site. However, the installer shall be responsible for ensuring that the proper antenna is employed so that the limits in this part are not exceeded.

FCC §15.247:

- (b) The maximum peak conducted output power of the intentional radiator shall not exceed the following:
- (4) The conducted output power limit specified in paragraph (b) of this section is based on the use of antennas with directional gains that do not exceed 6 dBi. Except as shown in paragraph (c) of this section, if transmitting antennas of directional gain greater than 6 dBi are used, the conducted output power from the intentional radiator shall be reduced below the stated values in paragraphs (b)(1), (b)(2), and (b)(3) of this section, as appropriate, by the amount in dB that the directional gain of the antenna exceeds 6 dBi.

RSS-Gen, Clause 6.8:

The applicant for equipment certification shall provide a list of all antenna types that may be used with the transmitter, where applicable (i.e. for transmitters with detachable antenna), indicating the maximum permissible antenna gain (in dBi) and the required impedance for each antenna. The test report shall demonstrate the compliance of the transmitter with the limit for maximum equivalent isotropically radiated power (e.i.r.p.) specified in the applicable RSS, when the transmitter is equipped with any antenna type, selected from this list. For expediting the testing, measurements may be performed using only the antenna with highest gain of each combination of transmitter and antenna type, with the transmitter output power set at the maximum level. However, the transmitter shall comply with the applicable requirements under all operational conditions and when in combination with any type of antenna from the list provided in the test report.

8.3.2 Test summary

| | | | |
|-----------|------------------------|-----------|--------------------|
| Verdict | Pass | | |
| Tested by | Moustapha Salah Toubeh | Test date | September 13, 2022 |

8.3.3 Observations, settings and special notes

None

8.3.4 Test data

- Must the EUT be professionally installed? YES NO
- Does the EUT have detachable antenna(s)? YES NO
- If detachable, is the antenna connector(s) non-standard? YES NO N/A

Table 8.3-1: Antenna information

| Antenna type | Manufacturer | Model number | Maximum gain | Connector type |
|-----------------|--------------|--------------|--------------|----------------|
| Printed circuit | ORBCOMM | N/A | 3 dBi | N/A |

8.4 Minimum 6 dB bandwidth for DTS systems

8.4.1 References, definitions and limits

FCC §15.247:

- (a) Operation under the provisions of this Section is limited to frequency hopping and digitally modulated intentional radiators that comply with the following provisions:
- (2) Systems using digital modulation techniques may operate in the 902–928 MHz, 2400–2483.5 MHz, and 5725–5850 MHz bands. The minimum 6 dB bandwidth shall be at least 500 kHz.

RSS-247, Clause 5.2:

DTSs include systems that employ digital modulation techniques resulting in spectral characteristics similar to direct sequence systems. The following applies to the bands 902-928 MHz and 2400-2483.5 MHz:

- a. The minimum 6 dB bandwidth shall be 500 kHz.

RSS-Gen, Clause 6.7:

6 dB bandwidth is defined as the frequency range between two points, one at the lowest frequency below and one at the highest frequency above the carrier frequency, at which the maximum power level of the transmitted emission is attenuated 6 dB below the maximum in-band power level of the modulated signal, where the two points are on the outskirts of the in-band emission.

For the 99% emission bandwidth, the trace data points are recovered and directly summed in linear power level terms. The recovered amplitude data points, beginning at the lowest frequency, are placed in a running sum until 0.5% of the total is reached, and that frequency recorded. The process is repeated for the highest frequency data points (starting at the highest frequency, at the right side of the span, and going down in frequency). This frequency is then recorded. The difference between the two recorded frequencies is the occupied bandwidth (or the 99% emission bandwidth).

8.4.2 Test summary

| | | | |
|-----------|------------------------|-----------|--------------------|
| Verdict | Pass | | |
| Tested by | Moustapha Salah Toubeh | Test date | September 13, 2022 |

8.4.3 Observations, settings and special notes

The test was performed as per KDB 558074, section 8.2 with reference to ANSI C63.10 subclause 11.8.
 Spectrum analyser settings:

| | |
|----------------------|--|
| Resolution bandwidth | 6 dB BW: 100 kHz; 99% OBW: 1–5% of OBW |
| Video bandwidth | ≥3 × RBW |
| Frequency span | 1 MHz, 2 MHz |
| Detector mode | Peak |
| Trace mode | Max Hold |

8.4.4 Test data

Table 8.4-1: 6 dB bandwidth results

| Frequency, MHz | 6 dB bandwidth, kHz | Minimum limit, kHz | Margin, kHz |
|----------------|---------------------|--------------------|-------------|
| 2402 | 666.3 | 500.0 | 166.3 |
| 2440 | 666.3 | 500.0 | 166.3 |
| 2480 | 669.3 | 500.0 | 169.3 |

Table 8.4-2: 99% occupied bandwidth results

| Frequency, MHz | 99% occupied bandwidth, MHz |
|----------------|-----------------------------|
| 2402 | 1.03 |
| 2440 | 1.03 |
| 2480 | 1.03 |

Notes: There is no 99% occupied bandwidth limit in the standard's requirements, the measurement results provided for information purposes only.

Test data, continued

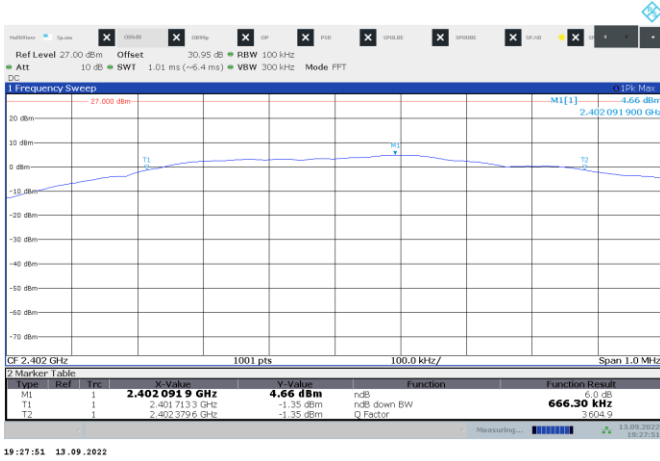

Figure 8.4-1: 6 dB bandwidth on BLE, Tx low channel

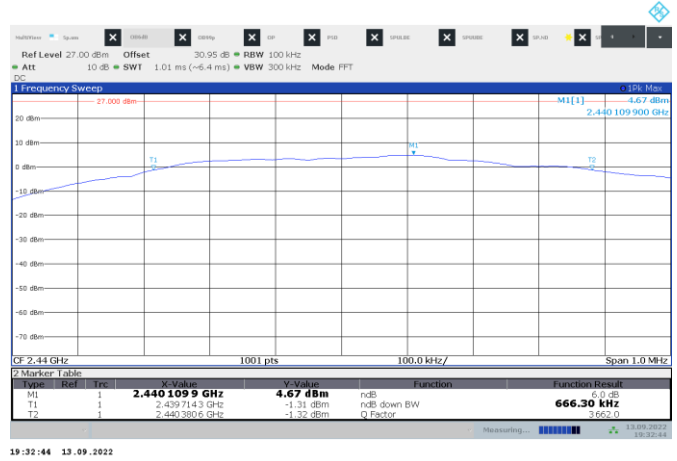

Figure 8.4-2: 6 dB bandwidth on BLE, Tx mid channel

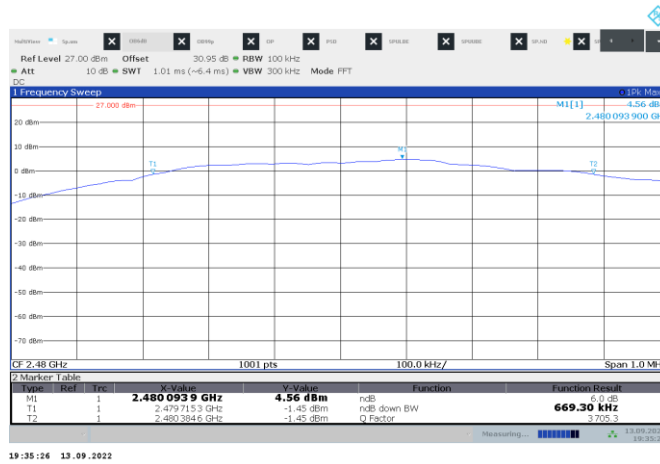

Figure 8.4-3: 6 dB bandwidth on BLE, Tx high channel

Test data, continued



Figure 8.4-4: 99% bandwidth on BLE, Tx low channel



Figure 8.4-5: 99% bandwidth on BLE, Tx mid channel



Figure 8.4-6: 99% bandwidth on BLE, Tx high channel

8.5 Transmitter output power and e.i.r.p. requirements for DTS in 2.4 GHz

8.5.1 References, definitions and limits

FCC §15.247:

- (b) The maximum peak conducted output power of the intentional radiator shall not exceed the following:
- (3) For systems using digital modulation in the 2400–2483.5 MHz band: 1 W (30 dBm). As an alternative to a peak power measurement, compliance with the one Watt limit can be based on a measurement of the maximum conducted output power. Maximum Conducted Output Power is defined as the total transmit power delivered to all antennas and antenna elements averaged across all symbols in the signaling alphabet when the transmitter is operating at its maximum power control level. Power must be summed across all antennas and antenna elements. The average must not include any time intervals during which the transmitter is off or is transmitting at a reduced power level. If multiple modes of operation are possible (e.g., alternative modulation methods), the maximum conducted output power is the highest total transmit power occurring in any mode.
- (4) The conducted output power limit specified in paragraph (b) of this section is based on the use of antennas with directional gains that do not exceed 6 dBi. Except as shown in paragraph (c) of this section, if transmitting antennas of directional gain greater than 6 dBi are used, the conducted output power from the intentional radiator shall be reduced below the stated values in paragraphs (b)(1), (b)(2), and (b)(3) of this section, as appropriate, by the amount in dB that the directional gain of the antenna exceeds 6 dBi.
- (c) Operation with directional antenna gains greater than 6 dBi.
 - (1) Fixed point-to-point operation:
 - (i) Systems operating in the 2400–2483.5 MHz band that are used exclusively for fixed, point-to-point operations may employ transmitting antennas with directional gain greater than 6 dBi provided the maximum conducted output power of the intentional radiator is reduced by 1 dB for every 3 dB that the directional gain of the antenna exceeds 6 dBi.
 - (iii) Fixed, point-to-point operation, as used in paragraphs (c)(1)(i) and (c)(1)(ii) of this section, excludes the use of point-to-multipoint systems, omnidirectional applications, and multiple co-located intentional radiators transmitting the same information. The operator of the spread spectrum or digitally modulated intentional radiator or, if the equipment is professionally installed, the installer is responsible for ensuring that the system is used exclusively for fixed, point-to-point operations. The instruction manual furnished with the intentional radiator shall contain language in the installation instructions informing the operator and the installer of this responsibility.
 - (2) In addition to the provisions in paragraphs (b)(1), (b)(3), (b)(4) and (c)(1)(i) of this section, transmitters operating in the 2400–2483.5 MHz band that emit multiple directional beams, simultaneously or sequentially, for the purpose of directing signals to individual receivers or to groups of receivers provided the emissions comply with the following:
 - (i) Different information must be transmitted to each receiver.
 - (ii) If the transmitter employs an antenna system that emits multiple directional beams but does not do emit multiple directional beams simultaneously, the total output power conducted to the array or arrays that comprise the device, i.e., the sum of the power supplied to all antennas, antenna elements, staves, etc. and summed across all carriers or frequency channels, shall not exceed the limit specified in paragraph (b)(1) or (b)(3) of this section, as applicable. However, the total conducted output power shall be reduced by 1 dB below the specified limits for each 3 dB that the directional gain of the antenna/antenna array exceeds 6 dBi. The directional antenna gain shall be computed as follows:
 - (A) The directional gain shall be calculated as the sum of $10 \log$ (number of array elements or staves) plus the directional gain of the element or stave having the highest gain.
 - (B) A lower value for the directional gain than that calculated in paragraph (c)(2)(ii)(A) of this section will be accepted if sufficient evidence is presented, e.g., due to shading of the array or coherence loss in the beamforming.
 - (iii) If a transmitter employs an antenna that operates simultaneously on multiple directional beams using the same or different frequency channels, the power supplied to each emission beam is subject to the power limit specified in paragraph (c)(2)(ii) of this section. If transmitted beams overlap, the power shall be reduced to ensure that their aggregate power does not exceed the limit specified in paragraph (c)(2)(ii) of this section. In addition, the aggregate power transmitted simultaneously on all beams shall not exceed the limit specified in paragraph (c)(2)(ii) of this section by more than 8 dB.
 - (iv) Transmitters that emit a single directional beam shall operate under the provisions of paragraph (c)(1) of this section.

References, definitions and limits, continued

RSS-247, Clause 5.4:

Devices shall comply with the following requirements, where applicable:

- d. For DTSs employing digital modulation techniques operating in the 2400–2483.5 MHz band,, the maximum peak conducted output power shall not exceed 1 W. The e.i.r.p. shall not exceed 4 W, except as provided in section 5.4(e).

As an alternative to a peak power measurement, compliance can be based on a measurement of the maximum conducted output power. The maximum conducted output power is the total transmit power delivered to all antennas and antenna elements, averaged across all symbols in the signalling alphabet when the transmitter is operating at its maximum power control level. Power must be summed across all antennas and antenna elements. The average must not include any time intervals during which the transmitter is off or transmitting at a reduced power level. If multiple modes of operation are implemented, the maximum conducted output power is the highest total transmit power occurring in any mode.

- e. Fixed point-to-point systems in the 2400–2483.5 MHz band are permitted to have an e.i.r.p. higher than 4 W provided that the higher e.i.r.p. is achieved by employing higher gain directional antennas and not higher transmitter output powers. Point-to-multipoint systems, omnidirectional applications and multiple co-located transmitters transmitting the same information are prohibited from exceeding an e.i.r.p. of 4 W.
- f. Transmitters operating in the band 2400–2483.5 MHz, may employ antenna systems that emit multiple directional beams simultaneously or sequentially, for the purpose of directing signals to individual receivers or to groups of receivers, provided that the emissions comply with the following:
 - i. Different information must be transmitted to each receiver.
 - ii. If the transmitter employs an antenna system that emits multiple directional beams, but does not emit multiple directional beams simultaneously, the total output power conducted to the array or arrays that comprise the device (i.e. the sum of the power supplied to all antennas, antenna elements, staves, etc., and summed across all carriers or frequency channels) shall not exceed the applicable output power limit specified in sections 5.4(b) and 5.4(d). However, the total conducted output power shall be reduced by 1 dB below the specified limits for each 3 dB that the directional gain of the antenna/antenna array exceeds 6 dBi. The directional antenna gain shall be computed as the sum of 10 log (number of array elements or staves) plus the directional gain of the element or stave having the highest gain.
 - iii. If a transmitter employs an antenna that operates simultaneously on multiple directional beams using the same or different frequency channels, the power supplied to each emission beam is subject to the applicable power limit specified in sections 5.4(b) and 5.4(d). If transmitted beams overlap, the power shall be reduced to ensure that their aggregate power does not exceed the applicable limit specified in sections 5.4(b) and 5.4(d). In addition, the aggregate power transmitted simultaneously on all beams shall not exceed the applicable limit specified in sections 5.4(b) and 5.4(d) by more than 8 dB.
 - iv. Transmitters that transmit a single directional beam shall operate under the provisions of sections 5.4(b), 5.4(d) and 5.4(e).

8.5.2 Test summary

| | | | |
|-----------|------------------------|-----------|--------------------|
| Verdict | Pass | | |
| Tested by | Moustapha Salah Toubeh | Test date | September 13, 2022 |

8.5.3 Observations, settings and special notes

The test was performed as per KDB 558074, section 8.3 with reference to ANSI C63.10 subclause 11.9.1 (peak power) using method RBW≥DTS bandwidth (Maximum peak conducted output power)

Spectrum analyser settings:

| | |
|----------------------|----------|
| Resolution bandwidth | 3 MHz |
| Video bandwidth | ≥3 × RBW |
| Frequency span | 10 MHz |
| Detector mode | Peak |
| Trace mode | Max hold |

8.5.4 Test data

Table 8.5-1: Output power and EIRP results (antenna port measurement)

| Frequency, MHz | Conducted output power, dBm | Output power limit, dBm | Output power margin, dB | Antenna gain, dBi | EIRP, dBm | EIRP limit, dBm | EIRP margin, dB |
|----------------|-----------------------------|-------------------------|-------------------------|-------------------|-----------|-----------------|-----------------|
| 2402 | 4.88 | 30.00 | 25.12 | 3.00 | 7.88 | 36.00 | 28.12 |
| 2440 | 4.86 | 30.00 | 25.14 | 3.00 | 7.86 | 36.00 | 28.14 |
| 2480 | 4.76 | 30.00 | 25.24 | 3.00 | 7.76 | 36.00 | 28.24 |

Note: EIRP [dBm] = Conducted output power [dBm] + Antenna gain [dBi]

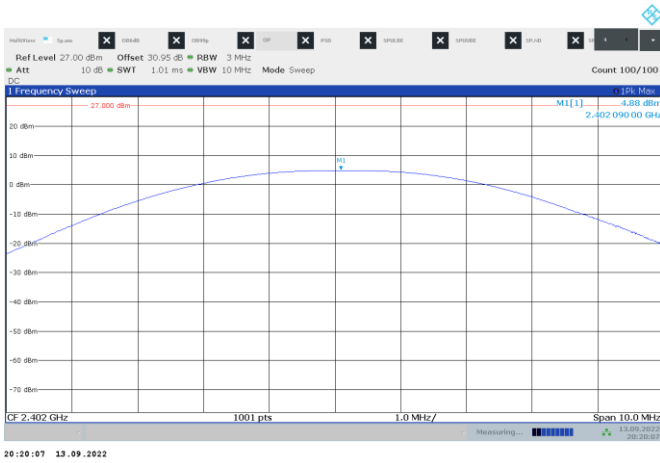

Figure 8.5-1: Output power on low channel

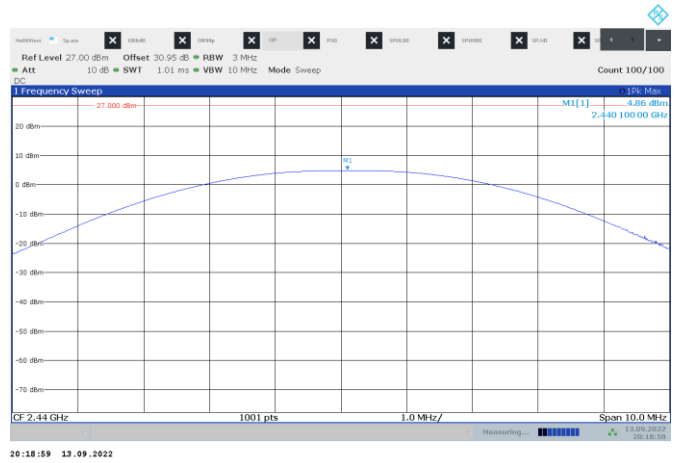

Figure 8.5-2: Output power on mid channel

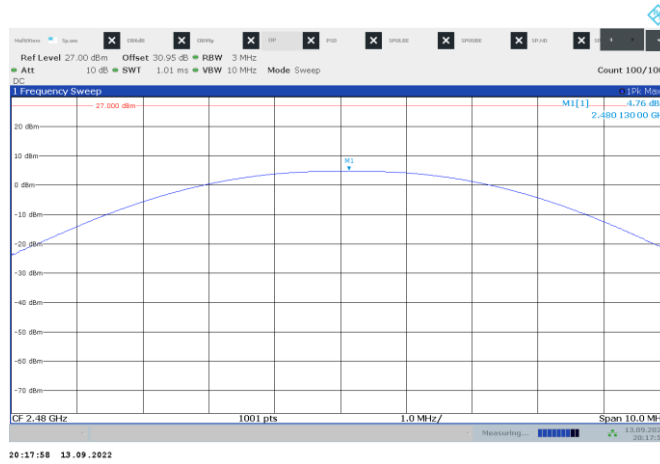

Figure 8.5-3: Output power on high channel

8.6 Spurious (out-of-band) unwanted emissions

8.6.1 References, definitions and limits

FCC §15.247:

- (d) In any 100 kHz bandwidth outside the frequency band in which the spread spectrum or digitally modulated intentional radiator is operating, the radio frequency power that is produced by the intentional radiator shall be at least 20 dB below that in the 100 kHz bandwidth within the band that contains the highest level of the desired power, based on either an RF conducted or a radiated measurement, provided the transmitter demonstrates compliance with the peak conducted power limits. If the transmitter complies with the conducted power limits based on the use of RMS averaging over a time interval, as permitted under paragraph (b)(3) of this section, the attenuation required under this paragraph shall be 30 dB instead of 20 dB. Attenuation below the general limits specified in §15.209(a) is not required. In addition, radiated emissions which fall in the restricted bands, as defined in §15.205(a), must also comply with the radiated emission limits specified in §15.209(a) (see §15.205(c)).

RSS-247, Clause 5.5:

In any 100 kHz bandwidth outside the frequency band in which the spread spectrum or digitally modulated device is operating, the RF power that is produced shall be at least 20 dB below that in the 100 kHz bandwidth within the band that contains the highest level of the desired power, based on either an RF conducted or a radiated measurement, provided that the transmitter demonstrates compliance with the peak conducted power limits. If the transmitter complies with the conducted power limits based on the use of root-mean-square averaging over a time interval, as permitted under section 5.4(d), the attenuation required shall be 30 dB instead of 20 dB. Attenuation below the general field strength limits specified in RSS-Gen is not required.

Table 8.6-1: FCC §15.209 and RSS-Gen – Radiated emission limits

| Frequency, MHz | Field strength of emissions | | Measurement distance, m |
|----------------|-----------------------------|---------------------------------|-------------------------|
| | µV/m | dBµV/m | |
| 0.009–0.490 | 2400/F | $67.6 - 20 \times \log_{10}(F)$ | 300 |
| 0.490–1.705 | 24000/F | $87.6 - 20 \times \log_{10}(F)$ | 30 |
| 1.705–30.0 | 30 | 29.5 | 30 |
| 30–88 | 100 | 40.0 | 3 |
| 88–216 | 150 | 43.5 | 3 |
| 216–960 | 200 | 46.0 | 3 |
| above 960 | 500 | 54.0 | 3 |

Notes: In the emission table above, the tighter limit applies at the band edges.
 For frequencies above 1 GHz the limit on peak RF emissions is 20 dB above the maximum permitted average emission limit applicable to the equipment under test.

References, definitions and limits, continued

Table 8.6-2: ISED restricted frequency bands

| MHz | MHz | MHz | GHz |
|-------------------|---------------------|---------------|-------------|
| 0.090–0.110 | 12.57675–12.57725 | 399.9–410 | 7.25–7.75 |
| 0.495–0.505 | 13.36–13.41 | 608–614 | 8.025–8.5 |
| 2.1735–2.1905 | 16.42–16.423 | 960–1427 | 9.0–9.2 |
| 3.020–3.026 | 16.69475–16.69525 | 1435–1626.5 | 9.3–9.5 |
| 4.125–4.128 | 16.80425–16.80475 | 1645.5–1646.5 | 10.6–12.7 |
| 4.17725–4.17775 | 25.5–25.67 | 1660–1710 | 13.25–13.4 |
| 4.20725–4.20775 | 37.5–38.25 | 1718.8–1722.2 | 14.47–14.5 |
| 5.677–5.683 | 73–74.6 | 2200–2300 | 15.35–16.2 |
| 6.215–6.218 | 74.8–75.2 | 2310–2390 | 17.7–21.4 |
| 6.26775–6.26825 | 108–138 | 2483.5–2500 | 22.01–23.12 |
| 6.31175–6.31225 | 149.9–150.05 | 2655–2900 | 23.6–24.0 |
| 8.291–8.294 | 156.52475–156.52525 | 3260–3267 | 31.2–31.8 |
| 8.362–8.366 | 156.7–156.9 | 3332–3339 | 36.43–36.5 |
| 8.37625–8.38675 | 162.0125–167.17 | 3345.8–3358 | |
| 8.41425–8.41475 | 167.72–173.2 | 3500–4400 | Above 38.6 |
| 12.29–12.293 | 240–285 | 4500–5150 | |
| 12.51975–12.52025 | 322–335.4 | 5350–5460 | |

Note: Certain frequency bands listed in Table 8.6-2 and above 38.6 GHz are designated for licence-exempt applications. These frequency bands and the requirements that apply to related devices are set out in the 200 and 300 series of RSSs.

Table 8.6-3: FCC restricted frequency bands

| MHz | MHz | MHz | GHz |
|-------------------|---------------------|---------------|-------------|
| 0.090–0.110 | 16.42–16.423 | 399.9–410 | 4.5–5.15 |
| 0.495–0.505 | 16.69475–16.69525 | 608–614 | 5.35–5.46 |
| 2.1735–2.1905 | 16.80425–16.80475 | 960–1240 | 7.25–7.75 |
| 4.125–4.128 | 25.5–25.67 | 1300–1427 | 8.025–8.5 |
| 4.17725–4.17775 | 37.5–38.25 | 1435–1626.5 | 9.0–9.2 |
| 4.20725–4.20775 | 73–74.6 | 1645.5–1646.5 | 9.3–9.5 |
| 6.215–6.218 | 74.8–75.2 | 1660–1710 | 10.6–12.7 |
| 6.26775–6.26825 | 108–121.94 | 1718.8–1722.2 | 13.25–13.4 |
| 6.31175–6.31225 | 123–138 | 2200–2300 | 14.47–14.5 |
| 8.291–8.294 | 149.9–150.05 | 2310–2390 | 15.35–16.2 |
| 8.362–8.366 | 156.52475–156.52525 | 2483.5–2500 | 17.7–21.4 |
| 8.37625–8.38675 | 156.7–156.9 | 2690–2900 | 22.01–23.12 |
| 8.41425–8.41475 | 162.0125–167.17 | 3260–3267 | 23.6–24.0 |
| 12.29–12.293 | 167.72–173.2 | 3332–3339 | 31.2–31.8 |
| 12.51975–12.52025 | 240–285 | 3345.8–3358 | 36.43–36.5 |
| 12.57675–12.57725 | 322–335.4 | 3600–4400 | Above 38.6 |
| 13.36–13.41 | | | |

8.6.2 Test summary

| | | | |
|-----------|------------------------|-----------|--|
| Verdict | Pass | | |
| Tested by | Moustapha Salah Toubeh | Test date | September 21, 2022 October 14, 2022 |

8.6.3 Observations, settings and special notes

- As part of the current assessment, the test range of 9 kHz to 10th harmonic has been fully considered and compared to the actual frequencies utilized within the EUT. Since the EUT contains a transmitter in the GHz range, the EUT has been deemed compliant without formal testing in the 9 kHz to 30 MHz test range, therefore formal test results (tabular data and/or plots) are not provided within this test report.
- Radiated measurements were performed at a distance of 3 m below 18 GHz and at a distance of 1 m above 18 GHz.
- DTS emissions in non-restricted frequency bands test was performed as per KDB 558074, section 8.5 with reference to ANSI C63.10 subclause 11.11.
- Since fundamental power was tested using the maximum peak conducted output power procedure to demonstrate compliance, the spurious emissions limit is –20 dBc/100 kHz.
- DTS emissions in restricted frequency bands test was performed as per KDB 558074, section 8.6 with reference to ANSI C63.10 subclause 11.12.
- DTS band-edge emission measurements test was performed as per KDB 558074, section 8.7 with reference to ANSI C63.10 subclause 11.13.
- EUT was set to transmit with industrial standard BT duty cycle.
- As a part of co-location testing, simultaneous operation of Cellular transmitter (operating within 2300–2690 MHz) and BLE transmitter was verified. No additional spurious emissions caused by the co-location were detected.

Spectrum analyser settings for radiated measurements within restricted bands below 1 GHz:

| | |
|-----------------------|----------|
| Resolution bandwidth: | 100 kHz |
| Video bandwidth: | 300 kHz |
| Detector mode: | Peak |
| Trace mode: | Max Hold |

Spectrum analyser settings for peak/average radiated measurements within restricted bands above 1 GHz:

| | |
|-----------------------|------------------|
| Resolution bandwidth: | 1 MHz |
| Video bandwidth: | 3 MHz |
| Detector mode: | Peak/RMS |
| Trace mode: | Max Hold/Average |

Spectrum analyser settings for conducted spurious emissions measurements:

| | |
|-----------------------|--|
| Resolution bandwidth: | 100 kHz below 1 GHz, 1 MHz above 1 GHz |
| Video bandwidth: | 300 kHz below 1 GHz, 3 MHz above 1 GHz |
| Detector mode: | Peak |
| Trace mode: | Max Hold |

8.6.4 Test data

Table 8.6-4: Radiated Field strength measurement results at band edge within restricted band

| Channel | Frequency, MHz | Peak Field strength, dB μ V/m | | Margin, dB | Average Field strength, dB μ V/m | | Margin, dB |
|---------|----------------|-----------------------------------|-------|------------|--------------------------------------|-------|------------|
| | | Measured | Limit | | Measured | Limit | |
| Low | 2390.00 | 49.59 | 74.00 | 24.41 | 48.97 | 54.00 | 5.03 |
| High | 2483.50 | 54.39 | 74.00 | 19.61 | 53.77 | 54.00 | 0.23 |

Notes: Field strength is obtained by applying following relation to convert dBm in dB μ V/m: $E(\text{dB}\mu\text{V}/\text{m}) = \text{EIRP}(\text{dBm}) - 20 \log_{10}(D) + 104.8$

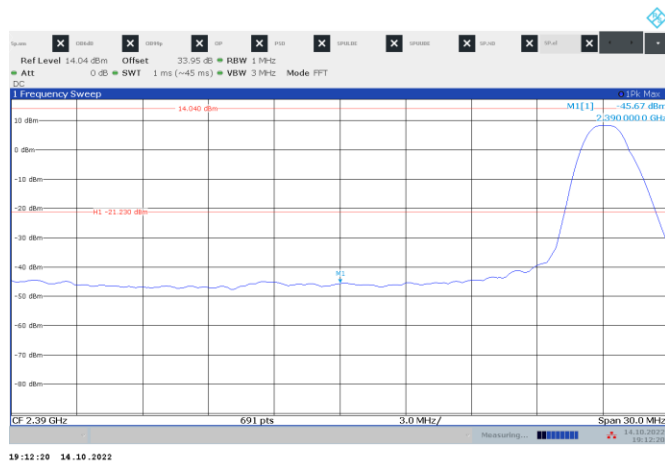

Figure 8.6-1: Conducted spurious emission at band edge within restricted band, TX on low channel, Peak

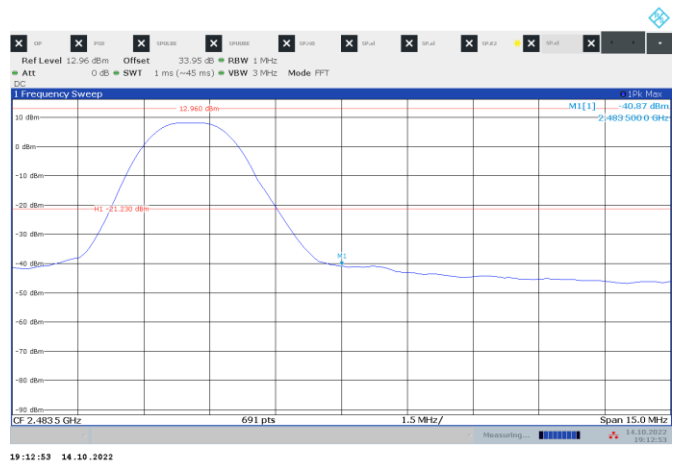

Figure 8.6-2: Conducted spurious emissions at band edge within restricted band, TX on High channel, Peak

Note: Peak limit EIRP equivalent: 74 dB μ V/m – 95.23 dB = –21.23 dBm
 Average limit EIRP equivalent: 54 dB μ V/m – 95.23 dB = –41.23 dBm
 Antenna-port conducted measurement was used as an alternative to radiated measurement, antenna gain of 3 dBi has been included in reference offset

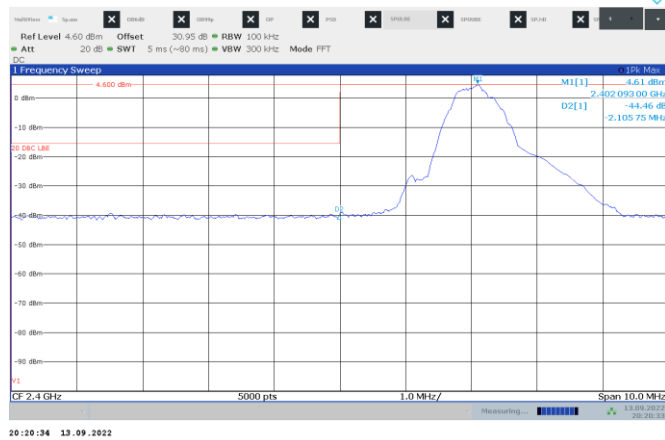

Figure 8.6-3: Conducted spurious emission at band edge outside restricted band, TX on low channel

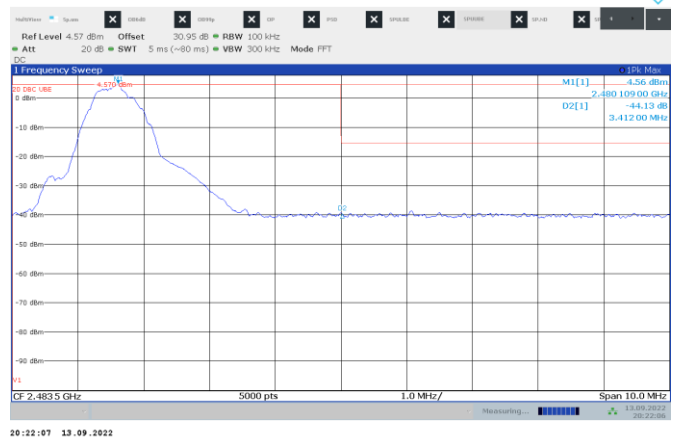

Figure 8.6-4: Conducted spurious emissions at band edge outside restricted band, TX on High channel

Test data, continued

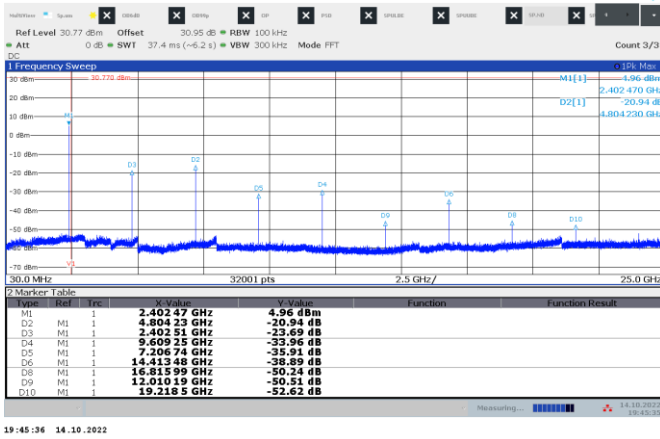

Figure 8.6-5: Conducted spurious emissions outside restricted band, TX on Low channel

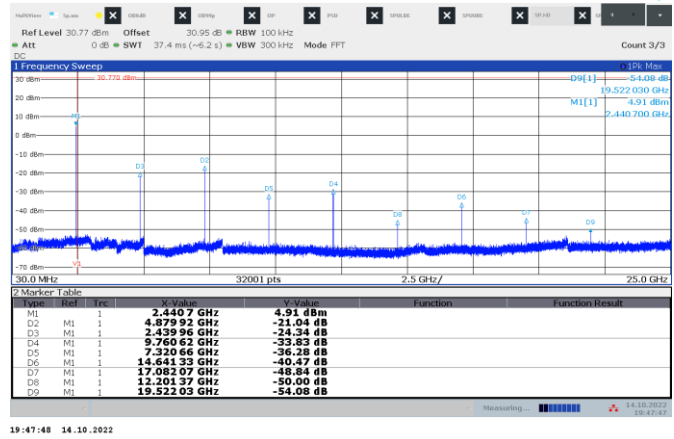

Figure 8.6-6: Conducted spurious emissions outside restricted band, TX on Mid channel

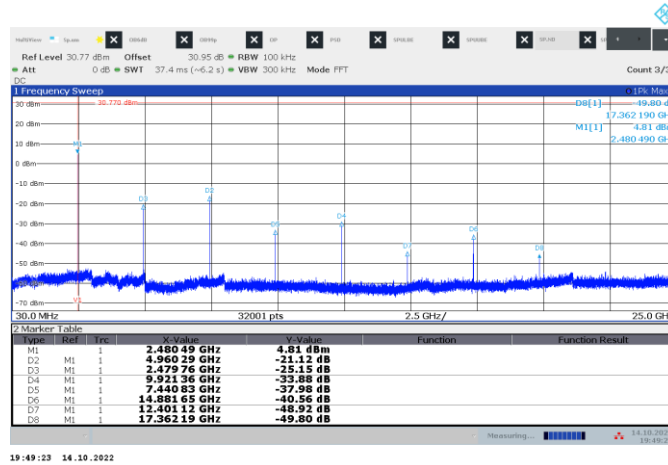

Figure 8.6-7: Conducted spurious emissions outside restricted band, TX on High channel

Test data, continued

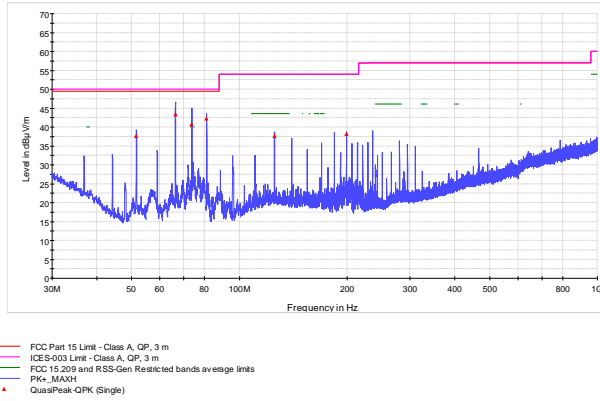

Figure 8.6-8: Radiated spurious emissions 30 MHz to 1 GHz – Sample plot

Note: The spikes are related to digital parts and are below the EMC standards (FCC part 15 and ICES-003 – Class A).

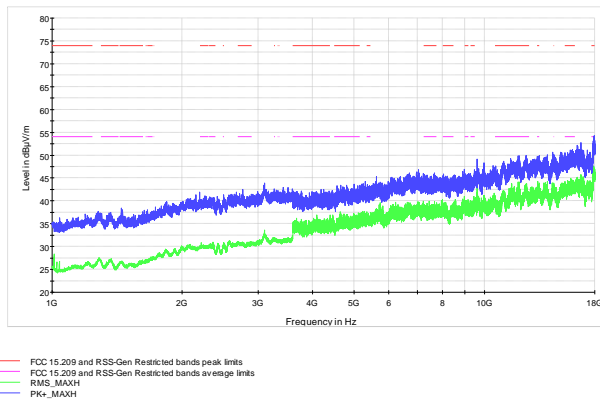

Figure 8.6-9: Radiated spurious emissions 1 GHz to 18 GHz – Sample plot

Test data, continued

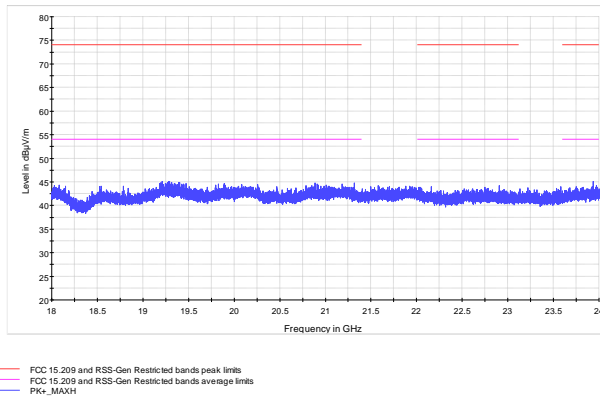

Figure 8.6-10: Radiated spurious emissions 18 GHz to 25 GHz – Sample plot

8.7 Power spectral density for digitally modulated devices

8.7.1 References, definitions and limits

FCC §15.247:

- (e) For digitally modulated systems, the power spectral density conducted from the intentional radiator to the antenna shall not be greater than 8 dBm in any 3 kHz band during any time interval of continuous transmission. This power spectral density shall be determined in accordance with the provisions of paragraph (b) of this section. The same method of determining the conducted output power shall be used to determine the power spectral density.
- (f) For the purposes of this section, hybrid systems are those that employ a combination of both frequency hopping and digital modulation techniques. The frequency hopping operation of the hybrid system, with the direct sequence or digital modulation operation turned-off, shall have an average time of occupancy on any frequency not to exceed 0.4 seconds within a time period in seconds equal to the number of hopping frequencies employed multiplied by 0.4. The power spectral density conducted from the intentional radiator to the antenna due to the digital modulation operation of the hybrid system, with the frequency hopping operation turned off, shall not be greater than 8 dBm in any 3 kHz band during any time interval of continuous transmission.

RSS-247, Clause 5.2:

DTSs include systems that employ digital modulation techniques resulting in spectral characteristics similar to direct sequence systems. The following applies to the bands 902-928 MHz and 2400-2483.5 MHz:

- b. The transmitter power spectral density conducted from the transmitter to the antenna shall not be greater than 8 dBm in any 3 kHz band during any time interval of continuous transmission. This power spectral density shall be determined in accordance with the provisions of section 5.4(d), (i.e. the power spectral density shall be determined using the same method as is used to determine the conducted output power).

RSS-247, Clause 5.3:

Hybrid systems employ a combination of both frequency hopping and digital transmission techniques and shall comply with the following:

- b. With the frequency hopping turned off, the digital transmission operation shall comply with the power spectral density requirements for digital modulation systems set out in of section 5.2(b) or section 6.2.4 for hybrid devices operating in the band 5725–5850 MHz.

8.7.2 Test summary

| | | | |
|-----------|------------------------|-----------|--------------------|
| Verdict | Pass | | |
| Tested by | Moustapha Salah Toubeh | Test date | September 13, 2022 |

8.7.3 Observations, settings and special notes

Power spectral density test was performed as per KDB 558074, section 8.4 with reference to ANSI C63.10 subclause 11.10.

The test was performed using method PKPSD (peak PSD).

Spectrum analyser settings:

| | |
|-----------------------|-----------------------------|
| Resolution bandwidth: | 100 kHz |
| Video bandwidth: | ≥3 × RBW |
| Frequency span: | 1.5 times the DTS BW (Peak) |
| Detector mode: | Peak |
| Trace mode: | Max hold |

8.7.4 Test data

Table 8.7-1: PSD results (antenna port measurement)

| Frequency, MHz | PSD, dBm/100 kHz | PSD limit, dBm/3 kHz | Margin, dB |
|----------------|------------------|----------------------|------------|
| 2402 | 4.66 | 8.00 | 3.34 |
| 2440 | 4.68 | 8.00 | 3.32 |
| 2480 | 4.57 | 8.00 | 3.43 |

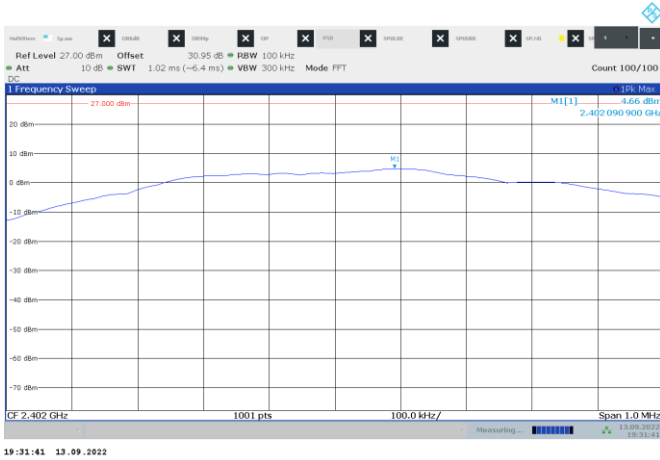

Figure 8.7-1: PSD on low channel

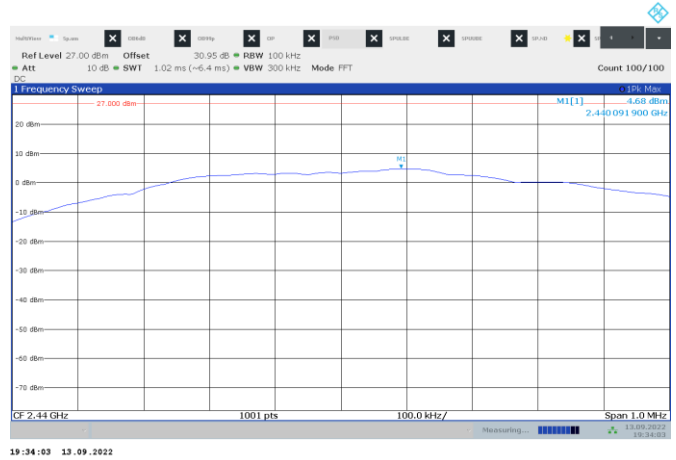

Figure 8.7-2: PSD on mid channel

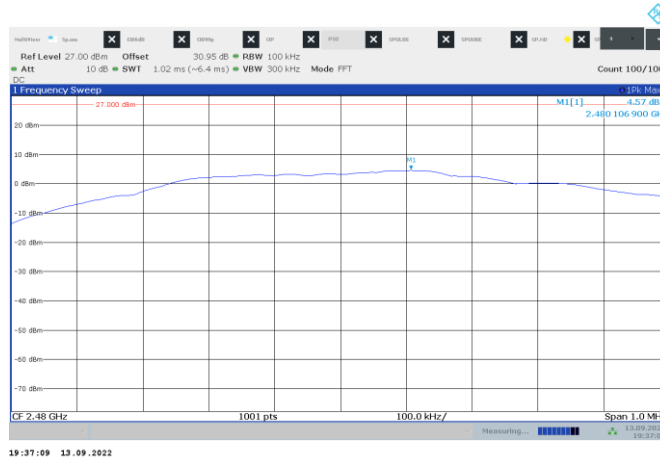

Figure 8.7-3: PSD on high channel

End of the test report