

Company: NetScout Systems Inc.

Test of: SENSOR4 Product Family
To: FCC CFR 47 Part 15 Subpart E 15.407

Report No.: NTCT77-U4 Rev B

CONDUCTED and RADIATED TEST REPORT





Test of: NetScout Systems Inc. SENSOR4 Product Family
to

To: FCC CFR 47 Part 15 Subpart E 15.407

Test Report Serial No.: NTCT77-U4 Rev B

This report supersedes: NTCT77-U4 Rev A

Applicant: NetScout Systems Inc.
178 E. Tasman Drive
San Jose, CA. 95134
USA

Product Function: Wireless LAN Client

Issue Date: 12th December 2016

This Test Report is Issued Under the Authority of:

MiCOM Labs, Inc.
575 Boulder Court
Pleasanton, California 94566
USA
Phone: +1 (925) 462-0304
Fax: +1 (925) 462-0306
www.micomlabs.com



MiCOM Labs is an ISO 17025 Accredited Testing Laboratory



Table of Contents

1. ACCREDITATION, LISTINGS & RECOGNITION.....	4
1.1. Testing Accreditation	4
1.2. Recognition	5
1.3. Product Certification	6
2. DOCUMENT HISTORY	7
3. TEST RESULT CERTIFICATE.....	8
4. REFERENCES AND MEASUREMENT UNCERTAINTY	9
4.1. Normative References	9
4.2. Test and Uncertainty Procedure	10
5. PRODUCT DETAILS AND TEST CONFIGURATIONS.....	11
Technical Details	11
Scope Of Test Program	12
5.1. Equipment Model(s) and Serial Number(s)	20
5.2. Antenna Details	20
5.3. Cabling and I/O Ports	21
5.4. Test Configurations.....	21
5.5. Equipment Modifications	21
5.6. Deviations from the Test Standard	21
6. TEST SUMMARY	22
7. TEST EQUIPMENT CONFIGURATION(S)	23
7.1. Radiated Emissions - 3m Chamber.....	23
7.2. Conducted	27
8. MEASUREMENT AND PRESENTATION OF TEST DATA	29
9. TEST RESULTS	30
9.1. Peak Transmit Power	30
9.2. 6 dB & 99% Bandwidth	35
9.3. Power Spectral Density	39
9.4. Radiated	44
9.4.1. <i>Restricted Band Emissions</i>	49
9.4.2. <i>Restricted Band-Edge Emissions 15.407</i>	57
9.4.3. <i>Restricted Band-Edge Emissions RSS 247</i>	63
PHOTOGRAPHS	69
A. APPENDIX - GRAPHICAL IMAGES	71
A.1. 6 dB & 99% Bandwidth	72
A.2. Power Spectral Density	96

This test report may be reproduced in full only. The document may only be updated by MiCOM Labs personnel. Any changes will be noted in the Document History section of the report.



Title: NetScout Systems Inc. SENSOR4 Product Family
To: FCC CFR 47 Part 15 Subpart E 15.407 & IC RSS-247
Serial #: NTCT77-U4 Rev B
Issue Date: 12th December 2016
Page: 4 of 128

1. ACCREDITATION, LISTINGS & RECOGNITION

1.1. Testing Accreditation

MiCOM Labs, Inc. is an accredited Electrical testing laboratory per the international standard ISO/IEC 17025:2005. The company is accredited by the American Association for Laboratory Accreditation (A2LA) www.a2la.org test laboratory number 2381.01. MiCOM Labs test schedule is available at the following URL; <http://www.a2la.org/scopepdf/2381-01.pdf>



Accredited Laboratory

A2LA has accredited

MICOM LABS

Pleasanton, CA

for technical competence in the field of

Electrical Testing

This laboratory is accredited in accordance with the recognized International Standard ISO/IEC 17025:2005 General requirements for the competence of testing and calibration laboratories. This accreditation demonstrates technical competence for a defined scope and the operation of a laboratory quality management system (refer to joint ISO-ILAC-IAF Communiqué dated 8 January 2009).



Presented this 4th day of February 2016.

Senior Director of Quality & Communications
For the Accreditation Council
Certificate Number 2381.01
Valid to November 30, 2017

For the tests or types of tests to which this accreditation applies, please refer to the laboratory's Electrical Scope of Accreditation.

This test report may be reproduced in full only. The document may only be updated by MiCOM Labs personnel. Any changes will be noted in the Document History section of the report.

MiCOM Labs, 575 Boulder Court, Pleasanton, CA 94566 USA, Phone: 925.462.0304, Fax: 925.462.0306, www.micomlabs.com



1.2. Recognition

MiCOM Labs, Inc has widely recognized wireless testing capabilities. Our international recognition includes Conformity Assessment Body designation by APEC MRA countries. MiCOM Labs test reports are accepted globally.

Country	Recognition Body	Status	Phase	Identification No.
USA	Federal Communications Commission (FCC)	TCB	-	US0159 Listing #: 102167
Canada	Industry Canada (IC)	FCB	APEC MRA 2	US0159 Listing #: 4143A-2 4143A-3
Japan	MIC (Ministry of Internal Affairs and Communication)	CAB	APEC MRA 2	RCB 210
	VCCI	--	--	A-0012
Europe	European Commission	NB	EU MRA	NB 2280
Australia	Australian Communications and Media Authority (ACMA)	CAB	APEC MRA 1	US0159
Hong Kong	Office of the Telecommunication Authority (OFTA)	CAB	APEC MRA 1	
Korea	Ministry of Information and Communication Radio Research Laboratory (RRL)	CAB	APEC MRA 1	
Singapore	Infocomm Development Authority (IDA)	CAB	APEC MRA 1	
Taiwan	National Communications Commission (NCC) Bureau of Standards, Metrology and Inspection (BSMI)	CAB	APEC MRA 1	
Vietnam	Ministry of Communication (MIC)	CAB	APEC MRA 1	

EU MRA – European Union Mutual Recognition Agreement.

NB – Notified Body

APEC MRA – Asia Pacific Economic Community Mutual Recognition Agreement. Recognition agreement under which test lab is accredited to regulatory standards of the APEC member countries.

Phase I - recognition for product testing

Phase II – recognition for both product testing and certification

This test report may be reproduced in full only. The document may only be updated by MiCOM Labs personnel. Any changes will be noted in the Document History section of the report.



Title: NetScout Systems Inc. SENSOR4 Product Family
To: FCC CFR 47 Part 15 Subpart E 15.407 & IC RSS-247
Serial #: NTCT77-U4 Rev B
Issue Date: 12th December 2016
Page: 6 of 128

1.3. Product Certification

MiCOM Labs, Inc. is an accredited Product Certification Body per the international standard ISO/IEC 17065:2012. The company is accredited by the American Association for Laboratory Accreditation (A2LA) www.a2la.org test laboratory number 2381.02. MiCOM Labs test schedule is available at the following URL; <http://www.a2la.org/scopepdf/2381-02.pdf>



Accredited Product Certification Body

A2LA has accredited

MICOM LABS

Pleasanton, CA

This product certification body is accredited in accordance with the recognized International Standard ISO/IEC 17065:2012 *Requirements for bodies certifying products, processes and services*. This accreditation demonstrates technical competence for a defined scope and the operation of a management system.



Presented this 4th day of February 2016.

Senior Director of Quality & Communications
For the Accreditation Council
Certificate Number 2381.02
Valid to November 30, 2017

For the product certification schemes to which this accreditation applies, please refer to the organization's Product Certification Scope of Accreditation.

United States of America – Telecommunication Certification Body (TCB)

Industry Canada – Certification Body, CAB Identifier – US0159

Europe – Notified Body (NB), NB Identifier - 2280

Japan – Recognized Certification Body (RCB), RCB Identifier - 210

This test report may be reproduced in full only. The document may only be updated by MiCOM Labs personnel. Any changes will be noted in the Document History section of the report.

MiCOM Labs, 575 Boulder Court, Pleasanton, CA 94566 USA, Phone: 925.462.0304, Fax: 925.462.0306, www.micomlabs.com



Title: NetScout Systems Inc. SENSOR4 Product Family
To: FCC CFR 47 Part 15 Subpart E 15.407 & IC RSS-247
Serial #: NTCT77-U4 Rev B
Issue Date: 12th December 2016
Page: 7 of 128

2. DOCUMENT HISTORY

Document History		
Revision	Date	Comments
Draft	14 th November 2016	Draft report for client review. Report underlines additional testing done due to enclosure change only and to show compliance per new requirements under 15.407. For complete test results see MiCOM Labs test report:
Rev A	21 November 2016	Initial release
Rev B	12th December 2016	Clarification of the scope of the test program.

In the above table the latest report revision will replace all earlier versions.

This test report may be reproduced in full only. The document may only be updated by MiCOM Labs personnel. Any changes will be noted in the Document History section of the report.



Title: NetScout Systems Inc. SENSOR4 Product Family
To: FCC CFR 47 Part 15 Subpart E 15.407 & IC RSS-247
Serial #: NTCT77-U4 Rev B
Issue Date: 12th December 2016
Page: 8 of 128

3. TEST RESULT CERTIFICATE

Manufacturer: NetScout Systems Inc 178 E. Tasman Drive San Jose, CA. 95134 USA	Tested By: MiCOM Labs, Inc. 575 Boulder Court Pleasanton California 94566 USA
Model: SENSOR4	Telephone: +1 925 462 0304 Fax: +1 925 462 0306
Type Of Equipment: 802.11 a/b/g/n	
S/N's: 16291348	
Test Date(s): 31 st October – November 7 th 2016	Website: www.micomlabs.com

STANDARD(S)	TEST RESULTS
FCC CFR 47 Part 15 Subpart E 15.407 & IC RSS 247	EQUIPMENT COMPLIES

MiCOM Labs, Inc. tested the equipment mentioned in accordance with the requirements set forth in the above standards. Test results indicate that the equipment tested is capable of demonstrating compliance with the requirements as documented within this report.

Notes:

1. This document reports conditions under which testing was conducted and the results of testing performed.
2. Details of test methods used have been recorded and kept on file by the laboratory.
3. Test results apply only to the item(s) tested.

Approved & Released for MiCOM Labs, Inc. by:



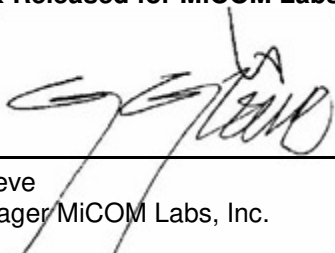

Graeme Grieve
Quality Manager MiCOM Labs, Inc.

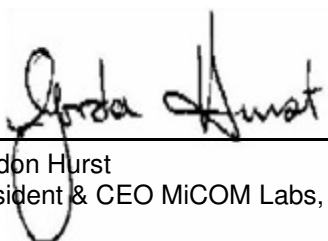

Gordon Hurst
President & CEO MiCOM Labs, Inc.

This test report may be reproduced in full only. The document may only be updated by MiCOM Labs personnel. Any changes will be noted in the Document History section of the report.



4. REFERENCES AND MEASUREMENT UNCERTAINTY

4.1. Normative References

REF.	PUBLICATION	YEAR	TITLE
I	KDB 662911 D01 & D02	Oct 31 2013	Guidance for measurement of output emission of devices that employ single transmitter with multiple outputs or systems with multiple transmitters operating simultaneously in the same frequency band
II	KDB 905462 D07 v02	22 nd August 2016	Test guidance to demonstrate compliance for U-NII devices subject to DFS requirements.
III	KDB 926956 D01 v02	22 nd August 2016	U-NII Device Transition Plan
IV	KDB 789033 D02 v01r03	22 nd August 2016	General UNII Test Procedures New Rules
V	A2LA	June 2015	R105 - Requirement's When Making Reference to A2LA Accreditation Status
VI	ANSI C63.10	2013	American National Standard for Testing Unlicensed Wireless Devices
VII	ANSI C63.4	2014	American National Standards for Methods of Measurement of Radio-Noise Emissions from Low-Voltage Electrical and Electronic Equipment in the Range of 9 kHz to 40 GHz
VIII	CISPR 22	2008	Information technology equipment - Radio disturbance characteristics - Limits and methods of measurement
IX	ETSI TR 100 028	2001-12	Parts 1 and 2 Electromagnetic compatibility and Radio Spectrum Matters (ERM); Uncertainties in the measurement of mobile radio equipment characteristics
X	FCC 06-96	Jun 30 2006	Memorandum Opinion and Order
XI	FCC 47 CFR Part 15.407	2014	Radio Frequency Devices; Subpart E –Unlicensed National Information Infrastructure Devices
XII	ICES-003	Issue 6 Jan 2016	Spectrum Management and Telecommunications; Interference-Causing Equipment Standard. Information Technology Equipment (Including Digital Apparatus) – Limits and methods of measurement.
XIII	M 3003	Edition 3 Nov.2012	Expression of Uncertainty and Confidence in Measurements
XIV	RSS-247 Issue 1	May 2015	Digital Transmission Systems (DTSS), Frequency Hopping System (FHSs) and Licence-Exempt Local Area Network (LE-LEN) Devices
XV	RSS-Gen Issue 4	November 2014	General Requirements and Information for the Certification of Radiocommunication Equipment
XVI	KDB 644545 D03 v01	August 14th 2014	Guidance for IEEE 802.11ac New Rules
XVII	FCC 47 CFR Part 2.1033	2014	FCC requirements and rules regarding photographs and test setup diagrams.
XVIII	EN 55022	2010 + AC:2011	Information technology equipment - Radio disturbance characteristics - Limits and methods of measurement

This test report may be reproduced in full only. The document may only be updated by MiCOM Labs personnel. Any changes will be noted in the Document History section of the report.



Title: NetScout Systems Inc. SENSOR4 Product Family
To: FCC CFR 47 Part 15 Subpart E 15.407 & IC RSS-247
Serial #: NTCT77-U4 Rev B
Issue Date: 12th December 2016
Page: 10 of 128

4.2. Test and Uncertainty Procedure

Conducted and radiated emission measurements were conducted in accordance with American National Standards Institute ANSI C63.4, listed in the Normative References section of this report.

Measurement uncertainty figures are calculated in accordance with ETSI TR 100 028 Parts 1 and 2.

Measurement uncertainties stated are based on a standard uncertainty multiplied by a coverage factor $k = 2$, providing a level of confidence of approximately 95 % in accordance with UKAS document M 3003 listed in the Normative References section of this report.

This test report may be reproduced in full only. The document may only be updated by MiCOM Labs personnel. Any changes will be noted in the Document History section of the report.



Title: NetScout Systems Inc. SENSOR4 Product Family
To: FCC CFR 47 Part 15 Subpart E 15.407 & IC RSS-247
Serial #: NTCT77-U4 Rev B
Issue Date: 12th December 2016
Page: 11 of 128

5. PRODUCT DETAILS AND TEST CONFIGURATIONS

Technical Details

Details	Description
Purpose:	Test of the NetScout Systems Inc SENSOR4 Family Product to FCC CFR 47 Part 15 Subpart E 15.407. Radio Frequency Devices; Subpart E –Unlicensed National Information Infrastructure Devices. Updating report to include new requirements per 15.407.
Applicant:	NetScout Systems Inc 178 E. Tasman Drive San Jose, CA. 95134
Manufacturer:	Netcout Systems Inc.
Laboratory performing the tests:	MiCOM Labs, Inc. 575 Boulder Court Pleasanton California 94566 USA
Test report reference number:	NTCT77-U4 Rev B
Date EUT received:	28 th October 2016
Standard(s) applied:	FCC CFR 47 Part 15 Subpart E 15.407
Dates of test (from - to):	31 st October – November 7 th 2016
No of Units Tested:	1
Type of Equipment:	802.11 a/b/g/n
Product Family Name:	Wireless Client
Model(s):	Sensor4-R2S1-I, Sensor4-R2S1-E, Sensor4-R1S1W1-E
Location for use:	Indoor
Declared Frequency Range(s):	5150 - 5250 MHz; 5250 - 5350 MHz; 5470 - 5725 MHz; 5725 - 5850 MHz;
Primary function of equipment:	Wireless Client, 3x3 Spatial Multiplexing MIMO Configuration
Secondary function of equipment:	Not Provided
Type of Modulation:	OFDM
EUT Modes of Operation:	5725 - 5850 MHz: 802.11a; 802.11n HT-20; 802.11n HT-40;
Transmit/Receive Operation:	Transceiver - Full Duplex
Rated Input Voltage and Current:	POE (POE adaptor NOT sold with unit) 48Vdc
Operating Temperature Range:	Declared Range 0°C to 55°C
ITU Emission Designator:	5725 – 5850 MHz 802.11a 33M9D1D 5725 – 5850 MHz 802.11n HT-20 34M4D1D 5725 – 5850 MHz 802.11n HT-40 69M4D1D
Equipment Dimensions:	7.5" x 7.5" x 1.5"
Weight:	1 lb (0.454 Kg)
Hardware Rev:	assembly rev 5, pcb rev 3
Software Rev:	Build 35232

This test report may be reproduced in full only. The document may only be updated by MiCOM Labs personnel. Any changes will be noted in the Document History section of the report.



Title: NetScout Systems Inc. SENSOR4 Product Family
To: FCC CFR 47 Part 15 Subpart E 15.407 & IC RSS-247
Serial #: NTCT77-U4 Rev B
Issue Date: 12th December 2016
Page: 12 of 128

Scope Of Test Program

The SENSOR4 wireless client was originally tested in the 5725 – 5850 MHz band by MiCOM Labs for compliance against FCC 47 CFR Part 15.247 and Industry Canada RSS-210 specifications in 2012 with updates in 2013 when testing was reported in MiCOM Labs in FLUK07-U2 report in November 2013.

The scope of this test program was to test the NetScout Systems Inc. SENSOR4 Product Family, 802.11 a/b/g/n Wireless client configurations in the frequency ranges 5725 - 5850 MHz; for compliance against FCC 47 CFR Part 15.407 and Industry Canada RSS-247 specifications to cover the following changes;-

1. Addressing the requirements for UNII3, 5.8GHz band for FCC now under part 15.407.
2. Radiated Emission compliance as a result of changes to the enclosure.

This test report may be reproduced in full only. The document may only be updated by MiCOM Labs personnel. Any changes will be noted in the Document History section of the report.



NetScout Systems Inc SENSOR4 Product Family

The SENSOR4 wireless client can be marketed using a number of different models.

The product was originally tested and certified in 2012 and 2013 for the 12 model variants listed in the table below.

Sensor Model	Features
SENSOR4-R1S0-I	AIRMAGNET SENSOR, 4TH GEN, 1 X 11N RADIO, INTERNAL ANTENNA.
SENSOR4-R1S1-I	AIRMAGNET SPECTRUM SENSOR, 4TH GEN, 1 X 11N RADIO, INTERNAL ANTENNA.
SENSOR4-R2S0-I	AIRMAGNET SENSOR, 4TH GEN, 2 X 11N RADIO, INTERNAL ANTENNA.
SENSOR4-R2S1-I	AIRMAGNET SPECTRUM SENSOR, 4TH GEN, 2 X 11N RADIO, INTERNAL ANTENNA.
SENSOR4-R1S0-E	AIRMAGNET SENSOR, 4TH GEN, 1 X 11N RADIO 4 EXTERNAL ANTENNAS.
SENSOR4-R1S1-E	AIRMAGNET SPECTRUM SENSOR, 4TH GEN, 1 X 11N RADIO 4 EXTERNAL ANTENNAS.
SENSOR4-R2S0-E	AIRMAGNET SENSOR, 4TH GEN, 2 X 11N RADIO 8 EXTERNAL ANTENNAS.
SENSOR4-R2S1-E	AIRMAGNET SPECTRUM SENSOR, 4TH GEN, 2 X 11N RADIO 8 EXTERNAL ANTENNAS.
SENSOR4-R1S1W1-E	AIRMAGNET WIFI SPECTRUM SENSOR, 4TH GEN, 1 x 11N Radio, CELLULAR SPECTRUM, 5 EXTERNAL ANTENNAS
SENSOR4-R1S0W1-E	AIRMAGNET SENSOR, 4TH GEN, 1 x 11N Radio, CELLULAR SPECTRUM, 5 EXTERNAL ANTENNAS
SENSOR4-R0S0W1-E	AIRMAGNET SENSOR, 4TH GEN, 1 x 11N Radio, CELLULAR SPECTRUM, 1 EXTERNAL ANTENNA
SENSOR4-R0S1W0-E	AIRMAGNET WIFI SPECTRUM SENSOR, 1 EXTERNAL ANTENNA

The test results reported in this document test worst case fully loaded configurations;

- SENSOR4-R2S1-E (external antenna)
- SENSOR4-R2S1-I (integral antenna)
- SENSOR4-R1S1W1-E (external antenna)

NetScout Systems Inc. SENSOR4 Product Family Cellular version; External Top View



This test report may be reproduced in full only. The document may only be updated by MiCOM Labs personnel. Any changes will be noted in the Document History section of the report.



Title: NetScout Systems Inc. SENSOR4 Product Family
To: FCC CFR 47 Part 15 Subpart E 15.407 & IC RSS-247
Serial #: NTCT77-U4 Rev B
Issue Date: 12th December 2016
Page: 15 of 128

NetScout Systems Inc. SENSOR4 Product Family Cellular version; External Bottom View

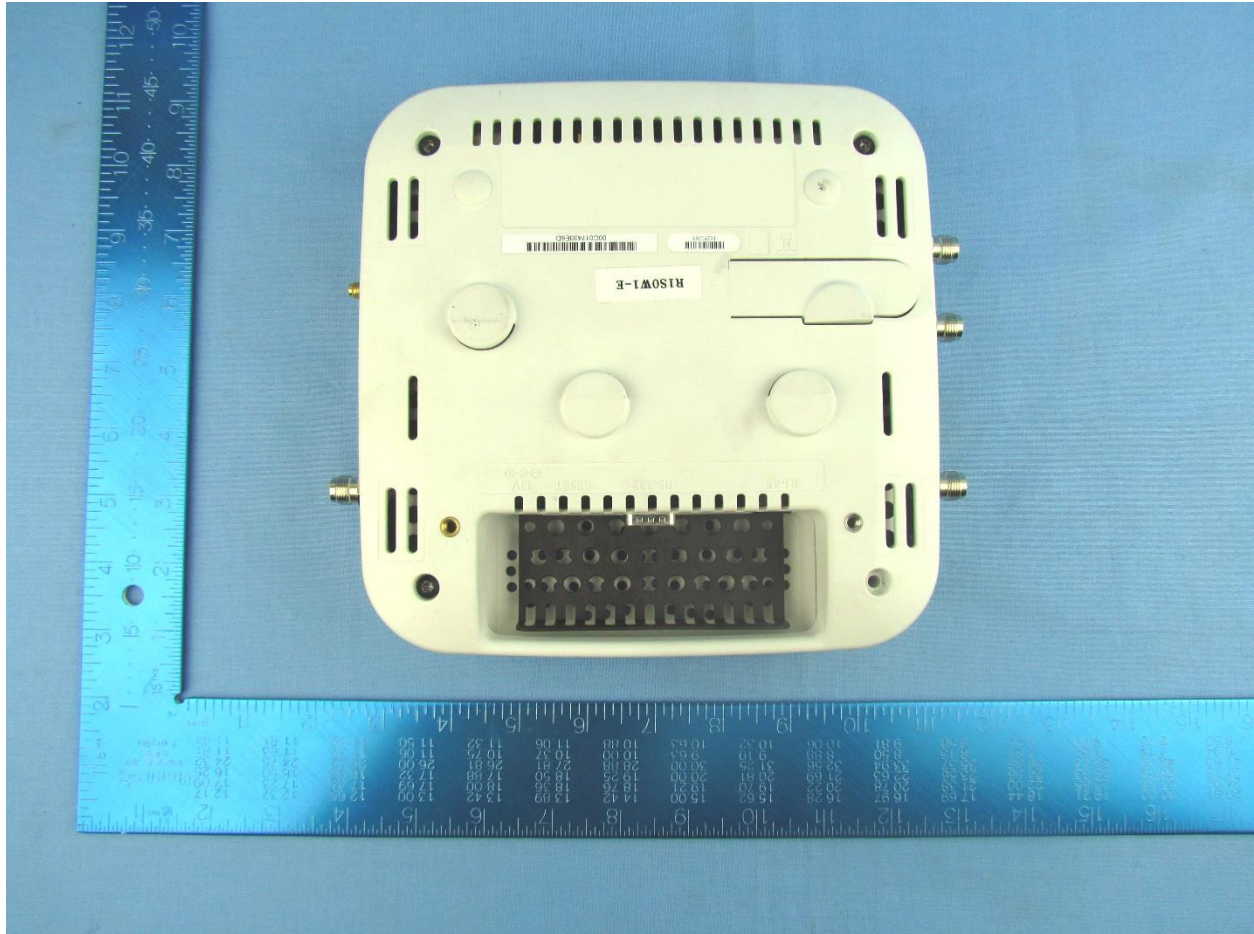

This test report may be reproduced in full only. The document may only be updated by MiCOM Labs personnel. Any changes will be noted in the Document History section of the report.



Title: NetScout Systems Inc. SENSOR4 Product Family
To: FCC CFR 47 Part 15 Subpart E 15.407 & IC RSS-247
Serial #: NTCT77-U4 Rev B
Issue Date: 12th December 2016
Page: 16 of 128

NetScout Systems Inc. SENSOR4 Product Family Cellular version; Front View



This test report may be reproduced in full only. The document may only be updated by MiCOM Labs personnel. Any changes will be noted in the Document History section of the report.



Title: NetScout Systems Inc. SENSOR4 Product Family
To: FCC CFR 47 Part 15 Subpart E 15.407 & IC RSS-247
Serial #: NTCT77-U4 Rev B
Issue Date: 12th December 2016
Page: 17 of 128

NetScout Systems Inc. SENSOR4 Product Family Cellular version; External rear View



This test report may be reproduced in full only. The document may only be updated by MiCOM Labs personnel. Any changes will be noted in the Document History section of the report.



Title: NetScout Systems Inc. SENSOR4 Product Family
To: FCC CFR 47 Part 15 Subpart E 15.407 & IC RSS-247
Serial #: NTCT77-U4 Rev B
Issue Date: 12th December 2016
Page: 18 of 128

NetScout Systems Inc. SENSOR4 Product Family Cellular version; External Left View



This test report may be reproduced in full only. The document may only be updated by MiCOM Labs personnel. Any changes will be noted in the Document History section of the report.



Title: NetScout Systems Inc. SENSOR4 Product Family
To: FCC CFR 47 Part 15 Subpart E 15.407 & IC RSS-247
Serial #: NTCT77-U4 Rev B
Issue Date: 12th December 2016
Page: 19 of 128

NetScout Systems Inc. SENSOR4 Product Family Cellular version; External Right View



This test report may be reproduced in full only. The document may only be updated by MiCOM Labs personnel. Any changes will be noted in the Document History section of the report.



5.1. Equipment Model(s) and Serial Number(s)

Type (EUT/Support)	Equipment Description (Including Brand Name)	Mfr	Model No.	Serial No.
EUT	802.11a/b/g/n	NetScout System Inc.	SENSOR4-R1S1W1-E	16291348
Support	Laptop PC	Dell	E6420	None

5.2. Antenna Details

Type	Manufacturer	Model	Family	Gain (dBi)	BF Gain	Dir BW	X-Pol	Frequency Band (MHz)
integral	Laird	Laird NanoGreen	Folded Dipole	4.8	-	360	-	5150 - 5250
integral	Laird	Laird NanoGreen	Folded Dipole	4.8	-	360	-	5250 - 5350
integral	Laird	Laird NanoGreen	Folded Dipole	4.8	-	360	-	5470 - 5725
integral	Laird	Laird NanoGreen	Folded Dipole	4.8	-	360	-	5725 - 5850
integral	Laird	Laird NanoGreen	Folded Dipole	4.8	-	360	-	5725 - 5850
external	Omni Rubber Duck	Wanshih SQ1WFI0001A	Dipole	2.0	-	360	-	5150 - 5250
external	Omni Rubber Duck	Wanshih SQ1WFI0001A	Dipole	2.0	-	360	-	5250 - 5350
external	Omni Rubber Duck	Wanshih SQ1WFI0001A	Dipole	2.0	-	360	-	5470 - 5725
external	Omni Rubber Duck	Wanshih SQ1WFI0001A	Dipole	2.0	-	360	-	5725 - 5850
external	Omni Rubber Duck	Wanshih SQ1WFI0001A	Dipole	2.0	-	360	-	5725 - 5850

BF Gain - Beamforming Gain
Dir BW - Directional BeamWidth
X-Pol - Cross Polarization

This test report may be reproduced in full only. The document may only be updated by MiCOM Labs personnel. Any changes will be noted in the Document History section of the report.



5.3. Cabling and I/O Ports

1	DB9	RS-232 serial console port
2	RJ-45	Ethernet + PoE
3	dc jack	12Vdc power in
4	reset	reset push button
5	RP-TNC	Reverse polarity - TNC RF antenna connector

5.4. Test Configurations

Results for the following configurations are provided in this report:

Operational Mode(s) (802.11a/b/g/n)	Data Rate with Highest Power MBit/s	Channel Frequency (MHz)		
		Low	Mid	High
5725 - 5850 MHz				
802.11a	6.00	5745.00	5785.00	5825.00
802.11n HT-20	6.50	5745.00	5785.00	5825.00
802.11n HT-40	13.50	5755.00	--	5795.00

Radiated emission results are included for all 5GHz UNII bands to verify emission compliance as results of changes to the enclosure.

5.5. Equipment Modifications

The following modifications were required to bring the equipment into compliance:

1. NONE

5.6. Deviations from the Test Standard

The following deviations from the test standard were required in order to complete the test program:

1. NONE

This test report may be reproduced in full only. The document may only be updated by MiCOM Labs personnel. Any changes will be noted in the Document History section of the report.



Title: NetScout Systems Inc. SENSOR4 Product Family
To: FCC CFR 47 Part 15 Subpart E 15.407 & IC RSS-247
Serial #: NTCT77-U4 Rev B
Issue Date: 12th December 2016
Page: 22 of 128

6. TEST SUMMARY

List of Measurements

Test Header	Result	Data Link
Peak Transmit Power	Complies	View Data
6 dB & 99% Bandwidth	Complies	View Data
Power Spectral Density	Complies	View Data
Restricted Band Emissions	Complies	View Data
Restricted Band Edge per 15.407	Complies	View Data
Restricted Band Edge per IC RSS 247	Complies	View Data

This test report may be reproduced in full only. The document may only be updated by MiCOM Labs personnel. Any changes will be noted in the Document History section of the report.



Title: NetScout Systems Inc. SENSOR4 Product Family
To: FCC CFR 47 Part 15 Subpart E 15.407 & IC RSS-247
Serial #: NTCT77-U4 Rev B
Issue Date: 12th December 2016
Page: 23 of 128

7. TEST EQUIPMENT CONFIGURATION(S)

7.1. Radiated Emissions - 3m Chamber

The following tests were performed using the radiated test set-up shown in the diagram below.

Radiated emissions below 1GHz.; and Radiated Emissions above 1GHz.

This test report may be reproduced in full only. The document may only be updated by MiCOM Labs personnel. Any changes will be noted in the Document History section of the report.

MiCOM Labs, 575 Boulder Court, Pleasanton, CA 94566 USA, Phone: 925.462.0304, Fax: 925.462.0306, www.micomlabs.com

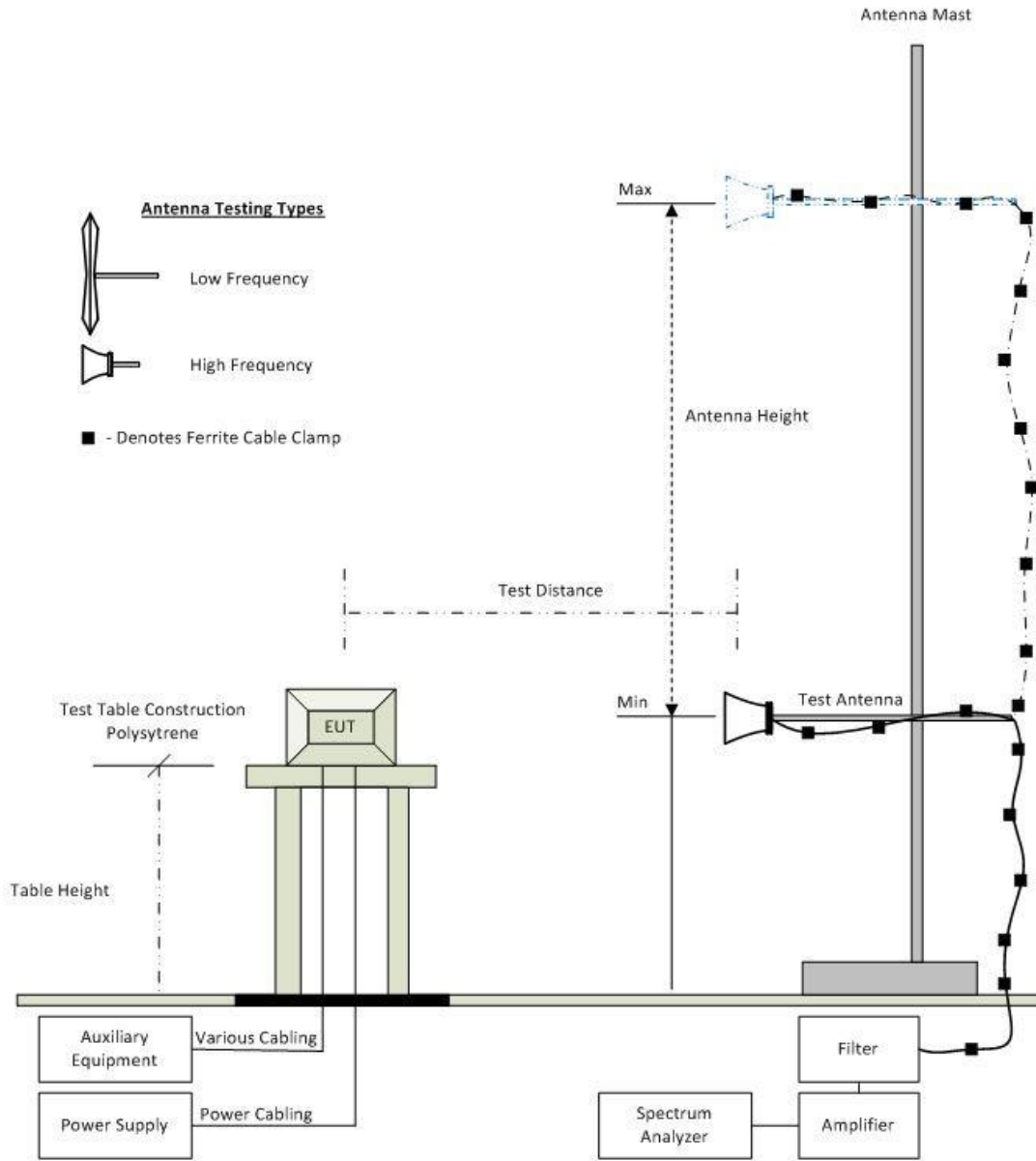

Radiated Emission Test Setup

A full system calibration was performed on the test station and any resulting system losses (or gains) were taken into account in the production of all final measurement data.

This test report may be reproduced in full only. The document may only be updated by MiCOM Labs personnel. Any changes will be noted in the Document History section of the report.



Title: NetScout Systems Inc. SENSOR4 Product Family
To: FCC CFR 47 Part 15 Subpart E 15.407 & IC RSS-247
Serial #: NTCT77-U4 Rev B
Issue Date: 12th December 2016
Page: 25 of 128

Asset#	Description	Manufacturer	Model#	Serial#	Calibration Due Date
158	Barometer/Thermometer	Control Company	4196	E2846	30 Nov 2017
170	Video System Controller for Semi Anechoic Chamber	Panasonic	WV-CU101	04R08507	Not Required
287	Rohde & Schwarz 40 GHz Receiver	Rhode & Schwarz	ESIB40	100201	02 May 2017
301	5470 to 5725 MHz Notch Filter	Microtronics	RBC50704	001	16 Aug 2017
302	5150 to 5350 MHz Notch Filter	Microtronics	BRC50703	002	16 Aug 2017
303	5725 to 5875 MHz Notch filter	Microtronics	BRC50705	003	16 Aug 2017
330	Variac 0-280 Vac	Staco Energy Co	3PN1020B	0546	Cal when used
336	Active loop Ant 10kHz to 30 MHz	EMCO	EMCO 6502	00060498	26 Sep 2017
338	Sunol 30 to 3000 MHz Antenna	Sunol	JB3	A052907	15 Aug 2017
373	26III RMS Multimeter	Fluke	Fluke 26 series III	76080720	26 Oct 2017
377	Band Rejection Filter 5150 to 5880MHz	Microtronics	BRM50716	034	16 Aug 2017
378	Rohde & Schwarz 40 GHz Receiver with Generator	Rhode & Schwarz	ESIB40	100107/040	04 Aug 2017
393	DC - 1050 MHz Low Pass Filter	Microcircuits	VLFX-1050	N/A	16 Aug 2017
396	2.4 GHz Notch Filter	Microtronics	BRM50701	001	16 Aug 2017
397	Amp 10 - 2500MHz	MiCOM Labs	Amp 10 - 2500 MHz	NA	09 Jun 2017
399	ETS 1-18 GHz Horn Antenna	ETS	3117	00154575	10 Jan 2017
406	Amplifier for Radiated Emissions	MiCOM Labs	40dB 1 to 18GHz Amp	0406	09 Jun 2017
410	Desktop Computer	Dell	Inspiron 620	WS38	Not Required
411	Mast/Turntable Controller	Sunol Sciences	SC98V	060199-1D	Not Required
412	USB to GPIB Interface	National Instruments	GPIB-USB HS	11B8DC2	Not Required
413	Mast Controller	Sunol Science	TWR95-4	030801-3	Not Required
414	DC Power Supply 0-60V	HP	6274	1029A01285	Cal when used
415	Turntable Controller	Sunol Sciences	Turntable Controller	None	Not Required
416	Gigabit ethernet filter	ETS-Lingren	Gigafoil 260366	None	Not Required

This test report may be reproduced in full only. The document may only be updated by MiCOM Labs personnel. Any changes will be noted in the Document History section of the report.



Title: NetScout Systems Inc. SENSOR4 Product Family
To: FCC CFR 47 Part 15 Subpart E 15.407 & IC RSS-247
Serial #: NTCT77-U4 Rev B
Issue Date: 12th December 2016
Page: 26 of 128

447	Rad Emissions Test Software	MiCOM	Rad Emissions Test Software Version 1.0.109	447	Not Required
462	Schwarzbeck cable from Antenna to Amplifier.	Schwarzbeck	AK 9513	462	31 May 2017
463	Schwarzbeck cable from Amplifier to Bulkhead.	Schwarzbeck	AK 9513	463	31 May 2017
464	Schwarzbeck cable from Bulkhead to Receiver	Schwarzbeck	AK 9513	464	31 May 2017
465	Low Pass Filter DC-1000 MHz	Mini-Circuits	NLP-1200+	VUU01901402	02 Jun 2017
466	Low Pass Filter DC-1500 MHz	Mini-Circuits	NLP-1750+	VUU10401438	02 Jun 2017
467	2495 to 2650 MHz notch filter	MicroTronics	BRM50709	011	16 Aug 2017
468	Low pass filter	Mini Circuits	SLP-550	None	16 Aug 2017
469	Low pass filter	Mini Circuit	SLP-1000	None	16 Aug 2017
470	High Pass filter	Mini Circuits	SHP-700	None	16 Aug 2017
476	Low Pass dc-2200MHz filter	Mini Circuits	15542 NLP-2400+	VUU13801345	16 Aug 2017
480	Cable - Bulkhead to Amp	SRC Haverhill	157-157-3050360	480	02 Jun 2017
481	Cable - Bulkhead to Receiver	SRC Haverhill	151-151-3050787	481	02 Jun 2017
482	Cable - Amp to Antenna	SRC Haverhill	157-157-3051574	482	02 Jun 2017
502	Test Software for Radiated Emissions	EMISoft	Vasona	Version 5 Build 59	Not Required
87	Uninterruptible Power Supply	Falcon Electric	ED2000-1/2LC	F3471 02/01	Cal when used
VLF-1700	Low pass filter DC-1700 MHz	Mini Circuits	VLF-1700	None	31 May 2017

This test report may be reproduced in full only. The document may only be updated by MiCOM Labs personnel. Any changes will be noted in the Document History section of the report.

7.2. Conducted

Conducted RF Emission Test Set-up(s)

The following tests were performed using the conducted test set-up shown in the diagram below.

1. PEAK TRANSMIT POWER
2. 6 dB & 99% BANDWIDTH
3. POWER SPECTRAL DENSITY

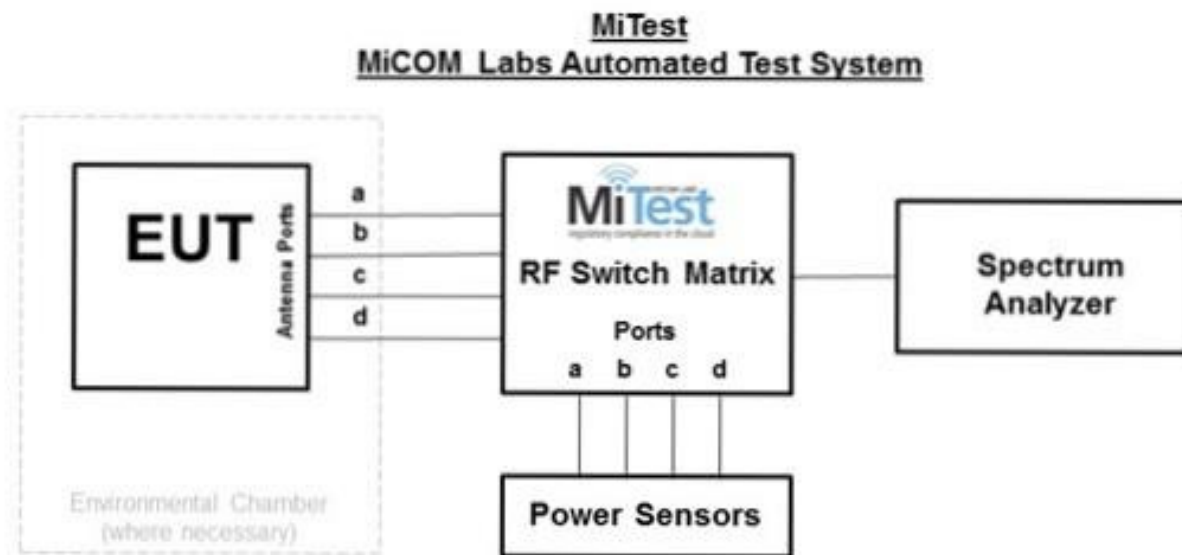

A full system calibration was performed on the test station and any resulting system losses (or gains) were taken into account in the production of all final measurement data.

Asset#	Description	Manufacturer	Model#	Serial#	Calibration Due Date
127	Power Supply	HP	6674A	US36370530	Cal when used
158	Barometer/Thermometer	Control Company	4196	E2846	30 Nov 2017
248	Resistance Thermometer	Thermotronics	GR2105-02	9340 #1	21 Oct 2017
287	Rohde & Schwarz 40 GHz Receiver	Rhode & Schwarz	ESIB40	100201	02 May 2017
376	USB 10MHz - 18GHz Average Power Sensor	Agilent	U2000A	MY51440005	23 Oct 2017
378	Rohde & Schwarz 40	Rhode &	ESIB40	100107/040	04 Aug 2017

This test report may be reproduced in full only. The document may only be updated by MiCOM Labs personnel. Any changes will be noted in the Document History section of the report.



Title: NetScout Systems Inc. SENSOR4 Product Family
To: FCC CFR 47 Part 15 Subpart E 15.407 & IC RSS-247
Serial #: NTCT77-U4 Rev B
Issue Date: 12th December 2016
Page: 28 of 128

	GHz Receiver with Generator	Schwarz			
381	4x4 RF Switch Box	MiCOM Labs	MiTest RF Switch Box	MIC002	18 Dec 2016
398	Test Software	MiCOM	MiTest ATS	Version 4.1.0.76	Not Required
419	Laptop with Labview Software	Lenova	W520	TS02	Not Required
420	USB to GPIB Interface	National Instruments	GPIB-USB HS	1346738	Not Required
440	USB Wideband Power Sensor	Boonton	55006	9178	25 Dec 2016
442	USB Wideband Power Sensor	Boonton	55006	9181	06 Oct 2017
445	PoE Injector	D-Link	DPE-101GL	QTAH1E2000625	Not Required
460	Dell Computer with installation of MiTest executable.	Dell	Optiplex330	BC944G1	Not Required
461	Spectrum Analyzer	Agilent	E4440A	MY46185537	13 Aug 2017
493	USB Wideband Power Sensor	Boonton	55006	9634	10 Mar 2017
494	USB Wideband Power Sensor	Boonton	55006	9726	10 Mar 2017
74	Environmental Chamber Chamber 3	Tenney	TTC	12808-1	29 Sep 2017
RF#2 GPIB#1	GPIB cable to Power Supply	HP	GPIB	None	Not Required
RF#2 SMA#1	EUT to Mitest box port 1	Flexco	SMA Cable port1	None	18 Dec 2016
RF#2 SMA#2	EUT to Mitest box port 2	Flexco	SMA Cable port2	None	18 Dec 2016
RF#2 SMA#3	EUT to Mitest box port 3	Flexco	SMA Cable port3	None	18 Dec 2016
RF#2 SMA#4	EUT to Mitest box port 4	Flexco	SMA Cable port4	None	18 Dec 2016
RF#2 SMA#SA	Mitest box to SA	Flexco	SMA Cable SA	None	18 Dec 2016
RF#2 USB#1	USB Cable to Mitest Box	Dynex	USB Cable	None	Not Required

This test report may be reproduced in full only. The document may only be updated by MiCOM Labs personnel. Any changes will be noted in the Document History section of the report.



8. MEASUREMENT AND PRESENTATION OF TEST DATA

The measurement and graphical data presented in this test report was generated automatically using state-of-the-art technology creating an easy to read report structure. Numerical measurement data is separated from supporting graphical data (plots) through hyperlinks. Numerical measurement data can be reviewed without scrolling through numerous graphical pages to arrive at the next data matrix.

Plots have been relegated into the Appendix 'Graphical Data'.

Test and report automation was performed by [MiTest](#). [MiTest](#) is an automated test system developed by MiCOM Labs. [MiTest](#) is the first cloud based modular test system enabling end-to-end automation of regulatory compliance testing for conducted RF testing.



The MiCOM Labs "[MiTest](#)" Automated Test System" (Patent Pending)

This test report may be reproduced in full only. The document may only be updated by MiCOM Labs personnel. Any changes will be noted in the Document History section of the report.



9. TEST RESULTS

9.1. Peak Transmit Power

Conducted Test Conditions for Maximum Conducted Output Power			
Standard:	FCC CFR 47:15.407	Ambient Temp. (°C):	24.0 - 27.5
Test Heading:	Maximum Conducted Output Power	Rel. Humidity (%):	32 - 45
Standard Section(s):	15.407 (a)	Pressure (mBars):	999 - 1001
Reference Document(s):	See Normative References		

Test Procedure for Maximum Conducted Output Power Measurement

Method PM (Measurement using an RF average power meter). KDB 789033 defines a methodology using an average wideband power meter. Measurements were made while the EUT was operating in a continuous transmission mode (100% duty cycle) at the appropriate center frequency. All operational modes and frequency bands were measured independently and the resultant calculated. Where the device operated with multiple antenna ports i.e. MIMO device, each port was measured and reported separately. A summation (Σ) of each antenna port output power is provided which includes any offset due to Duty Cycle Correction Factor (DCCF). Testing was performed under ambient conditions at nominal voltage.

Test configuration and setup used for the measurement was per the Conducted Test Set-up section specified in this document.

Supporting Information

Calculated Power = $A + G + Y + 10 \log(1/x)$ dBm

A = Total Power [$10 \cdot \log_{10}(10^{a/10} + 10^{b/10} + 10^{c/10} + 10^{d/10})$]

G = Antenna Gain

Y = Beamforming Gain

x = Duty Cycle (average power measurements only)

Limits Maximum Conducted Output Power

Operating Frequency Band 5150-5250 MHz

15.407 (a)(1)

(i) For an outdoor access point operating in the band 5.15-5.25 GHz, the maximum conducted output power over the frequency band of operation shall not exceed 1 W provided the maximum antenna gain does not exceed 6 dBi. In addition, the maximum power spectral density shall not exceed 17 dBm in any 1 megahertz band. If transmitting antennas of directional gain greater than 6 dBi are used, both the maximum conducted output power and the maximum power spectral density shall be reduced by the amount in dB that the directional gain of the antenna exceeds 6 dBi. The maximum e.i.r.p. at any elevation angle above 30 degrees as measured from the horizon must not exceed 125 mW (21 dBm).

(ii) For an indoor access point operating in the band 5.15-5.25 GHz, the maximum conducted output power over the frequency band of operation shall not exceed 1 W provided the maximum antenna gain does not exceed 6 dBi. In addition, the maximum power spectral density shall not exceed 17 dBm in any 1 megahertz band. If transmitting antennas of directional gain greater than 6 dBi are used, both the maximum conducted output power and the maximum power spectral density shall be reduced by the amount in dB that the directional gain of the antenna exceeds 6 dBi.

(iii) For fixed point-to-point access points operating in the band 5.15-5.25 GHz, the maximum conducted output power over the frequency band of operation shall not exceed 1 W. In addition, the maximum power spectral density shall not exceed 17 dBm in any 1 megahertz band. Fixed point-to-point U-NII devices may employ antennas with directional gain up to 23 dBi without any corresponding reduction in the maximum conducted output power or maximum power spectral density. For fixed point-to-point transmitters that employ a directional antenna gain greater than 23 dBi, a 1 dB reduction in maximum conducted output power and maximum power spectral density is required for each 1 dB of antenna gain in excess of 23 dBi. Fixed, point-to-point operations exclude the use of point-to-multipoint systems, omnidirectional applications, and multiple collocated transmitters transmitting the same information. The operator of the U-NII device, or if the equipment is professionally installed, the installer, is responsible for ensuring that systems employing high gain directional antennas are used exclusively for fixed, point-to-point operations.

This test report may be reproduced in full only. The document may only be updated by MiCOM Labs personnel. Any changes will be noted in the Document History section of the report.



Title: NetScout Systems Inc. SENSOR4 Product Family
To: FCC CFR 47 Part 15 Subpart E 15.407 & IC RSS-247
Serial #: NTCT77-U4 Rev B
Issue Date: 12th December 2016
Page: 31 of 128

(iv) For mobile and portable client devices in the 5.15-5.25 GHz band, the maximum conducted output power over the frequency band of operation shall not exceed 250 mW provided the maximum antenna gain does not exceed 6 dBi. In addition, the maximum power spectral density shall not exceed 11 dBm in any 1 megahertz band. If transmitting antennas of directional gain greater than 6 dBi are used, both the maximum conducted output power and the maximum power spectral density shall be reduced by the amount in dB that the directional gain of the antenna exceeds 6 dBi.

Operating Frequency Band 5250-5350 and 5470 – 5725 MHz

15. 407 (a)(2)

For the 5.25-5.35 GHz and 5.47-5.725 GHz bands, the maximum conducted output power over the frequency bands of operation shall not exceed the lesser of 250 mW or 11 dBm + 10 log B, where B is the 26 dB emission bandwidth in megahertz. In addition, the maximum power spectral density shall not exceed 11 dBm in any 1 megahertz band. If transmitting antennas of directional gain greater than 6 dBi are used, both the maximum conducted output power and the maximum power spectral density shall be reduced by the amount in dB that the directional gain of the antenna exceeds 6 dBi.

Operating Frequency Band 5725 – 5850 MHz

15. 407 (a)(3)

For the band 5.725-5.85 GHz, the maximum conducted output power over the frequency band of operation shall not exceed 1 W. In addition, the maximum power spectral density shall not exceed 30 dBm in any 500-kHz band. If transmitting antennas of directional gain greater than 6 dBi are used, both the maximum conducted output power and the maximum power spectral density shall be reduced by the amount in dB that the directional gain of the antenna exceeds 6 dBi. However, fixed point-to-point U-NII devices operating in this band may employ transmitting antennas with directional gain greater than 6 dBi without any corresponding reduction in transmitter conducted power. Fixed, point-to-point operations exclude the use of point-to-multipoint systems, omnidirectional applications, and multiple collocated transmitters transmitting the same information. The operator of the U-NII device, or if the equipment is professionally installed, the installer, is responsible for ensuring that systems employing high gain directional antennas are used exclusively for fixed, point-to-point operations.

This test report may be reproduced in full only. The document may only be updated by MiCOM Labs personnel. Any changes will be noted in the Document History section of the report.



Title: NetScout Systems Inc. SENSOR4 Product Family
To: FCC CFR 47 Part 15 Subpart E 15.407 & IC RSS-247
Serial #: NTCT77-U4 Rev B
Issue Date: 12th December 2016
Page: 32 of 128

Equipment Configuration for Peak Transmit Power
--

Variant:	802.11a	Duty Cycle (%):	99.0
Data Rate:	6.00 MBit/s	Antenna Gain (dBi):	2.00
Modulation:	OFDM	Beam Forming Gain (Y)(dB):	Not Applicable
TPC:	Not Applicable	Tested By:	CC
Engineering Test Notes:	None		

Test Measurement Results

Test Frequency	Measured Conducted Output Power (dBm)				Calculated Total Power	Minimum 26 dB Bandwidth	Limit	Margin	EUT Power Setting
	Port(s)								
MHz	a	b	c	d	Σ Port(s) dBm	MHz	dBm	dB	
5745.0	16.81	17.96	17.93	--	22.37	--	30.00	-7.63	26.00
5785.0	16.32	17.82	17.71	--	22.11	--	30.00	-7.89	26.00
5825.0	17.55	17.38	17.36	--	22.20	--	30.00	-7.80	26.00

Traceability to Industry Recognized Test Methodologies

Work Instruction:	WI-01 MEASURING RF OUTPUT POWER
Measurement Uncertainty:	±1.33 dB

The above measurements are true pulse readings and therefore a Duty Cycling correction factor is not required.

This test report may be reproduced in full only. The document may only be updated by MiCOM Labs personnel. Any changes will be noted in the Document History section of the report.



Title: NetScout Systems Inc. SENSOR4 Product Family
To: FCC CFR 47 Part 15 Subpart E 15.407 & IC RSS-247
Serial #: NTCT77-U4 Rev B
Issue Date: 12th December 2016
Page: 33 of 128

Equipment Configuration for Peak Transmit Power

Variant:	802.11n HT-20	Duty Cycle (%):	99.0
Data Rate:	6.50 MBit/s	Antenna Gain (dBi):	2.00
Modulation:	OFDM	Beam Forming Gain (Y)(dB):	Not Applicable
TPC:	Not Applicable	Tested By:	CC
Engineering Test Notes:	None		

Test Measurement Results									
Test Frequency	Measured Conducted Output Power (dBm)				Calculated Total Power	Minimum 26 dB Bandwidth	Limit	Margin	EUT Power Setting
	Port(s)								
MHz	a	b	c	d	Σ Port(s) dBm	MHz	dBm	dB	
5745.0	16.67	17.87	17.79	--	22.25	--	30.00	-7.75	26.00
5785.0	16.15	17.60	17.49	--	21.90	--	30.00	-8.10	26.00
5825.0	15.57	17.37	17.33	--	21.60	--	30.00	-8.40	26.00

Traceability to Industry Recognized Test Methodologies	
Work Instruction:	WI-01 MEASURING RF OUTPUT POWER
Measurement Uncertainty:	±1.33 dB

The above measurements are true pulse readings and therefore a Duty Cycling correction factor is not required.

This test report may be reproduced in full only. The document may only be updated by MiCOM Labs personnel. Any changes will be noted in the Document History section of the report.



Title: NetScout Systems Inc. SENSOR4 Product Family
To: FCC CFR 47 Part 15 Subpart E 15.407 & IC RSS-247
Serial #: NTCT77-U4 Rev B
Issue Date: 12th December 2016
Page: 34 of 128

Equipment Configuration for Peak Transmit Power
--

Variant:	802.11n HT-40	Duty Cycle (%):	99.0
Data Rate:	13.50 MBit/s	Antenna Gain (dBi):	2.00
Modulation:	OFDM	Beam Forming Gain (Y)(dB):	Not Applicable
TPC:	Not Applicable	Tested By:	CC
Engineering Test Notes:	None		

Test Measurement Results

Test Frequency	Measured Conducted Output Power (dBm)				Calculated Total Power	Minimum 26 dB Bandwidth	Limit	Margin	EUT Power Setting
	Port(s)								
MHz	a	b	c	d	Σ Port(s) dBm	MHz	dBm	dB	
5755.0	16.11	17.23	17.22	--	21.66	--	30.00	-8.34	25.00
5795.0	15.43	16.95	16.89	--	21.25	--	30.00	-8.75	25.00

Traceability to Industry Recognized Test Methodologies

Work Instruction:	WI-01 MEASURING RF OUTPUT POWER
Measurement Uncertainty:	±1.33 dB

The above measurements are true pulse readings and therefore a Duty Cycling correction factor is not required.

This test report may be reproduced in full only. The document may only be updated by MiCOM Labs personnel. Any changes will be noted in the Document History section of the report.



Title: NetScout Systems Inc. SENSOR4 Product Family
To: FCC CFR 47 Part 15 Subpart E 15.407 & IC RSS-247
Serial #: NTCT77-U4 Rev B
Issue Date: 12th December 2016
Page: 35 of 128

9.2. 6 dB & 99% Bandwidth

Conducted Test Conditions for 6 dB and 99% Bandwidth			
Standard:	FCC CFR 47:15.407	Ambient Temp. (°C):	24.0 - 27.5
Test Heading:	6 dB and 99 % Bandwidth	Rel. Humidity (%):	32 - 45
Standard Section(s):	15.407 (a)	Pressure (mBars):	999 - 1001
Reference Document(s):	See Normative References		
Test Procedure for 6 dB and 99% Bandwidth Measurement The bandwidth at 6 dB and 99 % is measured with a spectrum analyzer connected to the antenna terminal, while EUT is operating in transmission mode at the appropriate center frequency. The Resolution Bandwidth was set to 100 kHz. Testing was performed under ambient conditions at nominal voltage. Where the device operated with multiple antenna ports i.e. MIMO device, each port was measured and reported. Test configuration and setup used for the measurement was per the Conducted Test Set-up section specified in this document.			

This test report may be reproduced in full only. The document may only be updated by MiCOM Labs personnel. Any changes will be noted in the Document History section of the report.



Title: NetScout Systems Inc. SENSOR4 Product Family
To: FCC CFR 47 Part 15 Subpart E 15.407 & IC RSS-247
Serial #: NTCT77-U4 Rev B
Issue Date: 12th December 2016
Page: 36 of 128

Equipment Configuration for 6 dB & 99% Bandwidth

Variant:	802.11a	Duty Cycle (%):	99.0
Data Rate:	6.00 MBit/s	Antenna Gain (dBi):	2.00
Modulation:	OFDM	Beam Forming Gain (Y)(dB):	Not Applicable
TPC:	Not Applicable	Tested By:	CC
Engineering Test Notes:	None		

Test Measurement Results

Test Frequency	Measured 6 dB Bandwidth (MHz)				6 dB Bandwidth (MHz)			
	Port(s)				Highest	Lowest		
MHz	a	b	c	d				
5745.0	16.112	16.353	16.353	--	16.353	16.112		
5785.0	16.433	16.353	16.353	--	16.433	16.353		
5825.0	16.353	16.353	16.353	--	16.353	16.353		

Test Frequency	Measured 99% Bandwidth (MHz)				99% Bandwidth (MHz)			
	Port(s)				Highest	Lowest		
MHz	a	b	c	d				
5745.0	32.064	32.064	33.988	--	33.988	32.064		
5785.0	31.904	31.423	33.347	--	33.347	31.423		
5825.0	26.934	28.697	31.824	--	31.824	26.934		

Traceability to Industry Recognized Test Methodologies

Work Instruction:	WI-03 MEASURING RF SPECTRUM MASK
Measurement Uncertainty:	2.81 dB

Note: click the links in the above matrix to view the graphical image (plot).

This test report may be reproduced in full only. The document may only be updated by MiCOM Labs personnel. Any changes will be noted in the Document History section of the report.



Title: NetScout Systems Inc. SENSOR4 Product Family
To: FCC CFR 47 Part 15 Subpart E 15.407 & IC RSS-247
Serial #: NTCT77-U4 Rev B
Issue Date: 12th December 2016
Page: 37 of 128

Equipment Configuration for 6 dB & 99% Bandwidth

Variant:	802.11n HT-20	Duty Cycle (%):	99.0
Data Rate:	6.50 MBit/s	Antenna Gain (dBi):	2.00
Modulation:	OFDM	Beam Forming Gain (Y)(dB):	Not Applicable
TPC:	Not Applicable	Tested By:	CC
Engineering Test Notes:	None		

Test Measurement Results

Test Frequency	Measured 6 dB Bandwidth (MHz)				6 dB Bandwidth (MHz)			
	Port(s)				Highest	Lowest		
MHz	a	b	c	d				
5745.0	17.555	17.315	17.555	--	17.555	17.315		
5785.0	17.234	17.555	17.555	--	17.555	17.234		
5825.0	17.555	17.315	17.555	--	17.555	17.315		

Test Frequency	Measured 99% Bandwidth (MHz)				99% Bandwidth (MHz)			
	Port(s)				Highest	Lowest		
MHz	a	b	c	d				
5745.0	33.427	32.625	34.389	--	34.389	32.625		
5785.0	30.621	31.182	33.347	--	33.347	30.621		
5825.0	28.216	29.900	32.545	--	32.545	28.216		

Traceability to Industry Recognized Test Methodologies

Work Instruction:	WI-03 MEASURING RF SPECTRUM MASK
Measurement Uncertainty:	±2.81 dB

Note: click the links in the above matrix to view the graphical image (plot).

This test report may be reproduced in full only. The document may only be updated by MiCOM Labs personnel. Any changes will be noted in the Document History section of the report.



Title: NetScout Systems Inc. SENSOR4 Product Family
To: FCC CFR 47 Part 15 Subpart E 15.407 & IC RSS-247
Serial #: NTCT77-U4 Rev B
Issue Date: 12th December 2016
Page: 38 of 128

Equipment Configuration for 6 dB & 99% Bandwidth

Variant:	802.11n HT-40	Duty Cycle (%):	99.0
Data Rate:	13.50 MBit/s	Antenna Gain (dBi):	2.00
Modulation:	OFDM	Beam Forming Gain (Y)(dB):	Not Applicable
TPC:	Not Applicable	Tested By:	CC
Engineering Test Notes:	None		

Test Measurement Results

Test Frequency	Measured 6 dB Bandwidth (MHz)				6 dB Bandwidth (MHz)			
	Port(s)				Highest	Lowest		
MHz	a	b	c	d				
5755.0	35.912	36.393	36.072	--	36.393	35.912		
5795.0	36.393	36.393	36.393	--	36.393	36.393		

Test Frequency	Measured 99% Bandwidth (MHz)				99% Bandwidth (MHz)			
	Port(s)				Highest	Lowest		
MHz	a	b	c	d				
5755.0	66.693	67.495	69.419	--	69.419	66.693		
5795.0	60.281	65.090	68.136	--	68.136	60.281		

Traceability to Industry Recognized Test Methodologies

Work Instruction:	WI-03 MEASURING RF SPECTRUM MASK
Measurement Uncertainty:	±2.81 dB

Note: click the links in the above matrix to view the graphical image (plot).

This test report may be reproduced in full only. The document may only be updated by MiCOM Labs personnel. Any changes will be noted in the Document History section of the report.



9.3. Power Spectral Density

Conducted Test Conditions for Power Spectral Density			
Standard:	FCC CFR 47:15.407	Ambient Temp. (°C):	24.0 - 27.5
Test Heading:	Power Spectral Density	Rel. Humidity (%):	32 - 45
Standard Section(s):	15.407 (a)	Pressure (mBars):	999 - 1001
Reference Document(s):	See Normative References		

Test Procedure for Power Spectral Density

The in-band power spectral density was measured using the test technique specified in KDB 789033. A 1 MHz measurement bandwidth was implemented for the analyzer sweep. Once the sweep is complete the analyzer trace data is downloaded and used for post processing purposes.

Where the device operated with multiple antenna ports i.e. MIMO device, each port was measured separately. The Peak Power Spectral Density is the highest level found across the emission bandwidth. With multiple antenna port measurements the numerical analyzer data from each port is summed (\hat{a}) and a link to this additional graphic is provided.

Test configuration and setup used for the measurement was per the Conducted Test Set-up section specified in this document.

Measure and sum the spectra across the outputs. With this technique, spectra are measured at each output of the device at the required resolution bandwidth. The individual spectra are then summed mathematically in linear power units. Unlike in-band power measurements, in which the sum involves a single measured value (output power) from each output, measurements for compliance with PSD limits involve summing entire spectra across corresponding frequency bins on the various outputs. Consistency is maintained for any device with multiple transmitter outputs to be certain the individual outputs are all aligned with the same span and same number of points. In this instance, the linear power spectrum value within the first spectral bin of output 0 is summed with that in the first spectral bin of output 1, and the first spectral bin of output 2, and so on up to the Nth output to obtain the true value for the first frequency bin of the summed spectrum. The summed spectrum value for each frequency bin is computed in this fashion. These summed spectral values were post processed and the resulting numerical and graphical data presented.

NOTE: It may be observed that spectrum in some plots break the limit line however this in itself does NOT constitute a failure. In all cases a spectrum summation plot is provided in order to prove compliance. A failure occurs only after the summation of all spectrum plots have been summed and are found to be greater than the limit line.

Supporting Information

Calculated Power = $A + 10 \log(1/x)$ dBm

$A = \text{Total Power Spectral Density} [10^{\log_{10}}(10^{a/10} + 10^{b/10} + 10^{c/10} + 10^{d/10})]$

$x = \text{Duty Cycle}$

Limits Power Spectral Density

Operating Frequency Band 5150-5250 MHz

15.407 (a)(1)

(i) For an outdoor access point operating in the band 5.15-5.25 GHz, the maximum conducted output power over the frequency band of operation shall not exceed 1 W provided the maximum antenna gain does not exceed 6 dBi. In addition, the maximum power spectral density shall not exceed 17 dBm in any 1 megahertz band. If transmitting antennas of directional gain greater than 6 dBi are used, both the maximum conducted output power and the maximum power spectral density shall be reduced by the amount in dB that the directional gain of the antenna exceeds 6 dBi. The maximum e.i.r.p. at any elevation angle above 30 degrees as measured from the horizon must not exceed 125 mW (21 dBm).

(ii) For an indoor access point operating in the band 5.15-5.25 GHz, the maximum conducted output power over the frequency band of operation shall not exceed 1 W provided the maximum antenna gain does not exceed 6 dBi. In addition, the maximum power spectral density shall not exceed 17 dBm in any 1 megahertz band. If transmitting antennas of directional gain greater than 6 dBi are used, both the maximum conducted output power and the maximum power spectral density shall be reduced by the amount in dB that the directional gain of the antenna exceeds 6 dBi.

(iii) For fixed point-to-point access points operating in the band 5.15-5.25 GHz, the maximum conducted output power over the

This test report may be reproduced in full only. The document may only be updated by MiCOM Labs personnel. Any changes will be noted in the Document History section of the report.



Title: NetScout Systems Inc. SENSOR4 Product Family
To: FCC CFR 47 Part 15 Subpart E 15.407 & IC RSS-247
Serial #: NTCT77-U4 Rev B
Issue Date: 12th December 2016
Page: 40 of 128

frequency band of operation shall not exceed 1 W. In addition, the maximum power spectral density shall not exceed 17 dBm in any 1 megahertz band. Fixed point-to-point U-NII devices may employ antennas with directional gain up to 23 dBi without any corresponding reduction in the maximum conducted output power or maximum power spectral density. For fixed point-to-point transmitters that employ a directional antenna gain greater than 23 dBi, a 1 dB reduction in maximum conducted output power and maximum power spectral density is required for each 1 dB of antenna gain in excess of 23 dBi. Fixed, point-to-point operations exclude the use of point-to-multipoint systems, omnidirectional applications, and multiple collocated transmitters transmitting the same information. The operator of the U-NII device, or if the equipment is professionally installed, the installer, is responsible for ensuring that systems employing high gain directional antennas are used exclusively for fixed, point-to-point operations.

(iv) For mobile and portable client devices in the 5.15-5.25 GHz band, the maximum conducted output power over the frequency band of operation shall not exceed 250 mW provided the maximum antenna gain does not exceed 6 dBi. In addition, the maximum power spectral density shall not exceed 11 dBm in any 1 megahertz band. If transmitting antennas of directional gain greater than 6 dBi are used, both the maximum conducted output power and the maximum power spectral density shall be reduced by the amount in dB that the directional gain of the antenna exceeds 6 dBi.

Operating Frequency Band 5250-5350 and 5470 – 5725 MHz

15. 407 (a)(2)

For the 5.25-5.35 GHz and 5.47-5.725 GHz bands, the maximum conducted output power over the frequency bands of operation shall not exceed the lesser of 250 mW or 11 dBm + 10 log B, where B is the 26 dB emission bandwidth in megahertz. In addition, the maximum power spectral density shall not exceed 11 dBm in any 1 megahertz band. If transmitting antennas of directional gain greater than 6 dBi are used, both the maximum conducted output power and the maximum power spectral density shall be reduced by the amount in dB that the directional gain of the antenna exceeds 6 dBi.

Operating Frequency Band 5725 – 5850 MHz

15. 407 (a)(3)

For the band 5.725-5.85 GHz, the maximum conducted output power over the frequency band of operation shall not exceed 1 W. In addition, the maximum power spectral density shall not exceed 30 dBm in any 500-kHz band. If transmitting antennas of directional gain greater than 6 dBi are used, both the maximum conducted output power and the maximum power spectral density shall be reduced by the amount in dB that the directional gain of the antenna exceeds 6 dBi. However, fixed point-to-point U-NII devices operating in this band may employ transmitting antennas with directional gain greater than 6 dBi without any corresponding reduction in transmitter conducted power. Fixed, point-to-point operations exclude the use of point-to-multipoint systems, omnidirectional applications, and multiple collocated transmitters transmitting the same information. The operator of the U-NII device, or if the equipment is professionally installed, the installer, is responsible for ensuring that systems employing high gain directional antennas are used exclusively for fixed, point-to-point operations.

This test report may be reproduced in full only. The document may only be updated by MiCOM Labs personnel. Any changes will be noted in the Document History section of the report.



Title: NetScout Systems Inc. SENSOR4 Product Family
To: FCC CFR 47 Part 15 Subpart E 15.407 & IC RSS-247
Serial #: NTCT77-U4 Rev B
Issue Date: 12th December 2016
Page: 41 of 128

Equipment Configuration for Power Spectral Density

Variant:	802.11a	Duty Cycle (%):	99.0
Data Rate:	6.00 MBit/s	Antenna Gain (dBi):	2.00
Modulation:	OFDM	Beam Forming Gain (Y)(dB):	Not Applicable
TPC:	Not Applicable	Tested By:	CC
Engineering Test Notes:	None		

Test Measurement Results

Test Frequency	Measured Power Spectral Density				Summation Peak Marker + DCCF (+0.04 dB)	Limit	Margin
	Port(s) (dBm/500 KHz)						
MHz	a	b	c	d	dBm/500 KHz	dBm/500 KHz	dB
5745.0	4.842	2.846	3.138	--	8.471	30.0	-21.5
5785.0	4.452	2.846	3.029	--	8.087	30.0	-21.9
5825.0	3.899	2.528	2.903	--	7.771	30.0	-22.2

Traceability to Industry Recognized Test Methodologies

Work Instruction:	WI-03 MEASURING RF SPECTRUM MASK
Measurement Uncertainty:	±2.81 dB

DCCF - Duty Cycle Correction Factor

Note: click the links in the above matrix to view the graphical image (plot).

This test report may be reproduced in full only. The document may only be updated by MiCOM Labs personnel. Any changes will be noted in the Document History section of the report.



Title: NetScout Systems Inc. SENSOR4 Product Family
To: FCC CFR 47 Part 15 Subpart E 15.407 & IC RSS-247
Serial #: NTCT77-U4 Rev B
Issue Date: 12th December 2016
Page: 42 of 128

Equipment Configuration for Power Spectral Density

Variant:	802.11n HT-20	Duty Cycle (%):	99.0
Data Rate:	6.50 MBit/s	Antenna Gain (dBi):	2.00
Modulation:	OFDM	Beam Forming Gain (Y)(dB):	Not Applicable
TPC:	Not Applicable	Tested By:	CC
Engineering Test Notes:	None		

Test Measurement Results

Test Frequency	Measured Power Spectral Density				Summation Peak Marker + DCCF (+0.04 dB)	Limit	Margin
	Port(s) (dBm/500 KHz)						
MHz	a	b	c	d	dBm/500 KHz	dBm/500 KHz	dB
5745.0	4.159	2.486	2.668	--	7.784	30.0	-22.2
5785.0	4.139	2.313	4.451	--	8.346	30.0	-21.6
5825.0	3.834	2.355	2.646	--	7.762	30.0	-22.2

Traceability to Industry Recognized Test Methodologies

Work Instruction:	WI-03 MEASURING RF SPECTRUM MASK
Measurement Uncertainty:	2.81 dB

DCCF - Duty Cycle Correction Factor

Note: click the links in the above matrix to view the graphical image (plot).

This test report may be reproduced in full only. The document may only be updated by MiCOM Labs personnel. Any changes will be noted in the Document History section of the report.



Title: NetScout Systems Inc. SENSOR4 Product Family
To: FCC CFR 47 Part 15 Subpart E 15.407 & IC RSS-247
Serial #: NTCT77-U4 Rev B
Issue Date: 12th December 2016
Page: 43 of 128

Equipment Configuration for Power Spectral Density

Variant:	802.11n HT-40	Duty Cycle (%):	99.0
Data Rate:	13.50 MBit/s	Antenna Gain (dBi):	2.00
Modulation:	OFDM	Beam Forming Gain (Y)(dB):	Not Applicable
TPC:	Not Applicable	Tested By:	CC
Engineering Test Notes:	None		

Test Measurement Results

Test Frequency	Measured Power Spectral Density				Summation Peak Marker + DCCF (+0.04 dB)	Limit	Margin
	Port(s) (dBm/500 KHz)						
MHz	a	b	c	d	dBm/500 KHz	dBm/500 KHz	dB
5755.0	1.771	-0.596	-0.225	--	5.083	30.0	-24.9
5795.0	0.769	-0.605	-0.251	--	4.547	30.0	-25.4

Traceability to Industry Recognized Test Methodologies

Work Instruction:	WI-03 MEASURING RF SPECTRUM MASK
Measurement Uncertainty:	±2.81 dB

DCCF - Duty Cycle Correction Factor

Note: click the links in the above matrix to view the graphical image (plot).

This test report may be reproduced in full only. The document may only be updated by MiCOM Labs personnel. Any changes will be noted in the Document History section of the report.



9.4. Radiated

Radiated Test Conditions for Radiated Spurious and Band-Edge Emissions			
Standard:	FCC CFR 47:15.407	Ambient Temp. (°C):	20.0 - 24.5
Test Heading:	Radiated Spurious and Band-Edge Emissions	Rel. Humidity (%):	32 - 45
Standard Section(s):	15.407 (b), 15.205, 15.209	Pressure (mBars):	999 - 1001
Reference Document(s):	See Normative References		
FCC, Part §15.407(b)(2), §15.205(a)/15.209(a) Industry Canada RSS-247; RSS-Gen §8.10			
<p>Test Procedure for Radiated Spurious and Band-Edge Emissions Radiated emissions for restricted bands above 1 GHz are measured in the anechoic chamber at a 3-meter distance on every azimuth in both horizontal and vertical polarities. The emissions are recorded and maximized as a function of azimuth by rotation through 360° with a spectrum analyzer in peak hold mode. Depending on the frequency band spanned a notch filter and waveguide filter was used to remove the fundamental frequency. The highest emissions relative to the limit are listed for each frequency spanned. Measurements on any restricted band frequency or frequencies above 1 GHz are based on the use of measurement instrumentation employing peak and average detectors. All measurements were performed using a resolution bandwidth of 1 MHz.</p> <p>Test configuration and setup for Undesirable Measurement were per the Radiated Test Set-up specified in this document. 15.407 (b) Undesirable emission limits. Except as shown in paragraph (b)(7) of this section, the maximum emissions outside of the frequency bands of operation shall be attenuated in accordance with the following limits:</p> <p>(1) For transmitters operating in the 5.15-5.25 GHz band: All emissions outside of the 5.15-5.35 GHz band shall not exceed an e.i.r.p. of -27 dBm/MHz.</p> <p>(2) For transmitters operating in the 5.25-5.35 GHz band: All emissions outside of the 5.15-5.35 GHz band shall not exceed an e.i.r.p. of -27 dBm/MHz.</p> <p>(3) For transmitters operating in the 5.47-5.725 GHz band: All emissions outside of the 5.47-5.725 GHz band shall not exceed an e.i.r.p. of -27 dBm/MHz.</p> <p>(4) For transmitters operating in the 5.725-5.85 GHz band: All emissions within the frequency range from the band edge to 10 MHz above or below the band edge shall not exceed an e.i.r.p. of -17 dBm/MHz; for frequencies 10 MHz or greater above or below the band edge, emissions shall not exceed an e.i.r.p. of -27 dBm/MHz.</p> <p>(5) The emission measurements shall be performed using a minimum resolution bandwidth of 1 MHz. A lower resolution bandwidth may be employed near the band edge, when necessary, provided the measured energy is integrated to show the total power over 1 MHz.</p> <p>(6) Unwanted emissions below 1 GHz must comply with the general field strength limits set forth in §15.209. Further, any U-NII devices using an AC power line are required to comply also with the conducted limits set forth in §15.207.</p> <p>(7) The provisions of §15.205 apply to intentional radiators operating under this section.</p> <p>(8) When measuring the emission limits, the nominal carrier frequency shall be adjusted as close to the upper and lower frequency band edges as the design of the equipment permits.</p> <p>Limits for Restricted Bands (15.205, 15.209) Peak emission: 74 dBuV/m Average emission: 54 dBuV/m</p> <p>Field Strength Calculation The field strength is calculated by adding the Antenna Factor and Cable Loss, and subtracting Amplifier Gain from the measured reading. All factors are included in the reported data. $FS = R + AF + CORR - FO$</p> <p>where: FS = Field Strength</p>			

This test report may be reproduced in full only. The document may only be updated by MiCOM Labs personnel. Any changes will be noted in the Document History section of the report.



R = Measured Spectrum analyzer Input Amplitude
 AF = Antenna Factor
 CORR = Correction Factor = CL – AG + NFL
 CL = Cable Loss
 AG = Amplifier Gain
 FO = Distance Falloff Factor
 NFL = Notch Filter Loss or Waveguide Loss

Example:

The following formula is used to convert the equipment isotropic radiated power (eirp) to field strength (dBμV/m);

$$E = \frac{1000000 \times \sqrt{30P}}{3} \mu\text{V/m}$$

where P is the EIRP in Watts

Therefore: -27 dBm/MHz equates to 68.23 dBuV/m

Conversion between dBmV/m (or dBmV) and mV/m (or mV) are as follows:

$$\text{Level (dBmV/m)} = 20 * \text{Log (level (mV/m))}$$

40 dBmV/m = 100 mV/m

48 dBmV/m = 250 mV/m

Restricted Bands of Operation (15.205)

(a) Except as shown in paragraph (d) of this section, only spurious emissions are permitted in any of the frequency bands listed below:

Frequency Band			
MHz	MHz	MHz	GHz
0.090-0.110	16.42-16.423	399.9-410	4.5-5.15
0.495-0.505	16.69475-16.69525	608-614	5.35-5.46
2.1735-2.1905	16.80425-16.80475	960-1240	7.25-7.75
4.125-4.128	25.5-25.67	1300-1427	8.025-8.5
4.17725-4.17775	37.5-38.25	1435-1626.5	9.0-9.2
4.20725-4.20775	73-74.6	1645.5-1646.5	9.3-9.5
6.215-6.218	74.8-75.2	1660-1710	10.6-12.7
6.26775-6.26825	108-121.94	1718.8-1722.2	13.25-13.4
6.31175-6.31225	123-138	2200-2300	14.47-14.5
8.291-8.294	149.9-150.05	2310-2390	15.35-16.2
8.362-8.366	156.52475-156.52525	2483.5-2500	17.7-21.4
8.37625-8.38675	156.7-156.9	2690-2900	22.01-23.12
8.41425-8.41475	162.0125-167.17	3260-3267	23.6-24.0
12.29-12.293	167.72-173.2	3332-3339	31.2-31.8
12.51975-12.52025	240-285	3345.8-3358	36.43-36.5
12.57675-12.57725	322-335.4	3600-4400	Above 38.6
13.36-13.41			

(b) Except as provided in paragraphs (d) and (e) of this section, the field strength of emissions appearing within these frequency bands shall not exceed the limits shown in §15.209. At frequencies equal to or less than 1000 MHz, compliance with the limits in §15.209 shall be demonstrated using measurement instrumentation employing a CISPR quasi-peak detector. Above 1000 MHz, compliance with the emission limits in §15.209 shall be demonstrated based on the average value of the measured emissions. The provisions in §15.35 apply to these measurements.

(c) Except as provided in paragraphs (d) and (e) of this section, regardless of the field strength limits specified elsewhere in this subpart, the provisions of this section apply to emissions from any intentional radiator.

(d) The following devices are exempt from the requirements of this section:

(1) Swept frequency field disturbance sensors operating between 1.705 and 37 MHz provided their emissions only sweep through the bands listed in paragraph (a) of this section, the sweep is never stopped with the fundamental emission within the bands listed in paragraph (a) of this section, and the fundamental emission is outside of the bands listed in paragraph (a) of this section more than

This test report may be reproduced in full only. The document may only be updated by MiCOM Labs personnel. Any changes will be noted in the Document History section of the report.



Title: NetScout Systems Inc. SENSOR4 Product Family
To: FCC CFR 47 Part 15 Subpart E 15.407 & IC RSS-247
Serial #: NTCT77-U4 Rev B
Issue Date: 12th December 2016
Page: 46 of 128

99% of the time the device is actively transmitting, without compensation for duty cycle.

- (2) Transmitters used to detect buried electronic markers at 101.4 kHz which are employed by telephone companies.
- (3) Cable locating equipment operated pursuant to §15.213.
- (4) Any equipment operated under the provisions of §15.253, 15.255, and 15.256 in the frequency band 75-85 GHz, or §15.257 of this part.
- (5) Biomedical telemetry devices operating under the provisions of §15.242 of this part are not subject to the restricted band 608-614 MHz but are subject to compliance within the other restricted bands.
- (6) Transmitters operating under the provisions of subparts D or F of this part.
- (7) Devices operated pursuant to §15.225 are exempt from complying with this section for the 13.36-13.41 MHz band only.
- (8) Devices operated in the 24.075-24.175 GHz band under §15.245 are exempt from complying with the requirements of this section for the 48.15-48.35 GHz and 72.225-72.525 GHz bands only, and shall not exceed the limits specified in §15.245(b).
- (9) Devices operated in the 24.0-24.25 GHz band under §15.249 are exempt from complying with the requirements of this section for the 48.0-48.5 GHz and 72.0-72.75 GHz bands only, and shall not exceed the limits specified in §15.249(a).
- (e) Harmonic emissions appearing in the restricted bands above 17.7 GHz from field disturbance sensors operating under the provisions of §15.245 shall not exceed the limits specified in §15.245(b).

RSS-247 Radiated emissions for restricted bands above 1 GHz are measured in the anechoic chamber at a 3-meter distance on every azimuth in both horizontal and vertical polarities. The emissions are recorded and maximized as a function of azimuth by rotation through 360° with a spectrum analyzer in peak hold mode. Depending on the frequency band spanned a notch filter and waveguide filter was used to remove the fundamental frequency. The highest emissions relative to the limit are listed for each frequency spanned. Measurements on any restricted band frequency or frequencies above 1 GHz are based on the use of measurement instrumentation employing peak and average detectors. All measurements were performed using a resolution bandwidth of 1 MHz.

Test configuration and setup for Undesirable Measurement were per the Radiated Test Set-up specified in this document. Unwanted emissions outside of the frequency bands of operation shall be attenuated in accordance with the following limits:

6.2.1. (2) Frequency Band 5150-5250 MHz

For transmitters operating in the band 5150-5250 MHz, all emissions outside the band 5150-5350 MHz shall not exceed -27 dBm/MHz e.i.r.p. However, any unwanted emissions that fall into the band 5250-5350 MHz must be 26 dBc, when measured using a resolution bandwidth between 1 and 5% of the occupied bandwidth, above 5.25 GHz. Otherwise, the transmission is considered as intentional and the devices shall implement dynamic frequency selection (DFS) and transmitter power control (TPC) as per the requirements for the band 5250-5350 MHz

6.2.4 (2) Frequency Bands 5725-5850 MHz

For the band 5725-5850 MHz, emissions at frequencies from the band edges to 10 MHz above or below the band edges shall not exceed -17 dBm/MHz e.i.r.p.

For emissions at frequencies more than 10 MHz above or below the band edges, the emissions power shall not exceed -27 dBm/MHz.

Limits for Restricted Bands (15.205, 15.209)

Peak emission: 74 dBuV/m
Average emission: 54 dBuV/m
Field Strength Calculation

This test report may be reproduced in full only. The document may only be updated by MiCOM Labs personnel. Any changes will be noted in the Document History section of the report.



Title: NetScout Systems Inc. SENSOR4 Product Family
To: FCC CFR 47 Part 15 Subpart E 15.407 & IC RSS-247
Serial #: NTCT77-U4 Rev B
Issue Date: 12th December 2016
Page: 47 of 128

The field strength is calculated by adding the Antenna Factor and Cable Loss, and subtracting Amplifier Gain from the measured reading. All factors are included in the reported data.

$$FS = R + AF + CORR - FO$$

where:

FS = Field Strength

R = Measured Spectrum analyzer Input Amplitude

AF = Antenna Factor

CORR = Correction Factor = CL – AG + NFL

CL = Cable Loss

AG = Amplifier Gain

FO = Distance Falloff Factor

NFL = Notch Filter Loss or Waveguide Loss

Example:

The following formula is used to convert the equipment isotropic radiated power (eirp) to field strength (dB μ V/m);

$$E = 1000000 \times \frac{\sqrt{30P}}{3} \mu\text{V/m}$$

where P is the EIRP in Watts

Therefore: -27 dBm/MHz equates to 68.23 dB μ V/m

Conversion between dBmV/m (or dBmV) and mV/m (or mV) are as follows:

Level (dBmV/m) = 20 * Log (level (mV/m))

40 dBmV/m = 100 mV/m

48 dBmV/m = 250 mV/m

This test report may be reproduced in full only. The document may only be updated by MiCOM Labs personnel. Any changes will be noted in the Document History section of the report.



Restricted Bands of Operation

Industry Canada Restricted Frequency Bands			
MHz	MHz	MHz	GHz
0.090-0.110	12.51975-12.52025	322-335.4	7250-7750
2.1735-2.1905	12.57675-12.57725	399.9-410	8025-8500
3.020-3.026	13.36-13.41	608-614	9000-9200
4.125-4.128	16.42-16.423	960-1427	9300-9500
4.17725-4.17775	16.80425-16.80475	1435-1626.5	10600-12700
4.20725-4.20775	25.5-25.67	1645.5-1646.5	13250-13400
5.677-5.683	37.5-38.25	1660-1710	14470-14500
6.215-6.218	73-74.6	1718.8-1722.2	15350-16200
6.26775-6.26825	74.8-75.2	2200-2300	17700-21400
6.31175-6.31225	108-138	2310-2390	22.01-23.12
8.291-8.294	156.52475-156.52525	2655-2900	23.6-24.0
8.362-8.366	156.7-156.9	3260-3267	31.2-31.8
8.37625-8.38675	162.0125-167.17	3332-3339	36.43-36.5
8.41425-8.41475	167.72-173.2	4500-5150	Above 38.6
12.29-12.293	240-285	5350-5460	

The measurement method shall be described in the test report. When the applicable unwanted emissions limits are defined in relative terms, the same parameter, peak power or average power, used for the transmitter's output power measurement shall also be used for the unwanted emission measurements.

In measuring unwanted emissions, the spectrum shall be investigated from 30 MHz or the lowest radio frequency signal generated in the equipment, whichever is lower, without going below 9 kHz, up to at least the frequency given below:

(a) If the equipment operates below 10 GHz: to the tenth harmonic of the highest fundamental frequency or to 40 GHz, whichever is lower.

(b) If the equipment operates at or above 10 GHz: to the fifth harmonic of the highest fundamental frequency or to 100 GHz, whichever is lower.

Particular attention should be paid to harmonics and sub-harmonics of the carrier frequency, as well as to those frequencies removed from the carrier by multiples of the oscillator frequency. Radiation at the frequencies of multiplier stages should also be checked.

The amplitude of spurious emissions attenuated more than 20 dB below the permissible value need not be reported.

When limits are expressed in absolute terms, compliance with the emission limits below 1000 MHz shall be demonstrated using a CISPR quasi-peak detector and the related measurement bandwidth. As an alternative to CISPR quasi-peak measurement, compliance with the emission limits can be demonstrated using measuring equipment employing a peak detector function properly adjusted for factors such as pulse desensitization as required, with an equal or greater measurement bandwidth relative to the applicable CISPR quasi-peak bandwidth.

Above 1000 MHz, compliance with the emission limits shall be demonstrated using an average detector with a minimum resolution bandwidth of 1 MHz.

This test report may be reproduced in full only. The document may only be updated by MiCOM Labs personnel. Any changes will be noted in the Document History section of the report.



9.4.1. Restricted Band Emissions

Below 1GHz

Antenna:	Integral	Variant:	802.11a
Antenna Gain (dBi):	2.0	Modulation:	OFDM
Beam Forming Gain (Y):	Not Applicable	Duty Cycle (%):	99
Channel Frequency (MHz):	5200.00	Data Rate:	6 Mbit/s
Power Setting:	10	Tested By:	OC

Test Measurement Results



Variant: 802.11b, Test Freq: 5200.00 MHz, Antenna: Integral, Power Setting: 10, Duty Cycle (%): 99

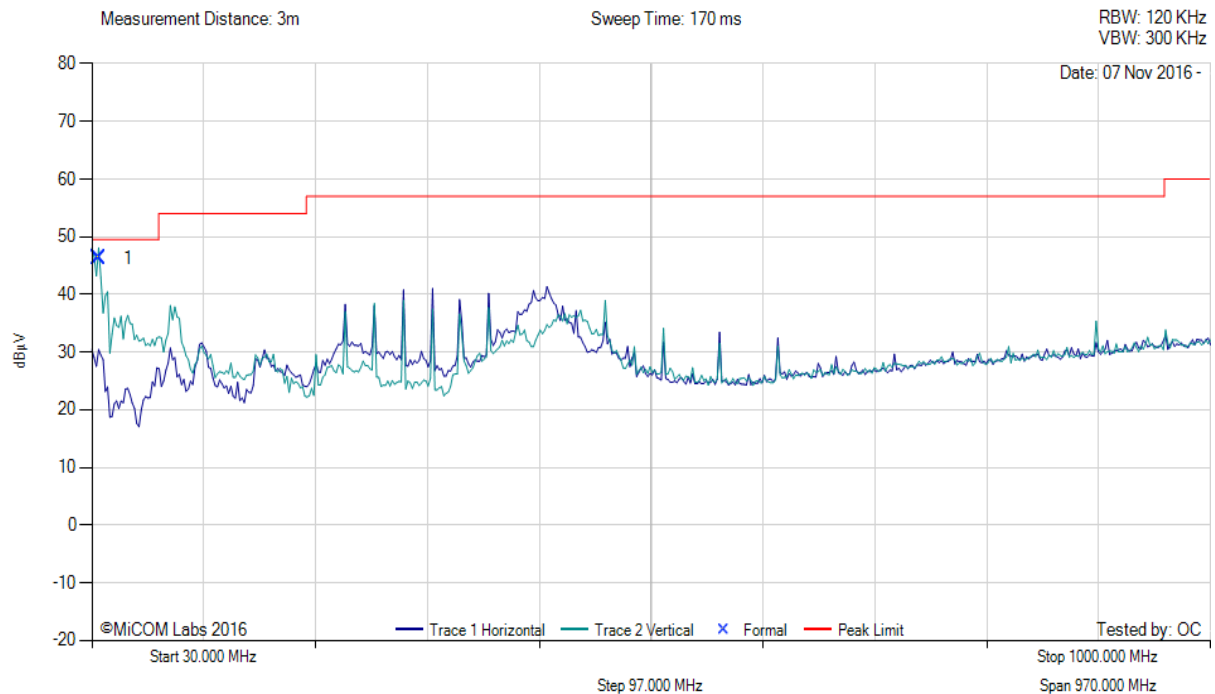

30.00 - 1000.00 MHz												
Num	Frequency MHz	Raw dBµV	Cable Loss dB	AF dB	Level dBµV/m	Measurement Type	Pol	Hgt cm	Azt Deg	Limit dBµV/m	Margin dB	Pass /Fail
1	36.21	57.21	3.47	-14.37	46.31	MaxQP	Vertical	100	217	49.5	-3.2	Pass

Test Notes: Model: SENSOR4-R2S1-I, S/N: 1517048. PoE powered and placed at 150cm non-conductive table.

This test report may be reproduced in full only. The document may only be updated by MiCOM Labs personnel. Any changes will be noted in the Document History section of the report.



Title: NetScout Systems Inc. SENSOR4 Product Family
To: FCC CFR 47 Part 15 Subpart E 15.407 & IC RSS-247
Serial #: NTCT77-U4 Rev B
Issue Date: 12th December 2016
Page: 50 of 128

Antenna:	Integral	Variant:	802.11a
Antenna Gain (dBi):	2.0	Modulation:	OFDM
Beam Forming Gain (Y):	Not Applicable	Duty Cycle (%):	99
Channel Frequency (MHz):	5300.00	Data Rate:	6 Mbit/s
Power Setting:	17	Tested By:	OC

Test Measurement Results



Variant: 802.11b, Test Freq: 5300.00 MHz, Antenna: Integral, Power Setting: 17, Duty Cycle (%): 99

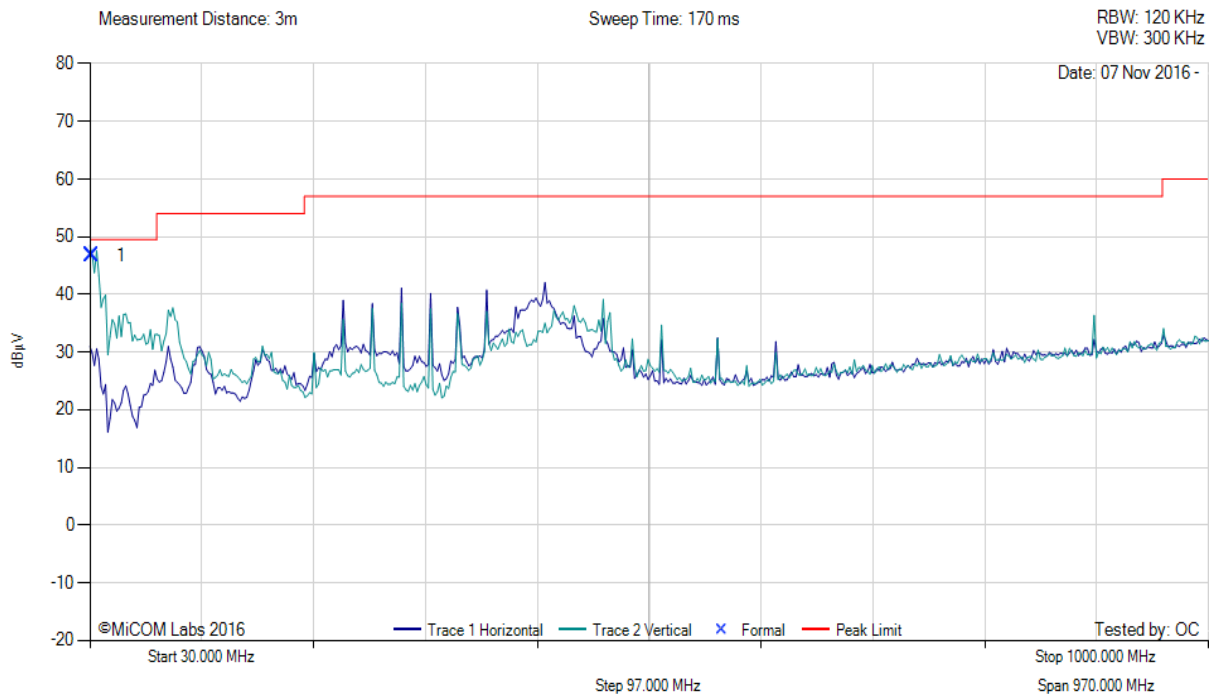

30.00 - 1000.00 MHz												
Num	Frequency MHz	Raw dBµV	Cable Loss dB	AF dB	Level dBµV/m	Measurement Type	Pol	Hgt cm	Azt Deg	Limit dBµV/m	Margin dB	Pass /Fail
1	31.84	54.54	3.44	-11.21	46.77	MaxQP	Vertical	100	139	49.5	-2.7	Pass

Test Notes: Model: SENSOR4-R2S1-I, S/N: 1517048. PoE powered and placed at 150cm non-conductive table.

This test report may be reproduced in full only. The document may only be updated by MiCOM Labs personnel. Any changes will be noted in the Document History section of the report.



Title: NetScout Systems Inc. SENSOR4 Product Family
To: FCC CFR 47 Part 15 Subpart E 15.407 & IC RSS-247
Serial #: NTCT77-U4 Rev B
Issue Date: 12th December 2016
Page: 51 of 128

Antenna:	Integral	Variant:	802.11a
Antenna Gain (dBi):	2.0	Modulation:	OFDM
Beam Forming Gain (Y):	Not Applicable	Duty Cycle (%):	99
Channel Frequency (MHz):	5580.00	Data Rate:	6 Mbit/s
Power Setting:	18	Tested By:	OC

Test Measurement Results



Variant: 802.11a, Test Freq: 5580.00 MHz, Antenna: Integral, Power Setting: 18, Duty Cycle (%): 99

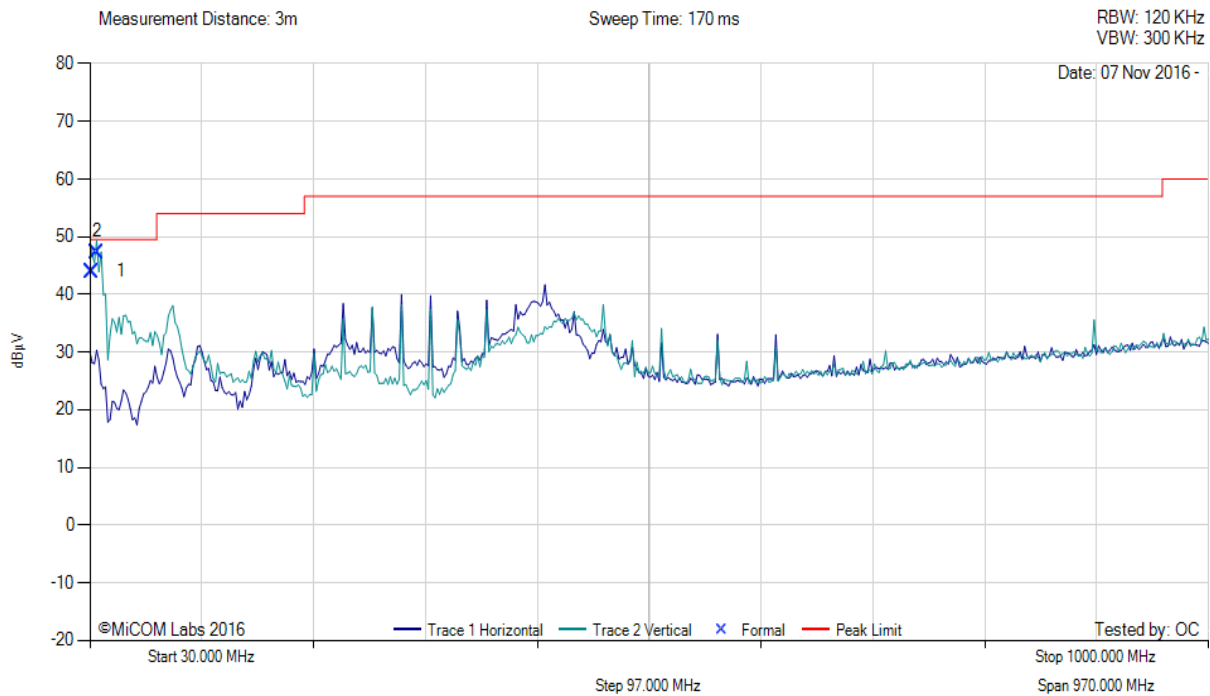

30.00 - 1000.00 MHz												
Num	Frequency MHz	Raw dBµV	Cable Loss dB	AF dB	Level dBµV/m	Measurement Type	Pol	Hgt cm	Azt Deg	Limit dBµV/m	Margin dB	Pass /Fail
1	31.81	51.81	3.44	-11.21	44.04	MaxQP	Vertical	100	212	49.5	-5.5	Pass
2	36.21	58.25	3.47	-14.37	47.35	MaxQP	Vertical	100	146	49.5	-2.2	Pass

Test Notes: Model: SENSOR4-R2S1-I, S/N: 1517048. PoE powered and placed at 150cm non-conductive table.

This test report may be reproduced in full only. The document may only be updated by MiCOM Labs personnel. Any changes will be noted in the Document History section of the report.



Title: NetScout Systems Inc. SENSOR4 Product Family
To: FCC CFR 47 Part 15 Subpart E 15.407 & IC RSS-247
Serial #: NTCT77-U4 Rev B
Issue Date: 12th December 2016
Page: 52 of 128

Antenna:	Integral	Variant:	802.11a
Antenna Gain (dBi):	4.8	Modulation:	OFDM
Beam Forming Gain (Y):	Not Applicable	Duty Cycle (%):	99
Channel Frequency (MHz):	5785.00	Data Rate:	6 Mbit/s
Power Setting:	26	Tested By:	OC

Test Measurement Results



Variant: 802.11a, Test Freq: 5785.00 MHz, Antenna: Integral, Power Setting: 26, Duty Cycle (%): 99

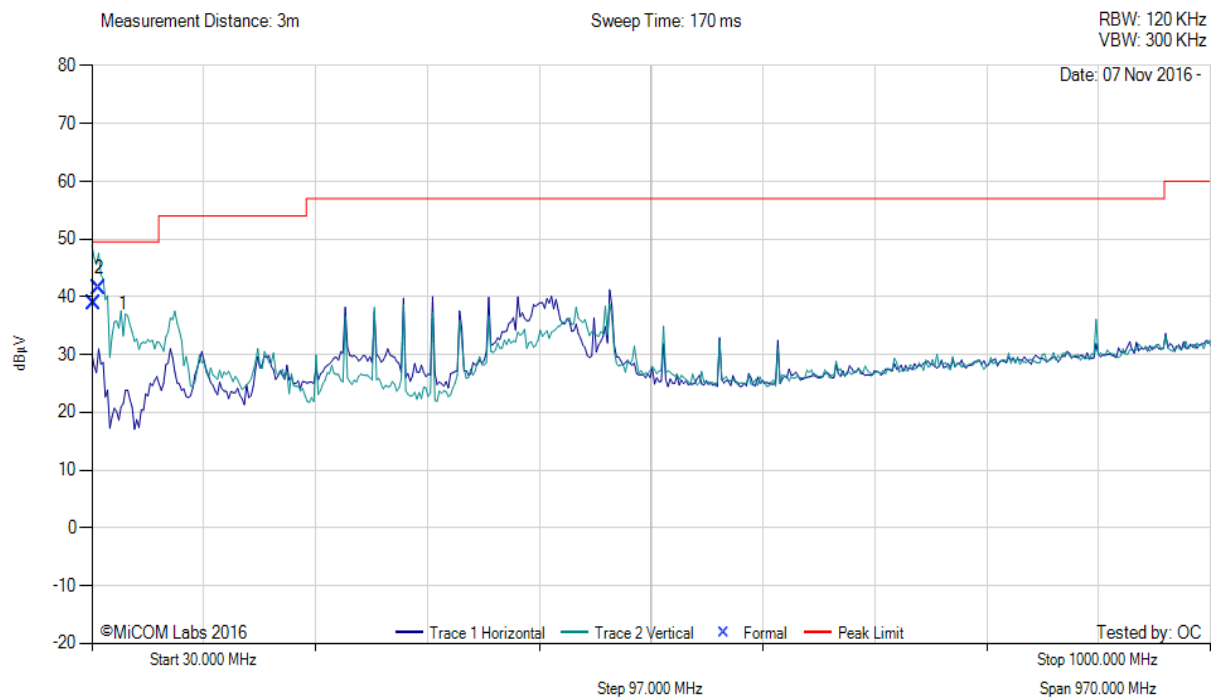

30.00 - 1000.00 MHz												
Num	Frequency MHz	Raw dBµV	Cable Loss dB	AF dB	Level dBµV/m	Measurement Type	Pol	Hgt cm	Azt Deg	Limit dBµV/m	Margin dB	Pass /Fail
1	31.84	46.62	3.44	-11.21	38.85	MaxQP	Vertical	100	49	49.5	-10.7	Pass
2	36.17	52.39	3.47	-14.37	41.49	MaxQP	Vertical	100	209	49.5	-8.0	Pass

Test Notes: Model: SENSOR4-R2S1-I, S/N: 1517048. PoE powered and placed at 150cm non-conductive table.

This test report may be reproduced in full only. The document may only be updated by MiCOM Labs personnel. Any changes will be noted in the Document History section of the report.



Title: NetScout Systems Inc. SENSOR4 Product Family
To: FCC CFR 47 Part 15 Subpart E 15.407 & IC RSS-247
Serial #: NTCT77-U4 Rev B
Issue Date: 12th December 2016
Page: 53 of 128

Above 1GHz

Antenna:	Laird Laird NanoGreen	Variant:	802.11a
Antenna Gain (dBi):	2.0	Modulation:	OFDM
Beam Forming Gain (Y):	Not Applicable	Duty Cycle (%):	99
Channel Frequency (MHz):	5200.00	Data Rate:	6.00 MBit/s
Power Setting:	10	Tested By:	JMH

Test Measurement Results



TX SPURIOUS & RESTRICTED BAND EMISSIONS

Variant: 802.11a, Test Freq: 5200.00 MHz, Antenna: Laird Laird NanoGreen, Power Setting: 10, Duty Cycle (%): 99

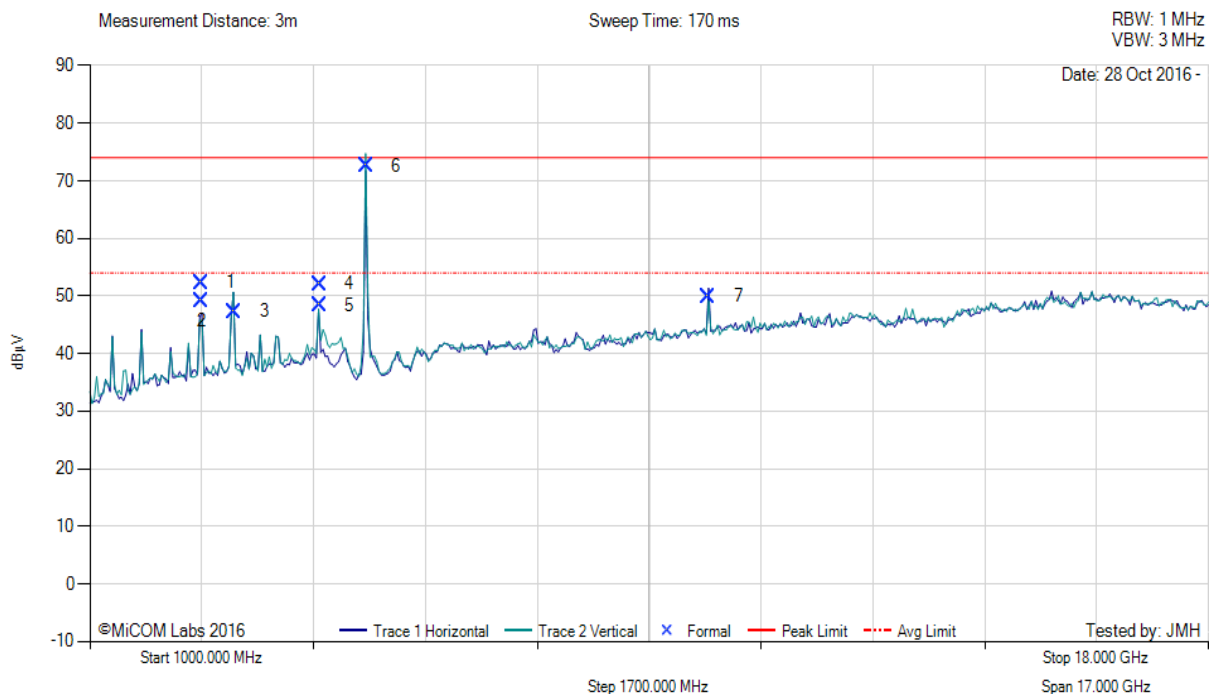

1000.00 - 18000.00 MHz												
Num	Frequency MHz	Raw dBµV	Cable Loss dB	AF dB	Level dBµV/m	Measurement Type	Pol	Hgt cm	Azt Deg	Limit dBµV/m	Margin dB	Pass /Fail
1	2699.92	60.86	2.84	-11.39	52.31	Max Peak	Horizontal	147	352	74.0	-21.7	Pass
2	2699.92	57.76	2.84	-11.39	49.21	Max Avg	Horizontal	147	352	54.0	-4.8	Pass
3	3199.72	55.60	3.00	-11.29	47.31	Peak (NRB)	Horizontal	151	80	--	--	Pass
4	4500.01	60.17	3.49	-11.60	52.06	Max Peak	Horizontal	186	172	74.0	-21.9	Pass
5	4500.01	56.51	3.49	-11.60	48.40	Max Avg	Horizontal	186	172	54.0	-5.6	Pass
6	5201.80	80.38	3.66	-11.46	72.58	Fundamental	Vertical	101	1	--	--	
7	10404.61	49.45	5.44	-5.00	49.89	Peak (NRB)	Horizontal	101	62	--	--	Pass

Test Notes: EUT powered by 3501G POE and connected to laptop inside chamber.

This test report may be reproduced in full only. The document may only be updated by MiCOM Labs personnel. Any changes will be noted in the Document History section of the report.



Title: NetScout Systems Inc. SENSOR4 Product Family
To: FCC CFR 47 Part 15 Subpart E 15.407 & IC RSS-247
Serial #: NTCT77-U4 Rev B
Issue Date: 12th December 2016
Page: 54 of 128

Antenna:	Laird Laird NanoGreen	Variant:	802.11a
Antenna Gain (dBi):	2.0	Modulation:	OFDM
Beam Forming Gain (Y):	Not Applicable	Duty Cycle (%):	99
Channel Frequency (MHz):	5300.00	Data Rate:	6.00 MBit/s
Power Setting:	17	Tested By:	JMH

Test Measurement Results



TX SPURIOUS & RESTRICTED BAND EMISSIONS

Variant: 802.11a, Test Freq: 5300.00 MHz, Antenna: Laird Laird NanoGreen, Power Setting: 17, Duty Cycle (%): 99

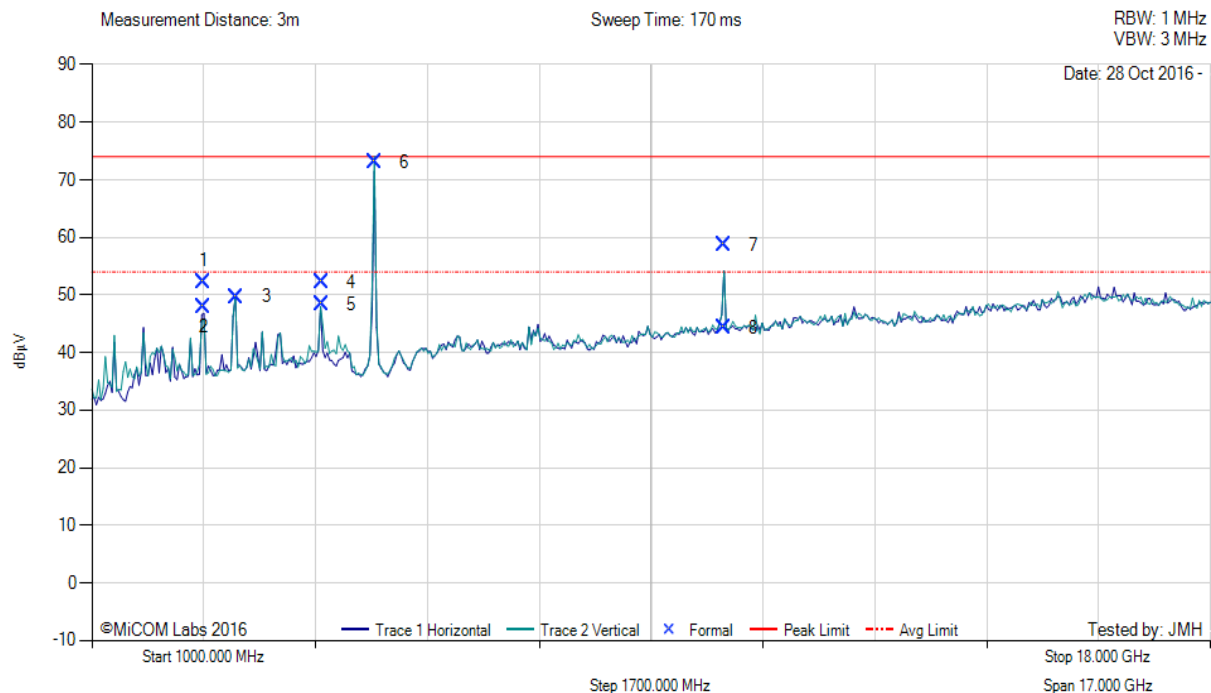

1000.00 - 18000.00 MHz												
Num	Frequency MHz	Raw dBµV	Cable Loss dB	AF dB	Level dBµV/m	Measurement Type	Pol	Hgt cm	Azt Deg	Limit dBµV/m	Margin dB	Pass /Fail
1	2699.95	60.86	2.84	-11.39	52.31	Max Peak	Horizontal	110	0	74.0	-21.7	Pass
2	2699.95	56.53	2.84	-11.39	47.98	Max Avg	Horizontal	110	0	54.0	-6.0	Pass
3	3199.88	58.00	3.00	-11.29	49.71	Peak (NRB)	Horizontal	101	141	--	--	Pass
4	4500.01	60.31	3.49	-11.60	52.20	Max Peak	Horizontal	195	169	74.0	-21.8	Pass
5	4500.01	56.55	3.49	-11.60	48.44	Max Avg	Horizontal	195	169	54.0	-5.6	Pass
6	5294.31	80.44	3.78	-11.12	73.10	Fundamental	Vertical	101	1	--	--	
7	10600.37	56.97	5.58	-3.94	58.61	Max Peak	Vertical	194	205	74.0	-15.4	Pass
8	10600.37	42.61	5.58	-3.94	44.25	Max Avg	Vertical	194	205	54.0	-9.8	Pass

Test Notes: EUT powered by 3501G POE and connected to laptop inside chamber.

This test report may be reproduced in full only. The document may only be updated by MiCOM Labs personnel. Any changes will be noted in the Document History section of the report.



Title: NetScout Systems Inc. SENSOR4 Product Family
To: FCC CFR 47 Part 15 Subpart E 15.407 & IC RSS-247
Serial #: NTCT77-U4 Rev B
Issue Date: 12th December 2016
Page: 55 of 128

Antenna:	Laird Laird NanoGreen	Variant:	802.11a
Antenna Gain (dBi):	2.0	Modulation:	OFDM
Beam Forming Gain (Y):	Not Applicable	Duty Cycle (%):	99
Channel Frequency (MHz):	5580.00	Data Rate:	6.00 MBit/s
Power Setting:	18	Tested By:	JMH

Test Measurement Results



TX SPURIOUS & RESTRICTED BAND EMISSIONS

Variant: 802.11a, Test Freq: 5580.00 MHz, Antenna: Laird Laird NanoGreen, Power Setting: 18, Duty Cycle (%): 99

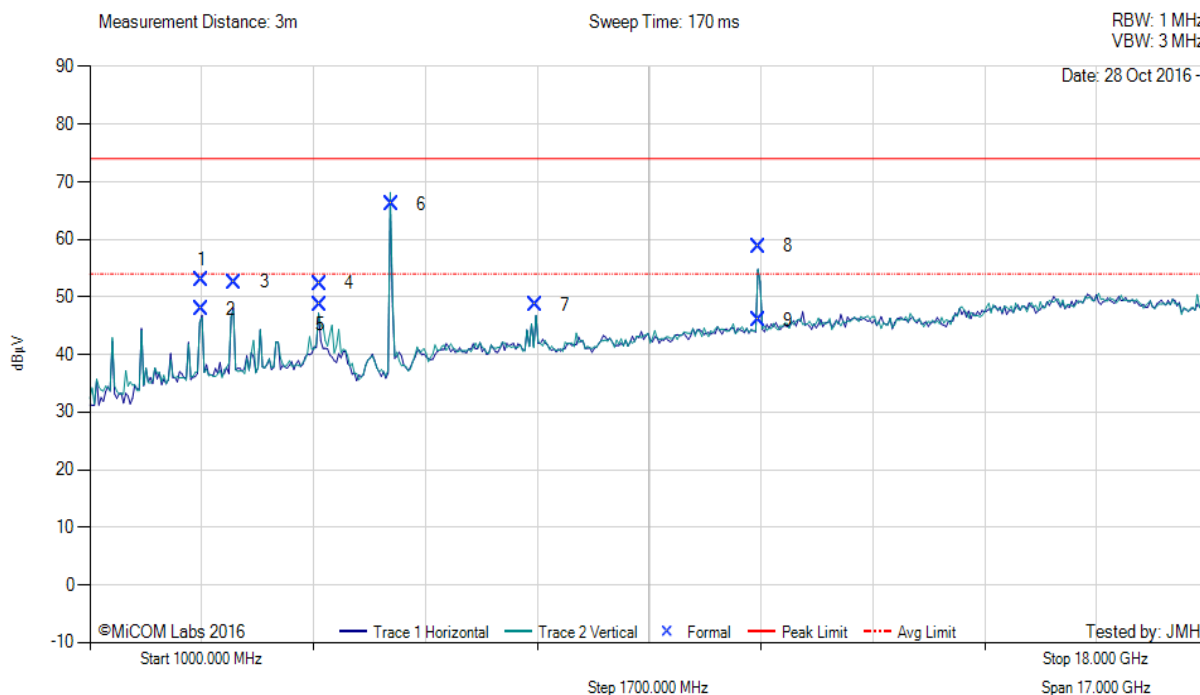

1000.00 - 18000.00 MHz												
Num	Frequency MHz	Raw dBµV	Cable Loss dB	AF dB	Level dBµV/m	Measurement Type	Pol	Hgt cm	Azt Deg	Limit dBµV/m	Margin dB	Pass /Fail
1	2699.87	61.41	2.84	-11.39	52.86	Max Peak	Horizontal	184	0	74.0	-21.1	Pass
2	2699.87	56.50	2.84	-11.39	47.95	Max Avg	Horizontal	184	0	54.0	-6.1	Pass
3	3199.96	60.83	3.00	-11.29	52.54	Peak (NRB)	Horizontal	101	136	--	--	Pass
4	4500.01	60.45	3.49	-11.60	52.34	Max Peak	Horizontal	188	168	74.0	-21.7	Pass
5	4500.01	56.84	3.49	-11.60	48.73	Max Avg	Horizontal	188	168	54.0	-5.3	Pass
6	5578.16	73.50	3.81	-11.20	66.11	Fundamental	Vertical	101	1	--	--	
7	7766.52	50.96	4.43	-6.71	48.68	Peak (NRB)	Horizontal	151	155	--	--	Pass
8	11161.86	57.09	5.76	-4.06	58.79	Max Peak	Vertical	191	331	74.0	-15.2	Pass
9	11161.86	44.21	5.76	-4.06	45.91	Max Avg	Vertical	191	331	54.0	-8.1	Pass

Test Notes: EUT powered by 3501G POE and connected to laptop inside chamber.

This test report may be reproduced in full only. The document may only be updated by MiCOM Labs personnel. Any changes will be noted in the Document History section of the report.



Title: NetScout Systems Inc. SENSOR4 Product Family
To: FCC CFR 47 Part 15 Subpart E 15.407 & IC RSS-247
Serial #: NTCT77-U4 Rev B
Issue Date: 12th December 2016
Page: 56 of 128

Antenna:	Integral	Variant:	802.11a
Antenna Gain (dBi):	4.8	Modulation:	OFDM
Beam Forming Gain (Y):	Not Applicable	Duty Cycle (%):	99
Channel Frequency (MHz):	5785.00	Data Rate:	6 Mbit/s
Power Setting:	26	Tested By:	OC

Test Measurement Results



Variant: 802.11a, Test Freq: 5785.00 MHz, Antenna: Integral, Power Setting: 26, Duty Cycle (%): 99

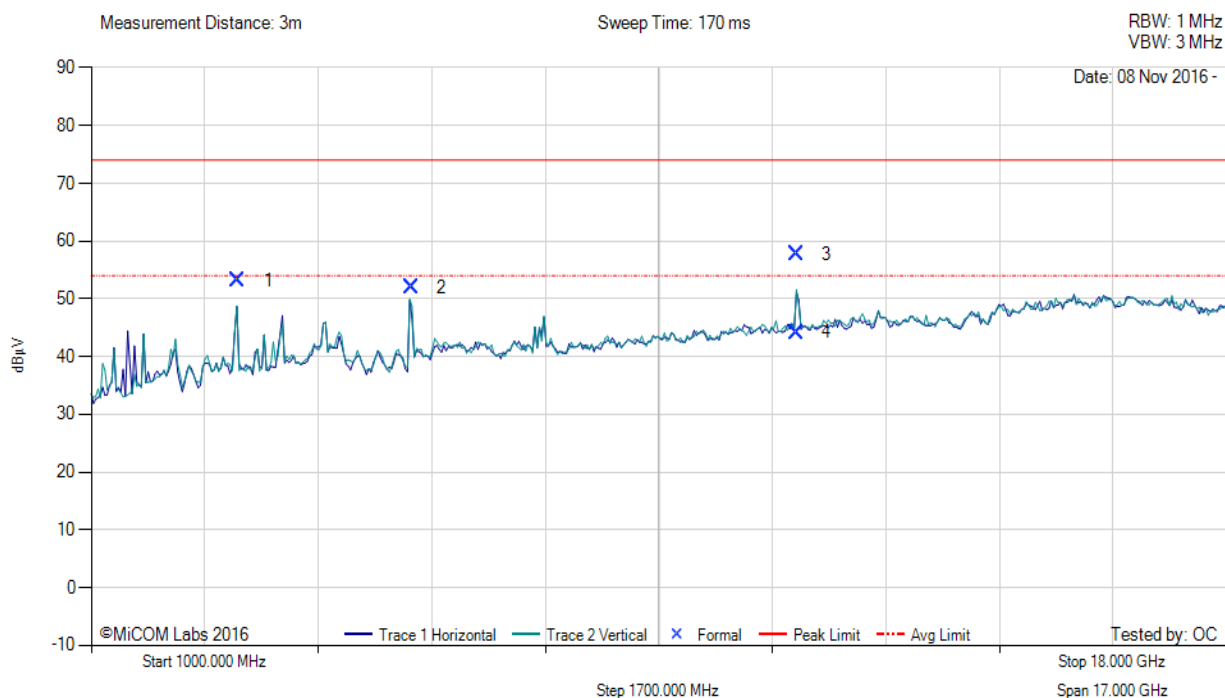

1000.00 - 18000.00 MHz												
Num	Frequency MHz	Raw dBµV	Cable Loss dB	AF dB	Level dBµV/m	Measurement Type	Pol	Hgt cm	Azt Deg	Limit dBµV/m	Margin dB	Pass /Fail
1	3200.00	61.51	3.00	-11.29	53.22	Peak (NRB)	Horizontal	200	0	--	--	Pass
2	5791.24	58.62	3.79	-10.41	52.00	Fundamental	Horizontal	100	111	--	--	
3	11568.21	56.85	5.50	-4.65	57.70	Max Peak	Vertical	175	294	74.0	-16.3	Pass
4	11568.21	43.33	5.50	-4.65	44.18	Max Avg	Vertical	175	294	54.0	-9.8	Pass

Test Notes: Model: SENSOR4-R2S1-I, S/N: 1517048. PoE powered and placed at 150cm non-conductive table.

This test report may be reproduced in full only. The document may only be updated by MiCOM Labs personnel. Any changes will be noted in the Document History section of the report.



9.4.2. Restricted Band-Edge Emissions 15.407

5725 – 5850 MHz Band

Antenna:	Integral	Variant:	802.11a
Antenna Gain (dBi):	2.0	Modulation:	OFDM
Beam Forming Gain (Y):	Not Applicable	Duty Cycle (%):	99
Channel Frequency (MHz):	5745	Data Rate:	6 Mbit/s
Power Setting:	26	Tested By:	OC

Test Measurement Results



Variant: 802.11a, Test Freq: 5745 MHz, Antenna: Integral, Power Setting: 26, Duty Cycle (%): 99

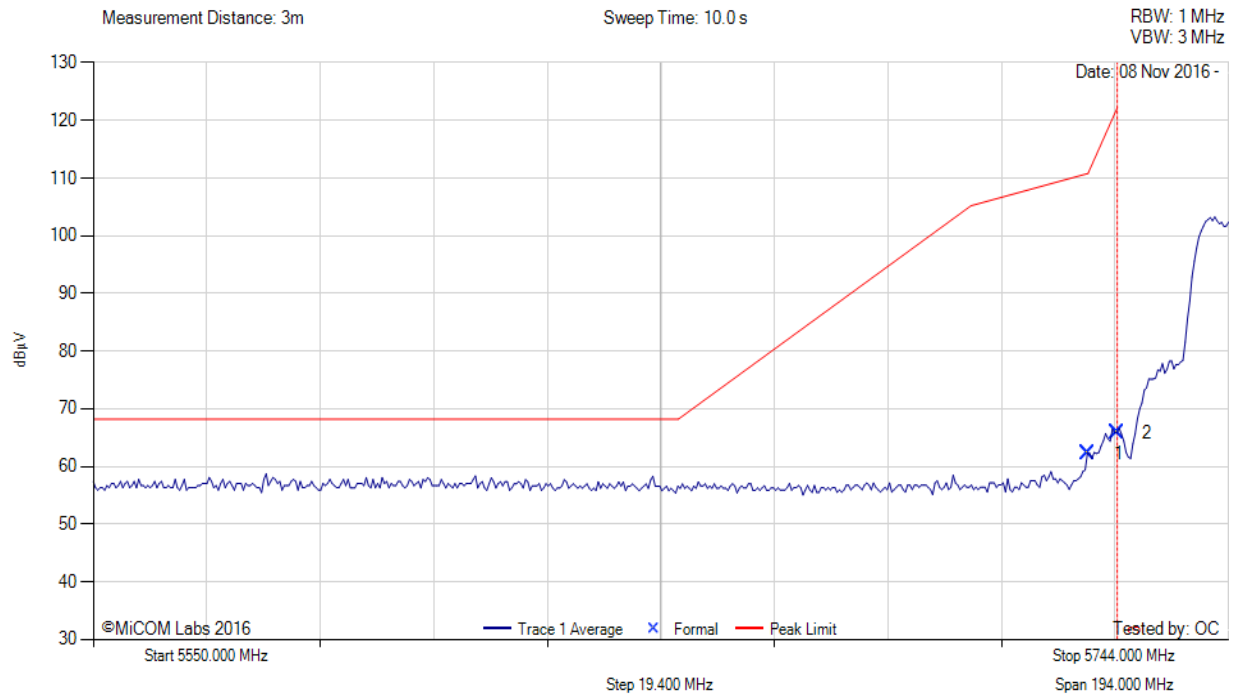

5550.00 - 5744.00 MHz												
Num	Frequency MHz	Raw dBµV	Cable Loss dB	AF dB	Level dBµV/m	Measurement Type	Pol	Hgt cm	Azt Deg	Limit dBµV/m	Margin dB	Pass /Fail
1	5720.05	24.10	3.80	34.35	62.25	Max Avg	Vertical	176	138	68.2	-6.0	Pass
2	5725.00	27.70	3.79	34.35	65.84	Max Avg	Vertical	176	138	122.2	-56.4	Pass
3	5725.00	--	--	--	--	Band-Edge	--	--	--	--	--	--

Test Notes: Model: SENSOR4-R2S1-I, S/N: 1517048. PoE powered and placed at 150cm non-conductive table.

This test report may be reproduced in full only. The document may only be updated by MiCOM Labs personnel. Any changes will be noted in the Document History section of the report.



Title: NetScout Systems Inc. SENSOR4 Product Family
To: FCC CFR 47 Part 15 Subpart E 15.407 & IC RSS-247
Serial #: NTCT77-U4 Rev B
Issue Date: 12th December 2016
Page: 58 of 128

Antenna:	Integral	Variant:	802.11n HT20
Antenna Gain (dBi):	2.0	Modulation:	OFDM
Beam Forming Gain (Y):	Not Applicable	Duty Cycle (%):	99
Channel Frequency (MHz):	5745	Data Rate:	6.5 Mbit/s
Power Setting:	26	Tested By:	OC

Test Measurement Results



Variant: 802.11n HT20, Test Freq: 5745 MHz, Antenna: Integral, Power Setting: 26, Duty Cycle (%): 99

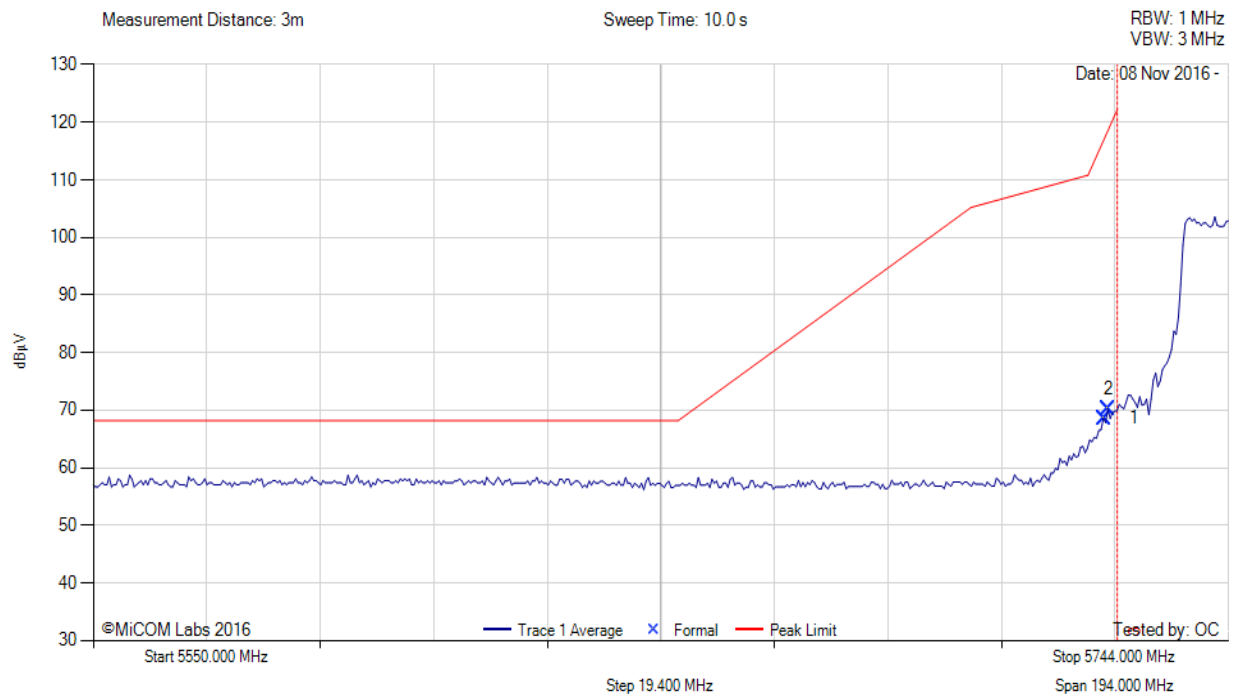

5550.00 - 5744.00 MHz												
Num	Frequency MHz	Raw dBµV	Cable Loss dB	AF dB	Level dBµV/m	Measurement Type	Pol	Hgt cm	Azt Deg	Limit dBµV/m	Margin dB	Pass /Fail
1	5722.72	30.42	3.80	34.35	68.57	Max Avg	Vertical	176	134	117.6	-49.1	Pass
2	5723.44	32.02	3.80	34.35	70.17	Max Avg	Vertical	176	134	117.6	-47.5	Pass
3	5725.00	--	--	--	--	Band-Edge	--	--	--	--	--	--

Test Notes: Model: SENSOR4-R2S1-I, S/N: 1517048. PoE powered and placed at 150cm non-conductive table.

This test report may be reproduced in full only. The document may only be updated by MiCOM Labs personnel. Any changes will be noted in the Document History section of the report.



Title: NetScout Systems Inc. SENSOR4 Product Family
To: FCC CFR 47 Part 15 Subpart E 15.407 & IC RSS-247
Serial #: NTCT77-U4 Rev B
Issue Date: 12th December 2016
Page: 59 of 128

Antenna:	Integral	Variant:	802.11n HT40
Antenna Gain (dBi):	2.0	Modulation:	OFDM
Beam Forming Gain (Y):	Not Applicable	Duty Cycle (%):	99
Channel Frequency (MHz):	5755	Data Rate:	13.5 Mbit/s
Power Setting:	25	Tested By:	OC

Test Measurement Results



Variant: 802.11n HT40, Test Freq: 5755 MHz, Antenna: Integral, Power Setting: 25, Duty Cycle (%): 99

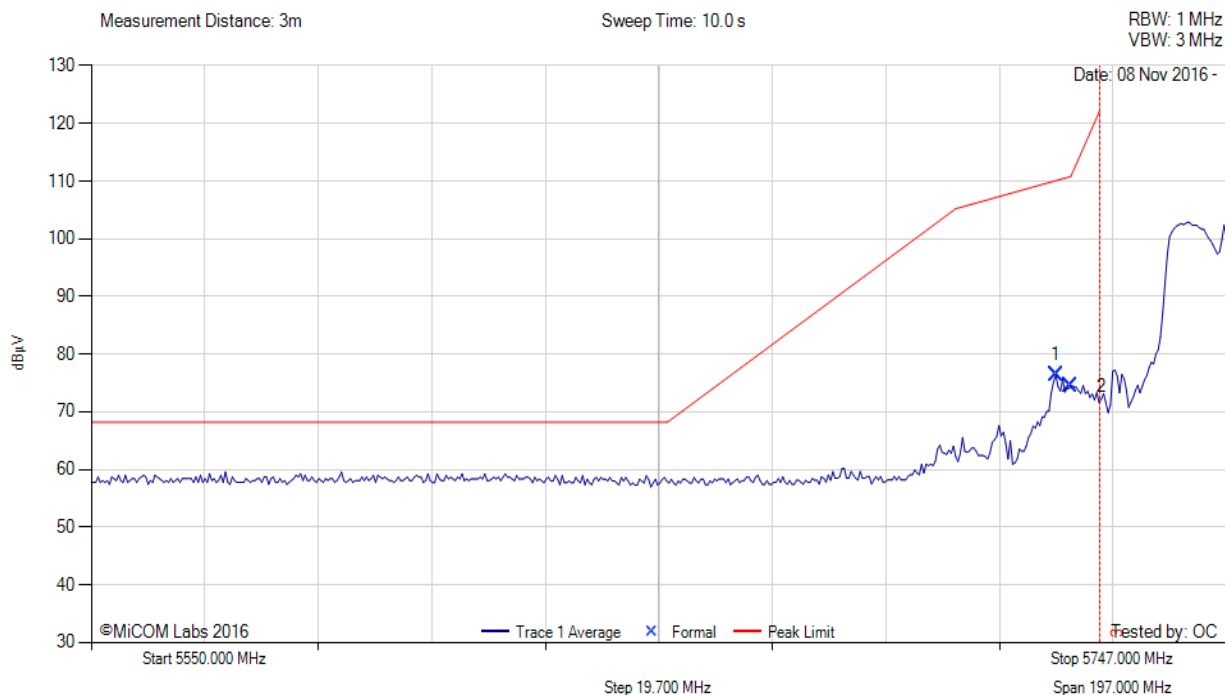

5550.00 - 5747.00 MHz												
Num	Frequency MHz	Raw dBµV	Cable Loss dB	AF dB	Level dBµV/m	Measurement Type	Pol	Hgt cm	Azt Deg	Limit dBµV/m	Margin dB	Pass /Fail
1	5717.37	38.19	3.81	34.34	76.34	Max Avg	Vertical	176	131	110.0	-33.6	Pass
2	5720.00	36.29	3.80	34.35	74.44	Max Avg	Vertical	176	131	78.2	-3.8	Pass
3	5725.00	--	--	--	--	Band-Edge	--	--	--	--	--	--

Test Notes: Model: SENSOR4-R2S1-I, S/N: 1517048. PoE powered and placed at 150cm non-conductive table. Reduced from 26 to 25.

This test report may be reproduced in full only. The document may only be updated by MiCOM Labs personnel. Any changes will be noted in the Document History section of the report.



Title: NetScout Systems Inc. SENSOR4 Product Family
To: FCC CFR 47 Part 15 Subpart E 15.407 & IC RSS-247
Serial #: NTCT77-U4 Rev B
Issue Date: 12th December 2016
Page: 60 of 128

Antenna:	Integral	Variant:	802.11a
Antenna Gain (dBi):	2.0	Modulation:	OFDM
Beam Forming Gain (Y):	Not Applicable	Duty Cycle (%):	99
Channel Frequency (MHz):	5825	Data Rate:	6 Mbit/s
Power Setting:	26	Tested By:	OC

Test Measurement Results



Variant: 802.11a, Test Freq: 5825 MHz, Antenna: Integral, Power Setting: 26, Duty Cycle (%): 99

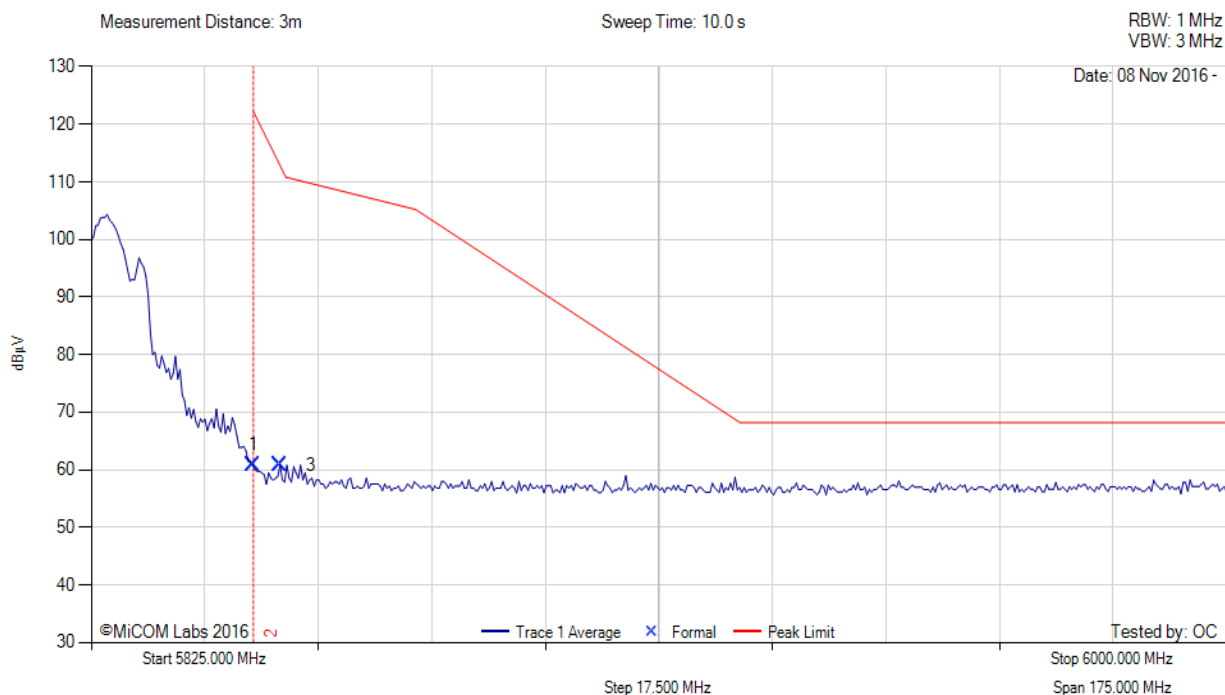

5825.00 - 6000.00 MHz												
Num	Frequency MHz	Raw dBµV	Cable Loss dB	AF dB	Level dBµV/m	Measurement Type	Pol	Hgt cm	Azt Deg	Limit dBµV/m	Margin dB	Pass /Fail
1	5850.00	22.35	3.81	34.63	60.79	Max Avg	Vertical	176	131	122.2	-61.4	Pass
3	5854.17	22.34	3.83	34.64	60.81	Max Avg	Vertical	176	131	113.1	-52.3	Pass
2	5850.00	--	--	--	--	Band-Edge	--	--	--	--	--	--

Test Notes: Model: SENSOR4-R2S1-I, S/N: 1517048. PoE powered and placed at 150cm non-conductive table.

This test report may be reproduced in full only. The document may only be updated by MiCOM Labs personnel. Any changes will be noted in the Document History section of the report.



Title: NetScout Systems Inc. SENSOR4 Product Family
To: FCC CFR 47 Part 15 Subpart E 15.407 & IC RSS-247
Serial #: NTCT77-U4 Rev B
Issue Date: 12th December 2016
Page: 61 of 128

Antenna:	Integral	Variant:	802.11n HT20
Antenna Gain (dBi):	2.0	Modulation:	OFDM
Beam Forming Gain (Y):	Not Applicable	Duty Cycle (%):	99
Channel Frequency (MHz):	5825	Data Rate:	6.5 Mbit/s
Power Setting:	26	Tested By:	OC

Test Measurement Results



Variant: 802.11n HT20, Test Freq: 5825 MHz, Antenna: Integral, Power Setting: 26, Duty Cycle (%): 99

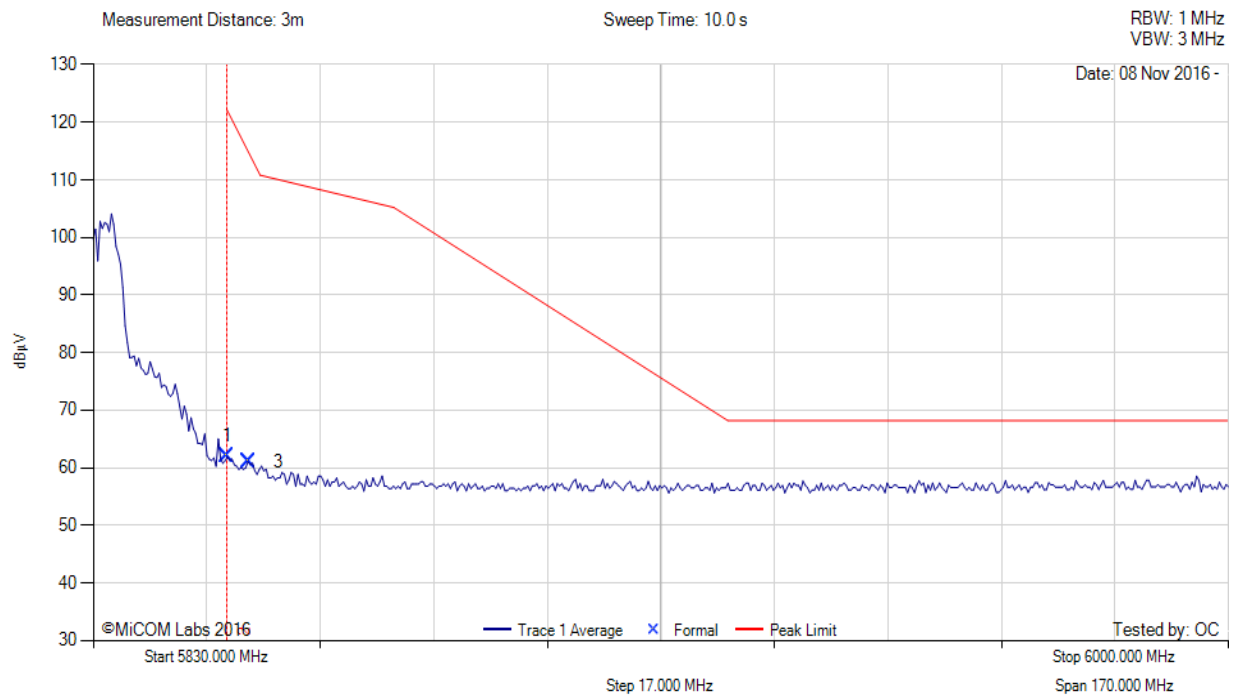

5830.00 - 6000.00 MHz												
Num	Frequency MHz	Raw dBµV	Cable Loss dB	AF dB	Level dBµV/m	Measurement Type	Pol	Hgt cm	Azt Deg	Limit dBµV/m	Margin dB	Pass /Fail
1	5850.00	23.51	3.81	34.63	61.95	Max Avg	Vertical	176	131	122.2	-60.3	Pass
3	5853.19	22.60	3.82	34.63	61.05	Max Avg	Vertical	176	131	115.4	-54.3	Pass
2	5850.00	--	--	--	--	Band-Edge	--	--	--	--	--	--

Test Notes: Model: SENSOR4-R2S1-I, S/N: 1517048. PoE powered and placed at 150cm non-conductive table.

This test report may be reproduced in full only. The document may only be updated by MiCOM Labs personnel. Any changes will be noted in the Document History section of the report.



Title: NetScout Systems Inc. SENSOR4 Product Family
To: FCC CFR 47 Part 15 Subpart E 15.407 & IC RSS-247
Serial #: NTCT77-U4 Rev B
Issue Date: 12th December 2016
Page: 62 of 128

Antenna:	Integral	Variant:	802.11n HT40
Antenna Gain (dBi):	2.0	Modulation:	OFDM
Beam Forming Gain (Y):	Not Applicable	Duty Cycle (%):	99
Channel Frequency (MHz):	5795	Data Rate:	13.5 Mbit/s
Power Setting:	25	Tested By:	OC

Test Measurement Results



Variant: 802.11n HT40, Test Freq: 5795 MHz, Antenna: Integral, Power Setting: 25, Duty Cycle (%): 99

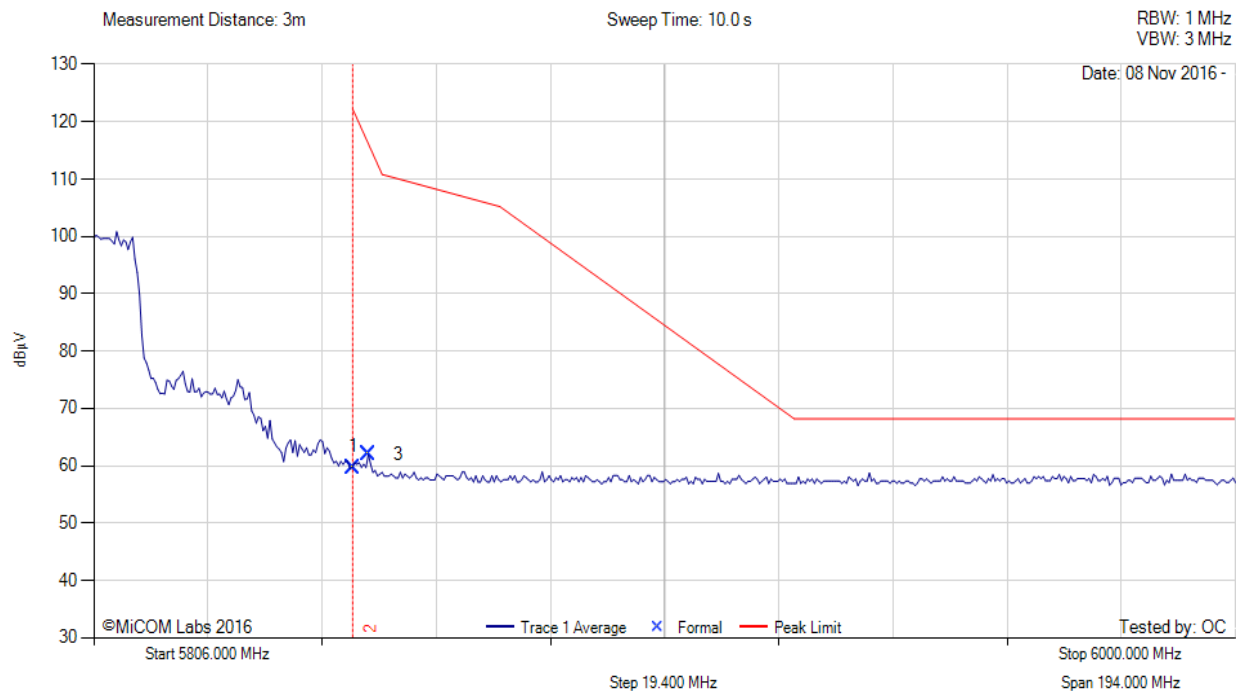

5806.00 - 6000.00 MHz												
Num	Frequency MHz	Raw dBµV	Cable Loss dB	AF dB	Level dBµV/m	Measurement Type	Pol	Hgt cm	Azt Deg	Limit dBµV/m	Margin dB	Pass /Fail
1	5850.00	21.30	3.81	34.63	59.74	Max Avg	Vertical	176	131	122.2	-62.5	Pass
3	5852.61	23.51	3.82	34.63	61.96	Max Avg	Vertical	176	131	115.4	-53.4	Pass
2	5850.00	--	--	--	--	Band-Edge	--	--	--	--	--	--

Test Notes: Model: SENSOR4-R2S1-I, S/N: 1517048. PoE powered and placed at 150cm non-conductive table.

This test report may be reproduced in full only. The document may only be updated by MiCOM Labs personnel. Any changes will be noted in the Document History section of the report.



9.4.3. Restricted Band-Edge Emissions RSS 247

5725 – 5850 MHz Band

Antenna:	Integral	Variant:	802.11a
Antenna Gain (dBi):	2.0	Modulation:	OFDM
Beam Forming Gain (Y):	Not Applicable	Duty Cycle (%):	99
Channel Frequency (MHz):	5745	Data Rate:	6 Mbit/s
Power Setting:	26	Tested By:	OC

Test Measurement Results



Variant: 802.11a, Test Freq: 5745 MHz, Antenna: Integral, Power Setting: 26, Duty Cycle (%): 99

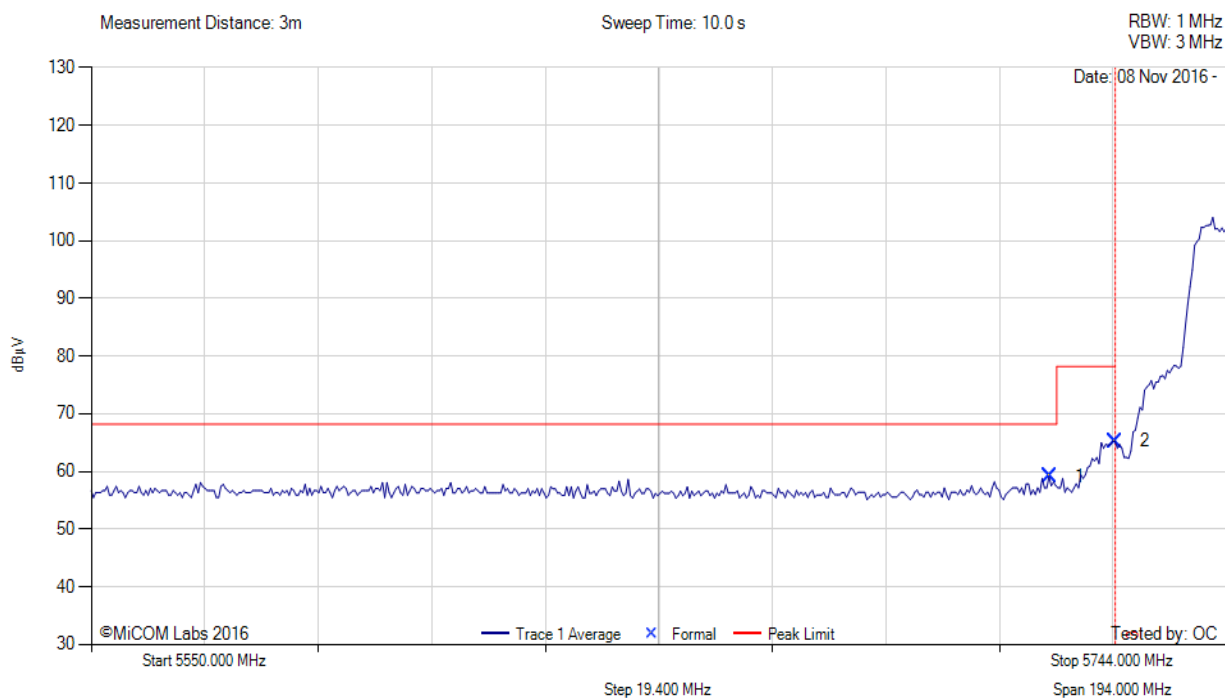

5550.00 - 5744.00 MHz												
Num	Frequency MHz	Raw dBµV	Cable Loss dB	AF dB	Level dBµV/m	Measurement Type	Pol	Hgt cm	Azt Deg	Limit dBµV/m	Margin dB	Pass /Fail
1	5713.83	20.95	3.82	34.34	59.11	Max Avg	Vertical	176	138	68.2	-9.1	Pass
2	5725.00	27.15	3.79	34.35	65.29	Max Avg	Vertical	176	138	78.2	-12.9	Pass
3	5725.00	--	--	--	--	Band-Edge	--	--	--	--	--	--

Test Notes: Model: SENSOR4-R2S1-I, S/N: 1517048. PoE powered and placed at 150cm non-conductive table.

This test report may be reproduced in full only. The document may only be updated by MiCOM Labs personnel. Any changes will be noted in the Document History section of the report.



Title: NetScout Systems Inc. SENSOR4 Product Family
To: FCC CFR 47 Part 15 Subpart E 15.407 & IC RSS-247
Serial #: NTCT77-U4 Rev B
Issue Date: 12th December 2016
Page: 64 of 128

Antenna:	Integral	Variant:	802.11n HT20
Antenna Gain (dBi):	2.0	Modulation:	OFDM
Beam Forming Gain (Y):	Not Applicable	Duty Cycle (%):	99
Channel Frequency (MHz):	5745	Data Rate:	6.5 Mbit/s
Power Setting:	26	Tested By:	OC

Test Measurement Results



Variant: 802.11n HT20, Test Freq: 5745 MHz, Antenna: Integral, Power Setting: 26, Duty Cycle (%): 99

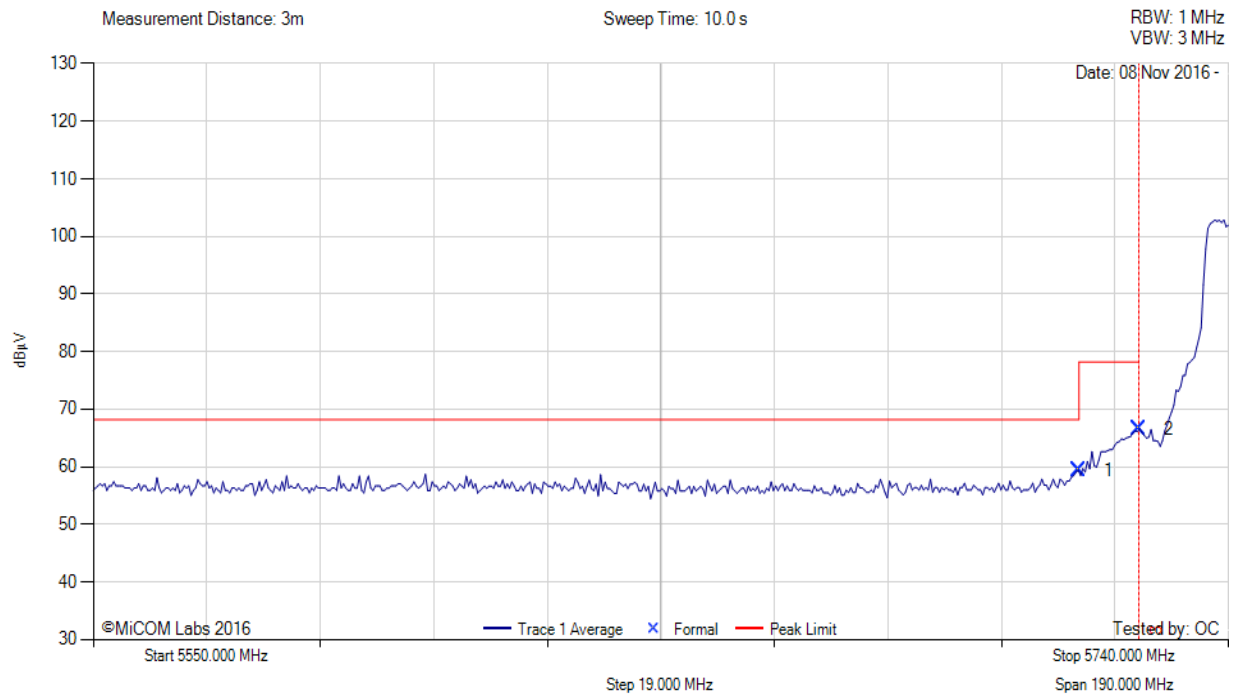

5550.00 - 5740.00 MHz												
Num	Frequency MHz	Raw dBµV	Cable Loss dB	AF dB	Level dBµV/m	Measurement Type	Pol	Hgt cm	Azt Deg	Limit dBµV/m	Margin dB	Pass /Fail
1	5715.00	21.25	3.81	34.34	59.40	Max Avg	Vertical	176	134	68.2	-8.8	Pass
2	5725.00	28.47	3.79	34.35	66.61	Max Avg	Vertical	176	134	78.2	-11.6	Pass
3	5725.00	--	--	--	--	Band-Edge	--	--	--	--	--	--

Test Notes: Model: SENSOR4-R2S1-I, S/N: 1517048. PoE powered and placed at 150cm non-conductive table.

This test report may be reproduced in full only. The document may only be updated by MiCOM Labs personnel. Any changes will be noted in the Document History section of the report.



Title: NetScout Systems Inc. SENSOR4 Product Family
To: FCC CFR 47 Part 15 Subpart E 15.407 & IC RSS-247
Serial #: NTCT77-U4 Rev B
Issue Date: 12th December 2016
Page: 65 of 128

Antenna:	Integral	Variant:	802.11n HT40
Antenna Gain (dBi):	2.0	Modulation:	OFDM
Beam Forming Gain (Y):	Not Applicable	Duty Cycle (%):	99
Channel Frequency (MHz):	5755	Data Rate:	13.5 Mbit/s
Power Setting:	25	Tested By:	OC

Test Measurement Results



Variant: 802.11n HT40, Test Freq: 5755 MHz, Antenna: Integral, Power Setting: 25, Duty Cycle (%): 99

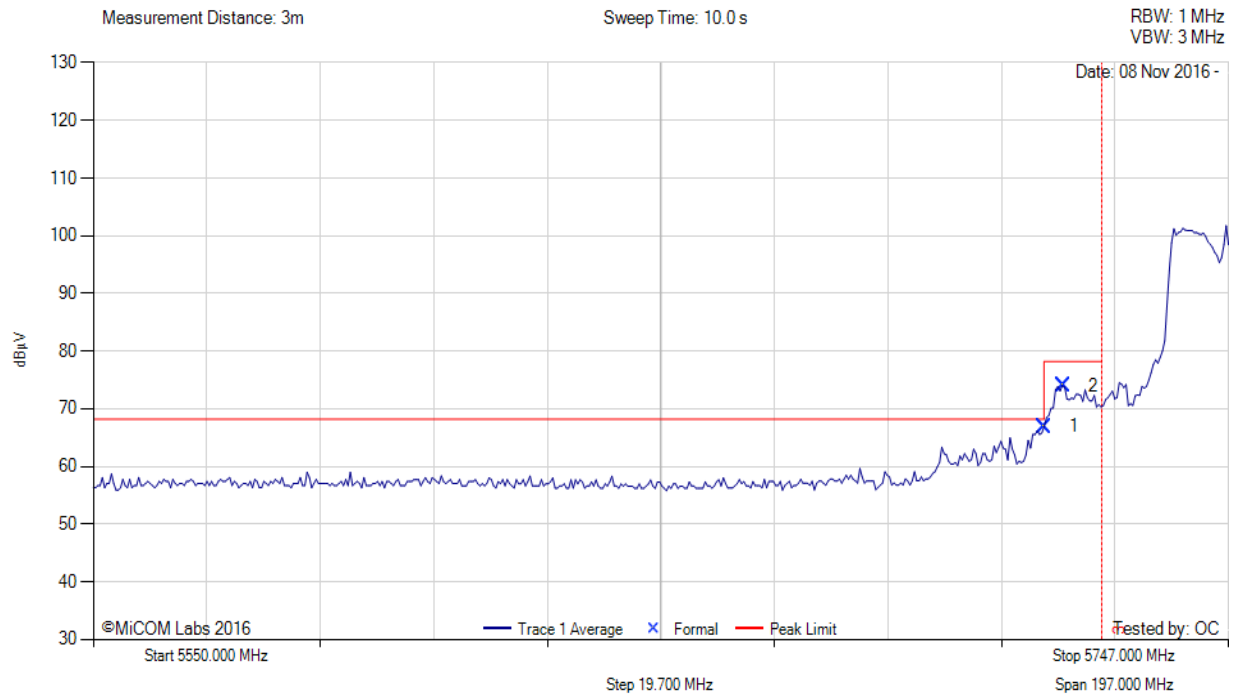

5550.00 - 5747.00 MHz												
Num	Frequency MHz	Raw dBµV	Cable Loss dB	AF dB	Level dBµV/m	Measurement Type	Pol	Hgt cm	Azt Deg	Limit dBµV/m	Margin dB	Pass /Fail
1	5715.00	28.80	3.81	34.34	66.95	Max Avg	Vertical	176	131	68.2	-1.3	Pass
2	5718.29	35.88	3.81	34.34	74.03	Max Avg	Vertical	176	131	78.2	-4.2	Pass
3	5725.00	--	--	--	--	Band-Edge	--	--	--	--	--	--

Test Notes: Model: SENSOR4-R2S1-I, S/N: 1517048. PoE powered and placed at 150cm non-conductive table. Reduced from 26 to 25.

This test report may be reproduced in full only. The document may only be updated by MiCOM Labs personnel. Any changes will be noted in the Document History section of the report.



Title: NetScout Systems Inc. SENSOR4 Product Family
To: FCC CFR 47 Part 15 Subpart E 15.407 & IC RSS-247
Serial #: NTCT77-U4 Rev B
Issue Date: 12th December 2016
Page: 66 of 128

Antenna:	Integral	Variant:	802.11a
Antenna Gain (dBi):	2.0	Modulation:	OFDM
Beam Forming Gain (Y):	Not Applicable	Duty Cycle (%):	99
Channel Frequency (MHz):	5825	Data Rate:	6 Mbit/s
Power Setting:	26	Tested By:	OC

Test Measurement Results



Variant: 802.11a, Test Freq: 5825 MHz, Antenna: Integral, Power Setting: 26, Duty Cycle (%): 99

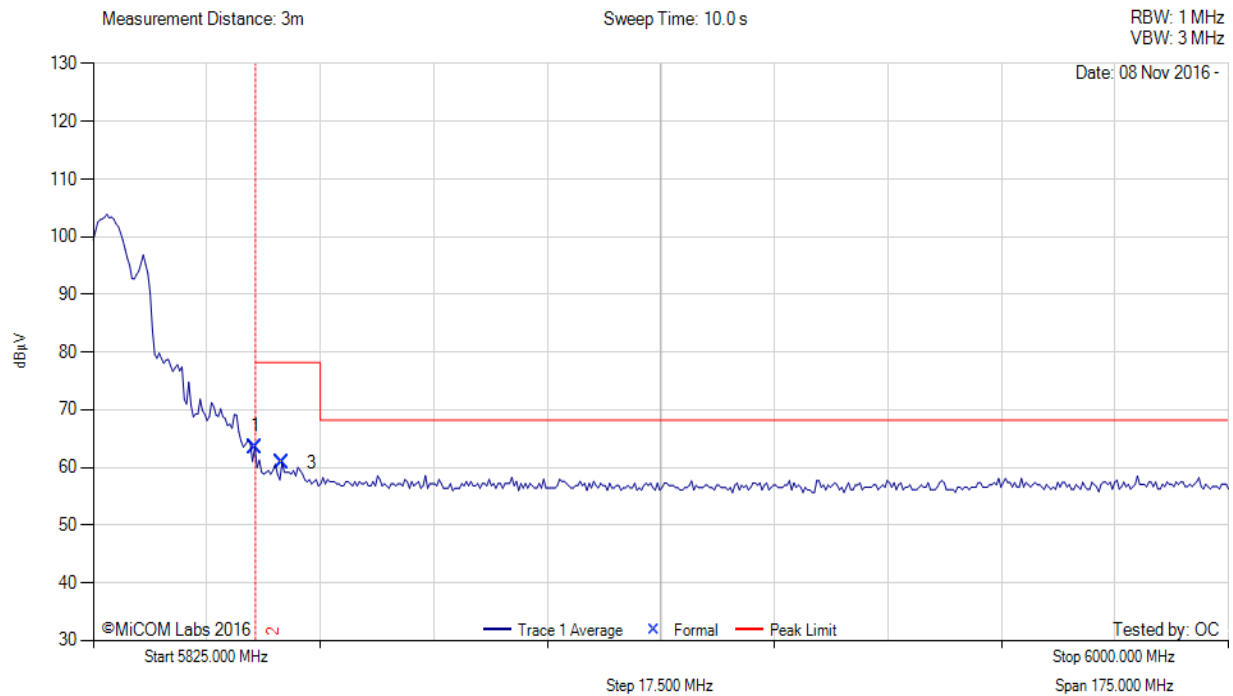

5825.00 - 6000.00 MHz												
Num	Frequency MHz	Raw dBµV	Cable Loss dB	AF dB	Level dBµV/m	Measurement Type	Pol	Hgt cm	Azt Deg	Limit dBµV/m	Margin dB	Pass /Fail
1	5850.00	25.10	3.81	34.63	63.54	Max Avg	Vertical	176	131	78.2	-14.7	Pass
3	5854.04	22.34	3.83	34.64	60.81	Max Avg	Vertical	176	131	68.2	-7.4	Pass
2	5850.00	--	--	--	--	Band-Edge	--	--	--	--	--	--

Test Notes: Model: SENSOR4-R2S1-I, S/N: 1517048. PoE powered and placed at 150cm non-conductive table.

This test report may be reproduced in full only. The document may only be updated by MiCOM Labs personnel. Any changes will be noted in the Document History section of the report.



Title: NetScout Systems Inc. SENSOR4 Product Family
To: FCC CFR 47 Part 15 Subpart E 15.407 & IC RSS-247
Serial #: NTCT77-U4 Rev B
Issue Date: 12th December 2016
Page: 67 of 128

Antenna:	Integral	Variant:	802.11n HT20
Antenna Gain (dBi):	2.0	Modulation:	OFDM
Beam Forming Gain (Y):	Not Applicable	Duty Cycle (%):	99
Channel Frequency (MHz):	5825	Data Rate:	6.5 Mbit/s
Power Setting:	26	Tested By:	OC

Test Measurement Results



Variant: 802.11n HT20, Test Freq: 5825 MHz, Antenna: Integral, Power Setting: 26, Duty Cycle (%): 99

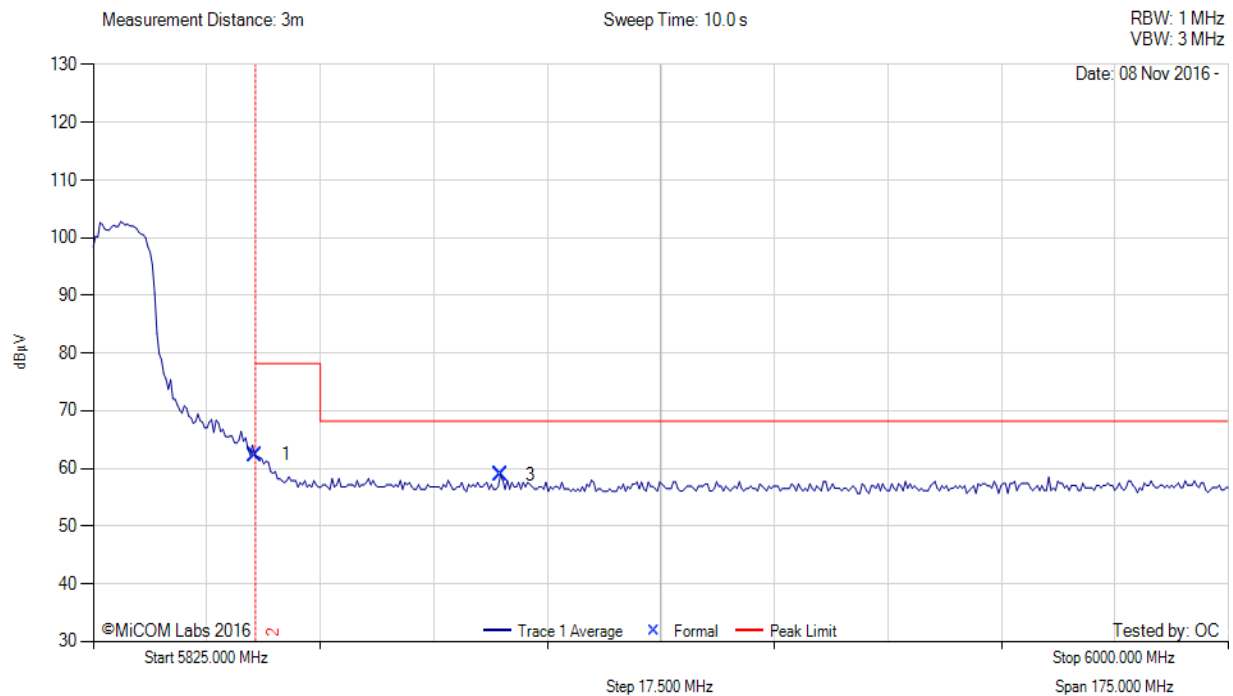

5825.00 - 6000.00 MHz												
Num	Frequency MHz	Raw dBµV	Cable Loss dB	AF dB	Level dBµV/m	Measurement Type	Pol	Hgt cm	Azt Deg	Limit dBµV/m	Margin dB	Pass /Fail
1	5850.00	23.94	3.81	34.63	62.38	Max Avg	Vertical	176	131	78.2	-15.9	Pass
3	5887.71	20.38	3.82	34.73	58.93	Max Avg	Vertical	176	131	68.2	-9.3	Pass
2	5850.00	--	--	--	--	Band-Edge	--	--	--	--	--	--

Test Notes: Model: SENSOR4-R2S1-I, S/N: 1517048. PoE powered and placed at 150cm non-conductive table.

This test report may be reproduced in full only. The document may only be updated by MiCOM Labs personnel. Any changes will be noted in the Document History section of the report.



Title: NetScout Systems Inc. SENSOR4 Product Family
To: FCC CFR 47 Part 15 Subpart E 15.407 & IC RSS-247
Serial #: NTCT77-U4 Rev B
Issue Date: 12th December 2016
Page: 68 of 128

Antenna:	Integral	Variant:	802.11n HT40
Antenna Gain (dBi):	2.0	Modulation:	OFDM
Beam Forming Gain (Y):	Not Applicable	Duty Cycle (%):	99
Channel Frequency (MHz):	5795	Data Rate:	13.5 Mbit/s
Power Setting:	25	Tested By:	OC

Test Measurement Results



Variant: 802.11n HT40, Test Freq: 5795 MHz, Antenna: Integral, Power Setting: 25, Duty Cycle (%): 99

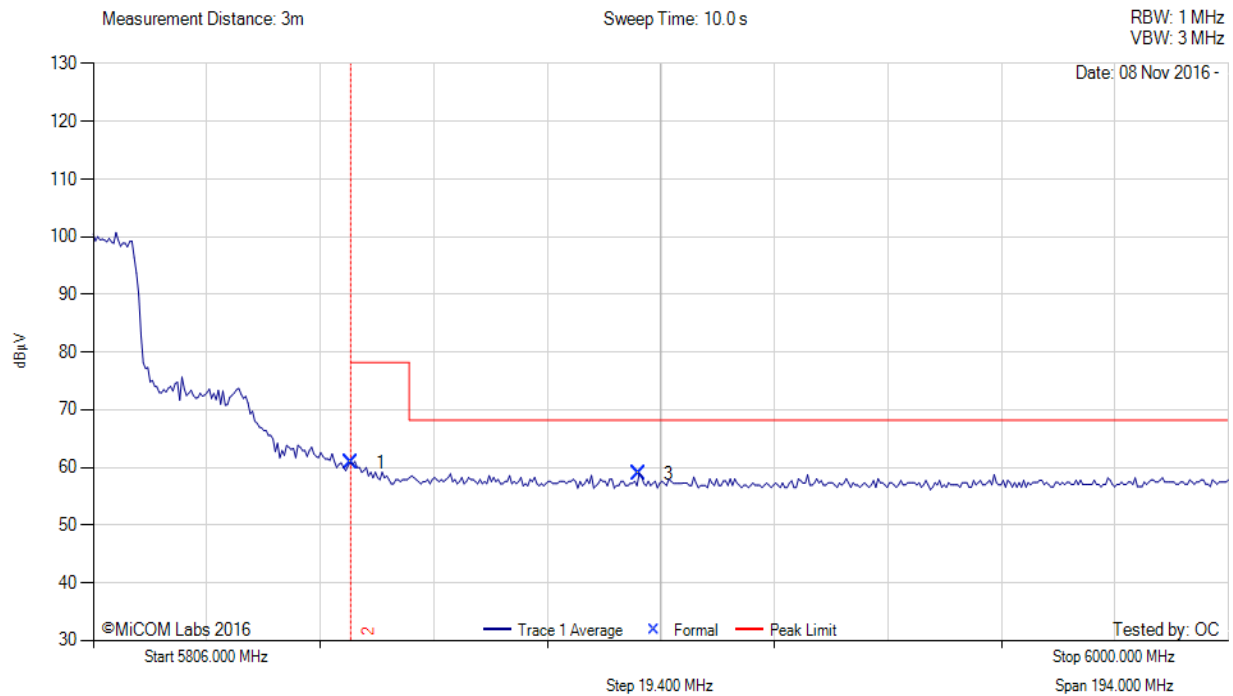

5806.00 - 6000.00 MHz												
Num	Frequency MHz	Raw dBµV	Cable Loss dB	AF dB	Level dBµV/m	Measurement Type	Pol	Hgt cm	Azt Deg	Limit dBµV/m	Margin dB	Pass /Fail
1	5850.00	22.35	3.81	34.63	60.79	Max Avg	Vertical	176	131	78.2	-17.4	Pass
3	5899.27	20.38	3.82	34.76	58.96	Max Avg	Vertical	176	131	68.2	-9.3	Pass
2	5850.00	--	--	--	--	Band-Edge	--	--	--	--	--	--

Test Notes: Model: SENSOR4-R2S1-I, S/N: 1517048. PoE powered and placed at 150cm non-conductive table.

This test report may be reproduced in full only. The document may only be updated by MiCOM Labs personnel. Any changes will be noted in the Document History section of the report.

PHOTOGRAPHS

Radiated Emissions below 1GHz

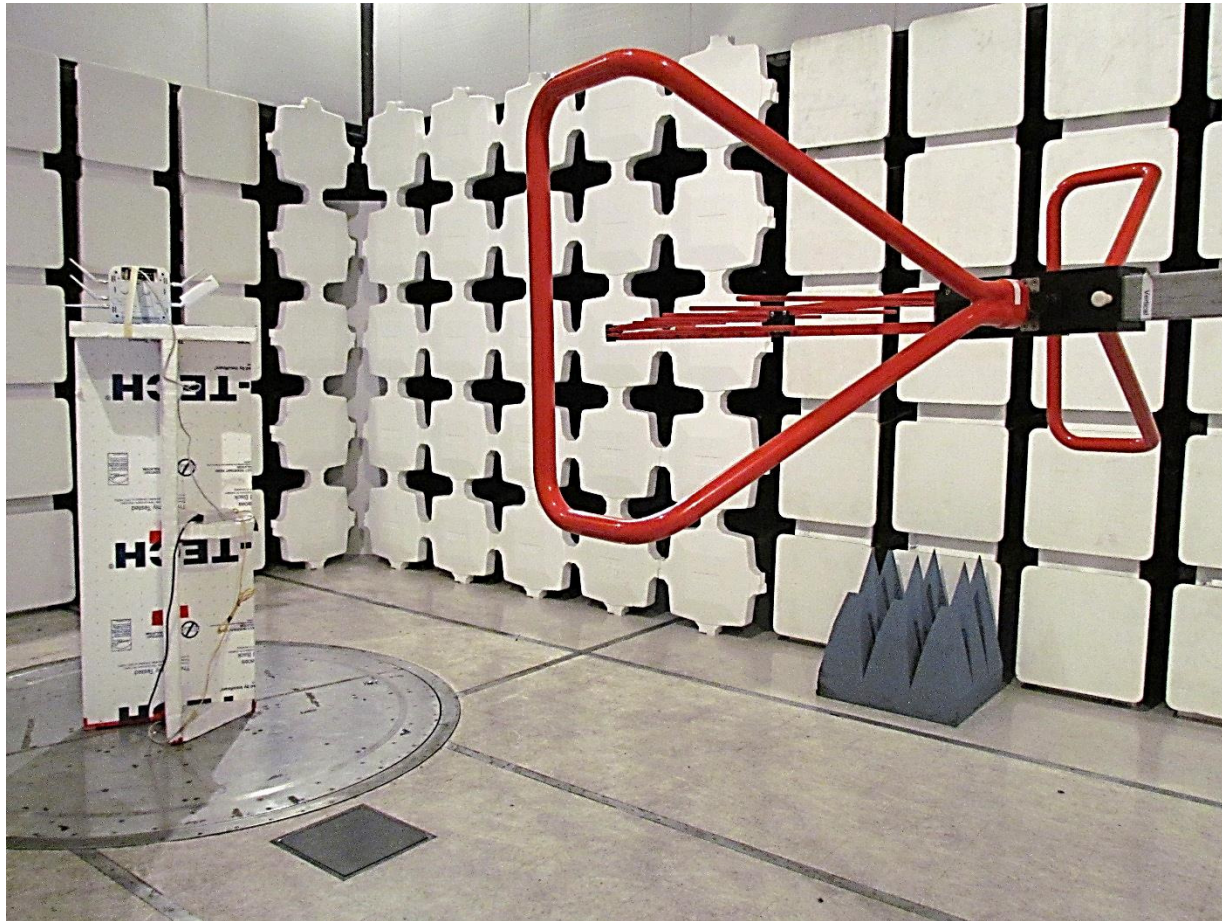

This test report may be reproduced in full only. The document may only be updated by MiCOM Labs personnel. Any changes will be noted in the Document History section of the report.

Radiated Emissions above 1GHz

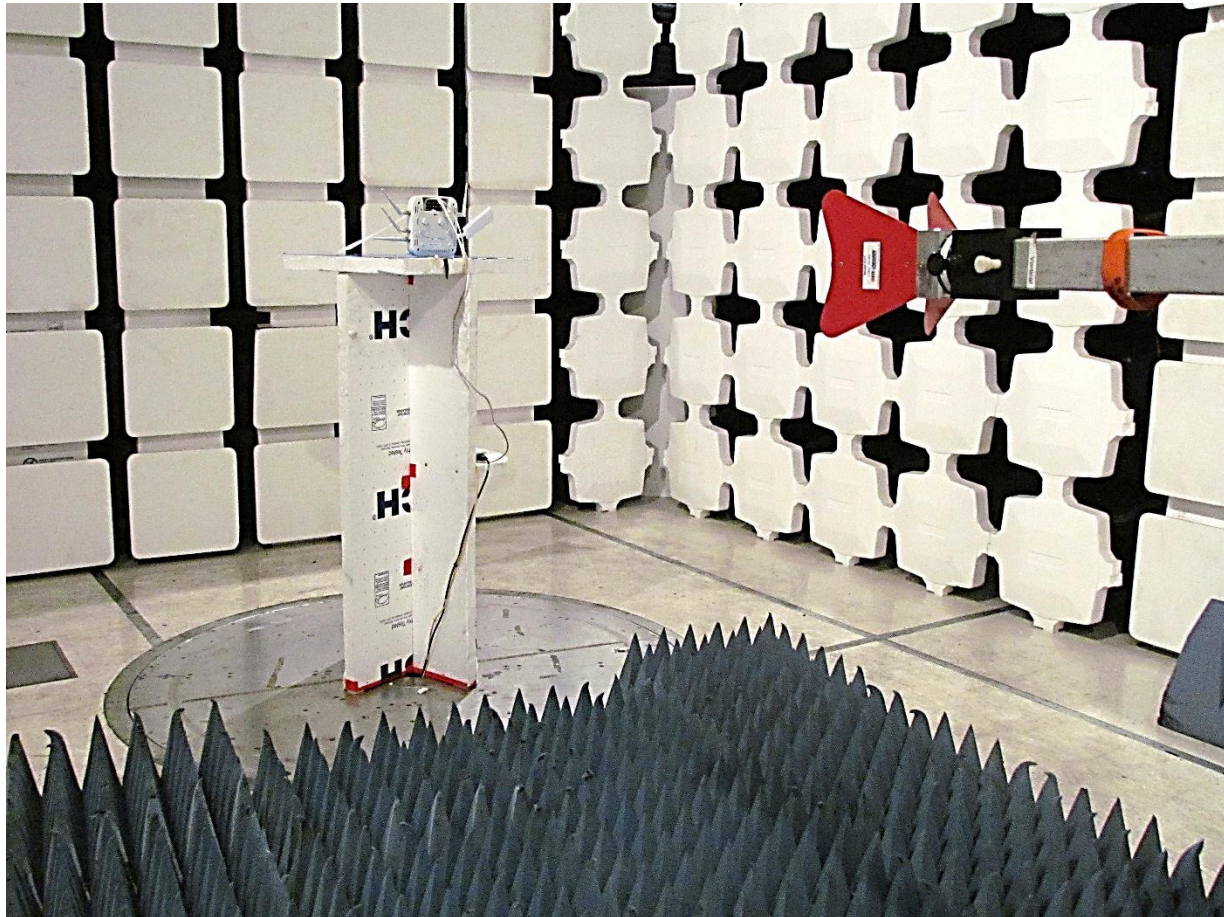

This test report may be reproduced in full only. The document may only be updated by MiCOM Labs personnel. Any changes will be noted in the Document History section of the report.



Title: NetScout Systems Inc. SENSOR4 Product Family
To: FCC CFR 47 Part 15 Subpart E 15.407 & IC RSS-247
Serial #: NTCT77-U4 Rev B
Issue Date: 12th December 2016
Page: 71 of 128

A. APPENDIX - GRAPHICAL IMAGES

This test report may be reproduced in full only. The document may only be updated by MiCOM Labs personnel. Any changes will be noted in the Document History section of the report.



A.1. 6 dB & 99% Bandwidth

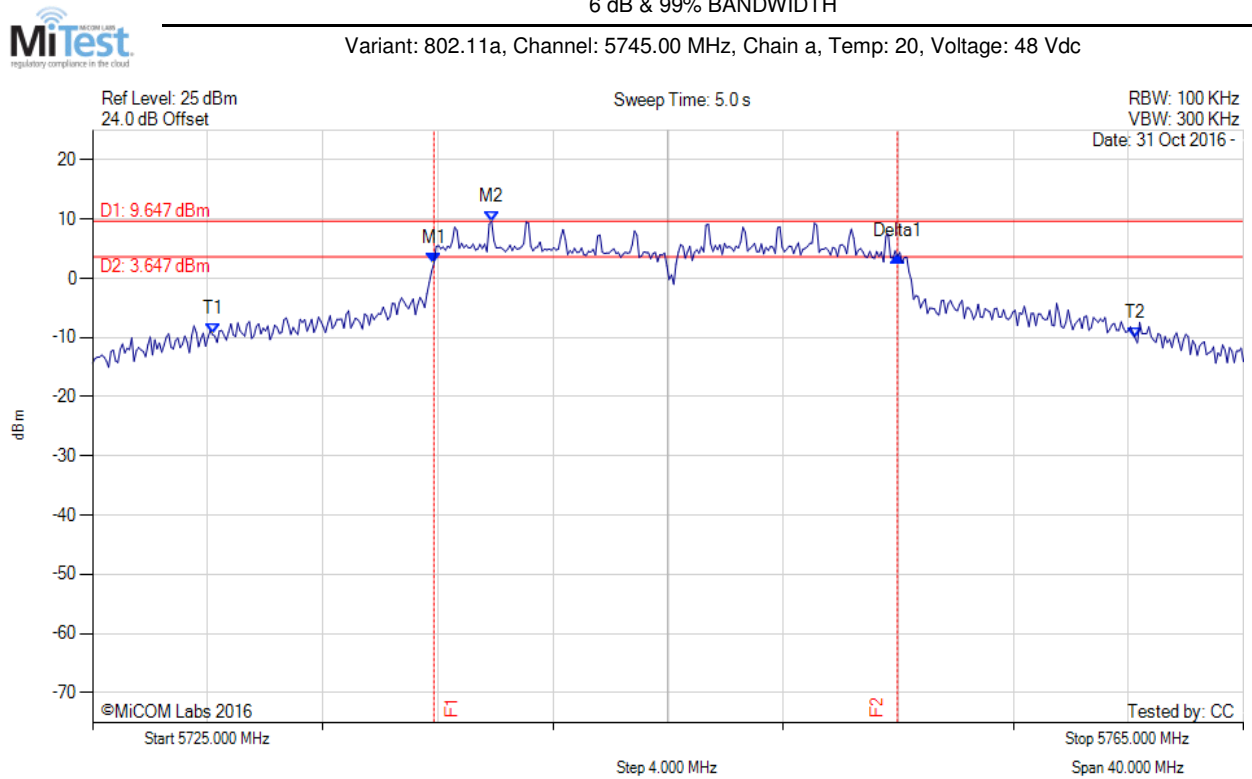

Analyzer Setup	Marker:Frequency:Amplitude	Test Results
Detector = MAX PEAK Sweep Count = 0 RF Atten (dB) = 20 Trace Mode = MAX HOLD	M1 : 5736.864 MHz : 2.505 dBm M2 : 5738.868 MHz : 9.647 dBm Delta1 : 16.112 MHz : 1.279 dB T1 : 5729.168 MHz : -9.472 dBm T2 : 5761.232 MHz : -10.080 dBm OBW : 32.064 MHz	Measured 26 dB Bandwidth: 16.112 MHz Measured 99% Bandwidth: 32.064 MHz

[back to matrix](#)

This test report may be reproduced in full only. The document may only be updated by MiCOM Labs personnel. Any changes will be noted in the Document History section of the report.



6 dB & 99% BANDWIDTH

Variante: 802.11a, Channel: 5745.00 MHz, Chain b, Temp: 20, Voltage: 48 Vdc

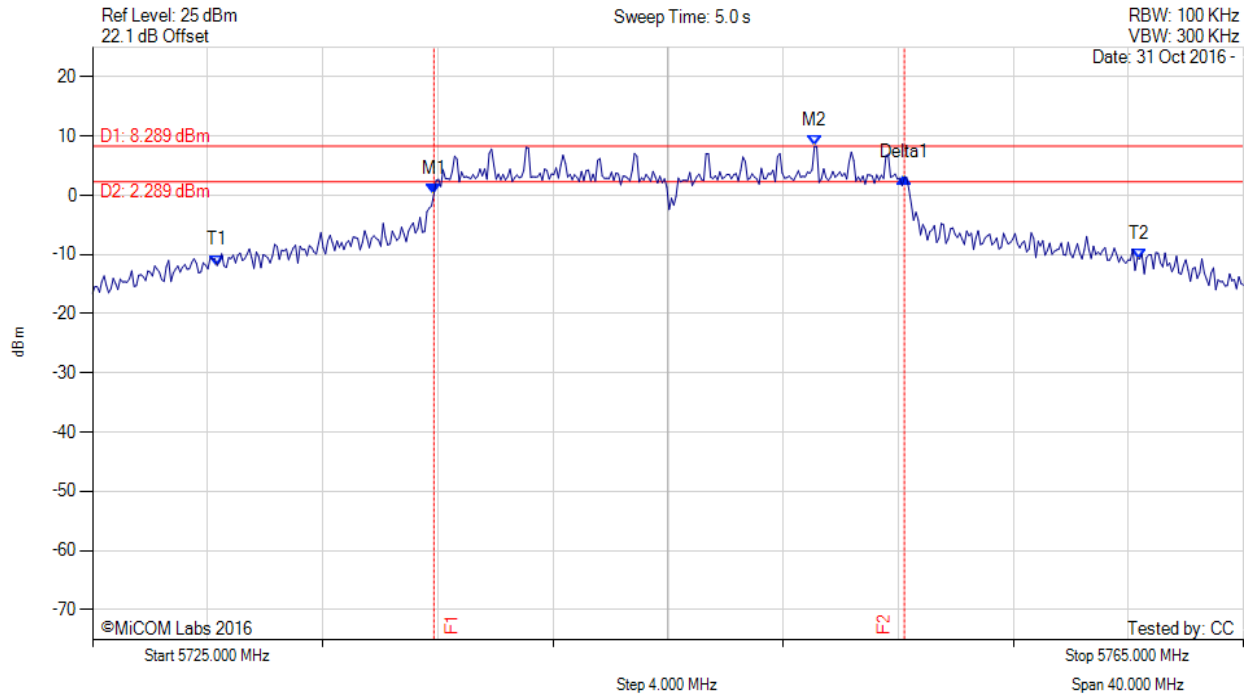

Analyzer Setup	Marker:Frequency:Amplitude	Test Results
Detector = MAX PEAK Sweep Count = 0 RF Atten (dB) = 20 Trace Mode = MAX HOLD	M1 : 5736.864 MHz : 0.245 dBm M2 : 5750.090 MHz : 8.289 dBm Delta1 : 16.353 MHz : 2.741 dB T1 : 5729.329 MHz : -11.849 dBm T2 : 5761.393 MHz : -10.755 dBm OBW : 32.064 MHz	Measured 26 dB Bandwidth: 16.353 MHz Measured 99% Bandwidth: 32.064 MHz

[back to matrix](#)

This test report may be reproduced in full only. The document may only be updated by MiCOM Labs personnel. Any changes will be noted in the Document History section of the report.



Title: NetScout Systems Inc. SENSOR4 Product Family
To: FCC CFR 47 Part 15 Subpart E 15.407 & IC RSS-247
Serial #: NTCT77-U4 Rev B
Issue Date: 12th December 2016
Page: 74 of 128



6 dB & 99% BANDWIDTH

Variant: 802.11a, Channel: 5745.00 MHz, Chain c, Temp: 20, Voltage: 48 Vdc

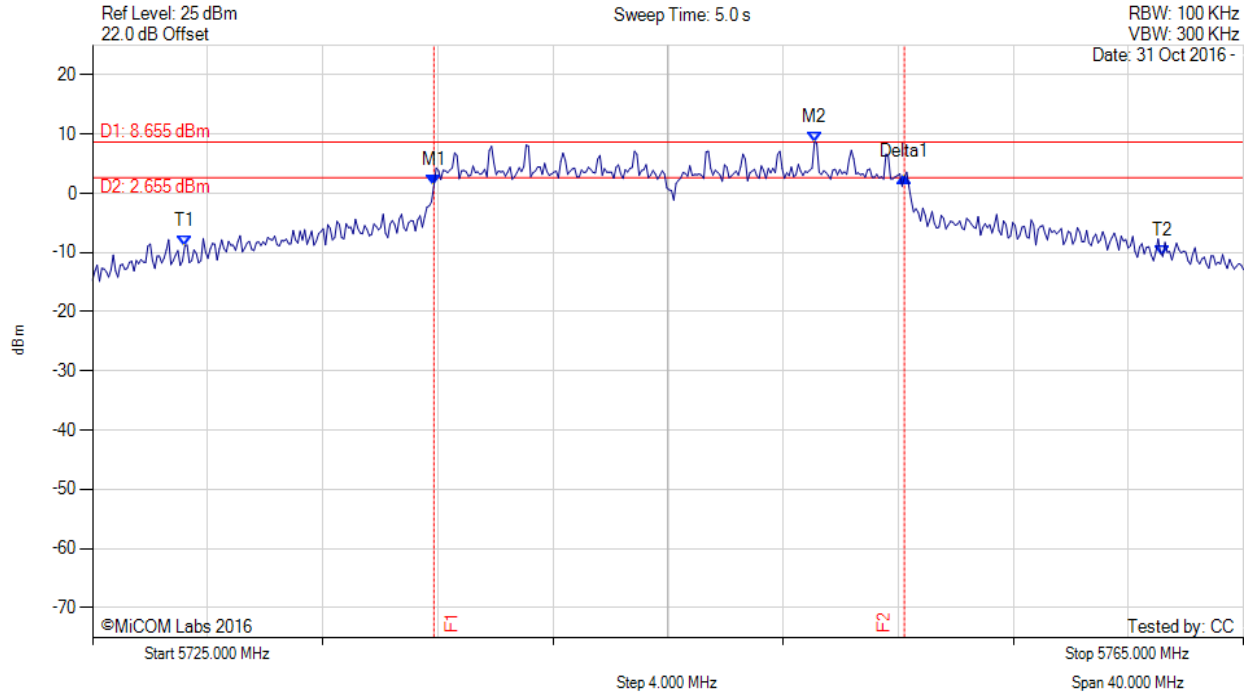

Analyzer Setup	Marker:Frequency:Amplitude	Test Results
Detector = MAX PEAK Sweep Count = 0 RF Atten (dB) = 20 Trace Mode = MAX HOLD	M1 : 5736.864 MHz : 1.364 dBm M2 : 5750.090 MHz : 8.655 dBm Delta1 : 16.353 MHz : 1.324 dB T1 : 5728.206 MHz : -8.878 dBm T2 : 5762.194 MHz : -10.654 dBm OBW : 33.988 MHz	Measured 26 dB Bandwidth: 16.353 MHz Measured 99% Bandwidth: 33.988 MHz

[back to matrix](#)

This test report may be reproduced in full only. The document may only be updated by MiCOM Labs personnel. Any changes will be noted in the Document History section of the report.



Title: NetScout Systems Inc. SENSOR4 Product Family
To: FCC CFR 47 Part 15 Subpart E 15.407 & IC RSS-247
Serial #: NTCT77-U4 Rev B
Issue Date: 12th December 2016
Page: 75 of 128



6 dB & 99% BANDWIDTH

Variant: 802.11a, Channel: 5785.00 MHz, Chain a, Temp: 20, Voltage: 48 Vdc

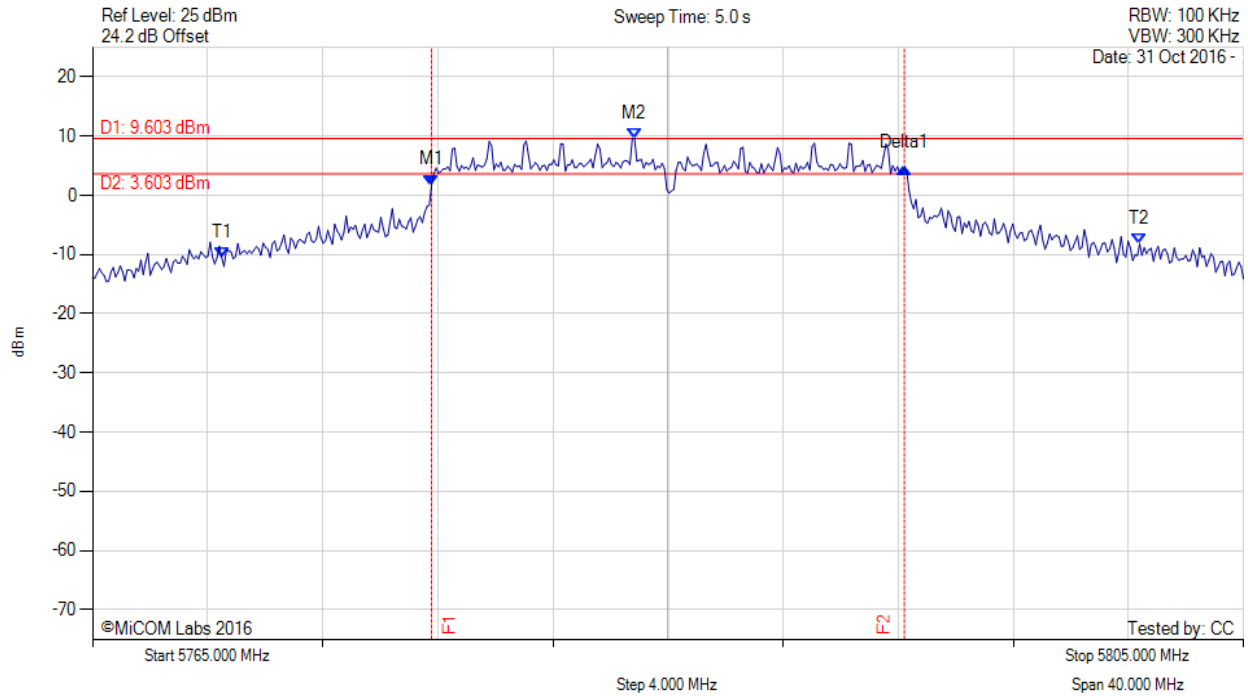

Analyzer Setup	Marker:Frequency:Amplitude	Test Results
Detector = MAX PEAK Sweep Count = 0 RF Atten (dB) = 20 Trace Mode = MAX HOLD	M1 : 5776.784 MHz : 1.730 dBm M2 : 5783.838 MHz : 9.603 dBm Delta1 : 16.433 MHz : 2.961 dB T1 : 5769.489 MHz : -10.525 dBm T2 : 5801.393 MHz : -8.209 dBm OBW : 31.904 MHz	Measured 26 dB Bandwidth: 16.433 MHz Measured 99% Bandwidth: 31.904 MHz

[back to matrix](#)

This test report may be reproduced in full only. The document may only be updated by MiCOM Labs personnel. Any changes will be noted in the Document History section of the report.



6 dB & 99% BANDWIDTH

Variants: 802.11a, Channel: 5785.00 MHz, Chain b, Temp: 20, Voltage: 48 Vdc

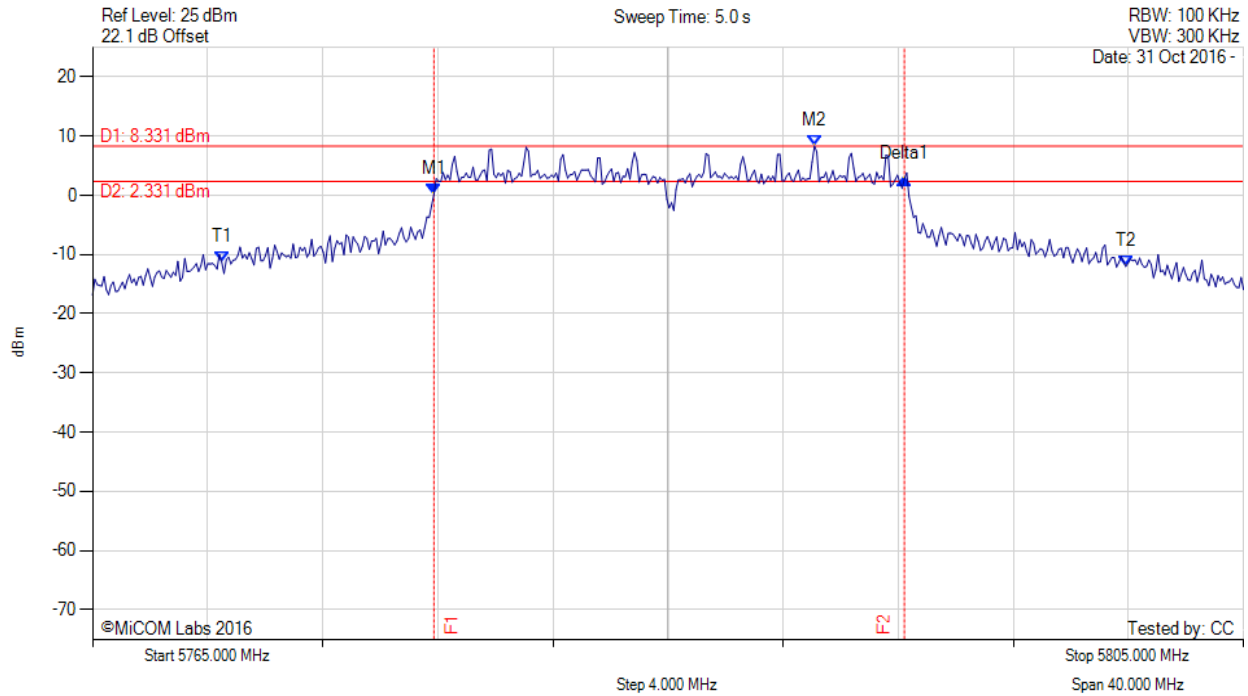

Analyzer Setup	Marker:Frequency:Amplitude	Test Results
Detector = MAX PEAK Sweep Count = 0 RF Atten (dB) = 20 Trace Mode = MAX HOLD	M1 : 5776.864 MHz : 0.150 dBm M2 : 5790.090 MHz : 8.331 dBm Delta1 : 16.353 MHz : 2.634 dB T1 : 5769.489 MHz : -11.258 dBm T2 : 5800.912 MHz : -12.002 dBm OBW : 31.423 MHz	Measured 26 dB Bandwidth: 16.353 MHz Measured 99% Bandwidth: 31.423 MHz

[back to matrix](#)

This test report may be reproduced in full only. The document may only be updated by MiCOM Labs personnel. Any changes will be noted in the Document History section of the report.



6 dB & 99% BANDWIDTH

Variant: 802.11a, Channel: 5785.00 MHz, Chain c, Temp: 20, Voltage: 48 Vdc

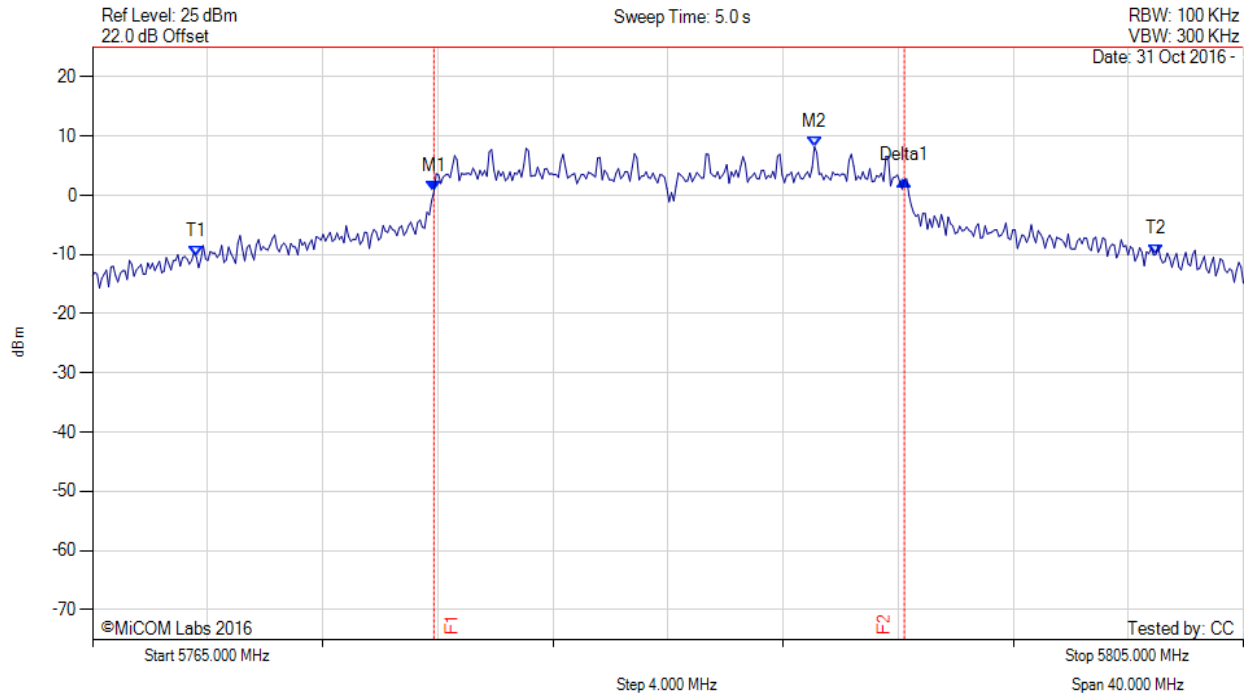

Analyzer Setup	Marker:Frequency:Amplitude	Test Results
Detector = MAX PEAK Sweep Count = 0 RF Atten (dB) = 20 Trace Mode = MAX HOLD	M1 : 5776.864 MHz : 0.591 dBm M2 : 5790.090 MHz : 8.218 dBm Delta1 : 16.353 MHz : 1.969 dB T1 : 5768.607 MHz : -10.403 dBm T2 : 5801.954 MHz : -9.964 dBm OBW : 33.347 MHz	Measured 26 dB Bandwidth: 16.353 MHz Measured 99% Bandwidth: 33.347 MHz

[back to matrix](#)

This test report may be reproduced in full only. The document may only be updated by MiCOM Labs personnel. Any changes will be noted in the Document History section of the report.



Title: NetScout Systems Inc. SENSOR4 Product Family
To: FCC CFR 47 Part 15 Subpart E 15.407 & IC RSS-247
Serial #: NTCT77-U4 Rev B
Issue Date: 12th December 2016
Page: 78 of 128



6 dB & 99% BANDWIDTH

Variants: 802.11a, Channel: 5825.00 MHz, Chain a, Temp: 20, Voltage: 48 Vdc

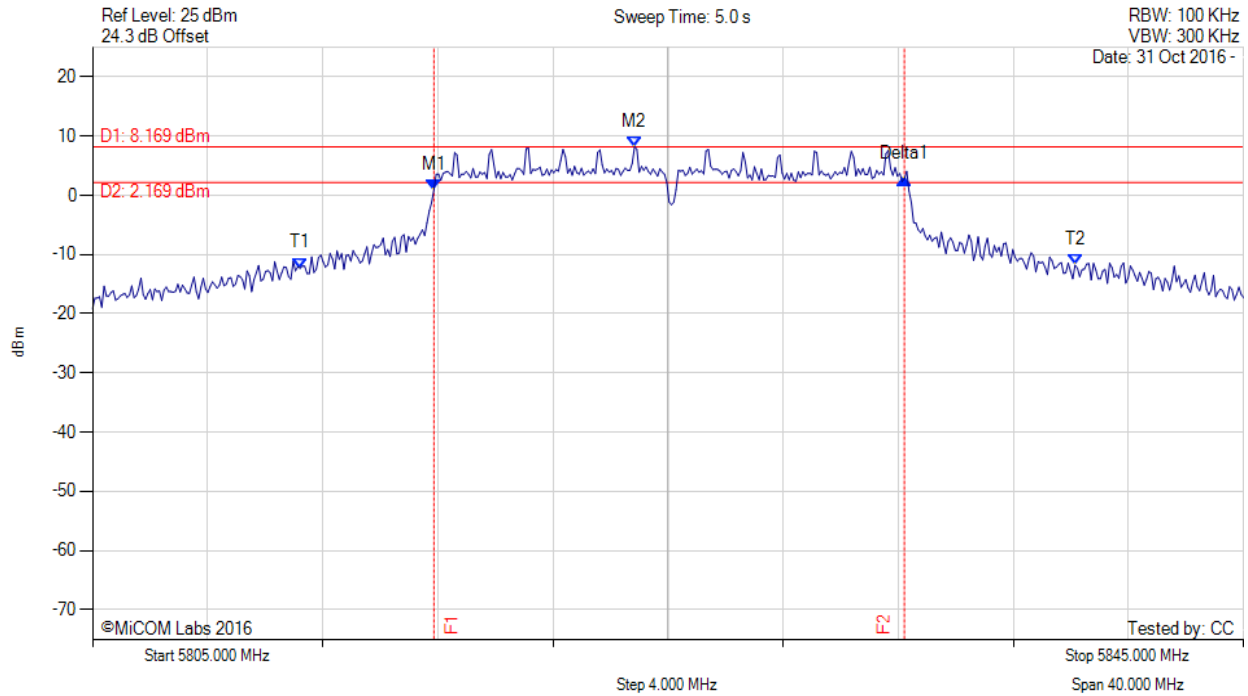

Analyzer Setup	Marker:Frequency:Amplitude	Test Results
Detector = MAX PEAK Sweep Count = 0 RF Atten (dB) = 20 Trace Mode = MAX HOLD	M1 : 5816.864 MHz : 0.939 dBm M2 : 5823.838 MHz : 8.169 dBm Delta1 : 16.353 MHz : 1.824 dB T1 : 5812.214 MHz : -12.295 dBm T2 : 5839.148 MHz : -11.784 dBm OBW : 26.934 MHz	Measured 26 dB Bandwidth: 16.353 MHz Measured 99% Bandwidth: 26.934 MHz

[back to matrix](#)

This test report may be reproduced in full only. The document may only be updated by MiCOM Labs personnel. Any changes will be noted in the Document History section of the report.



6 dB & 99% BANDWIDTH

Variant: 802.11a, Channel: 5825.00 MHz, Chain b, Temp: 20, Voltage: 48 Vdc

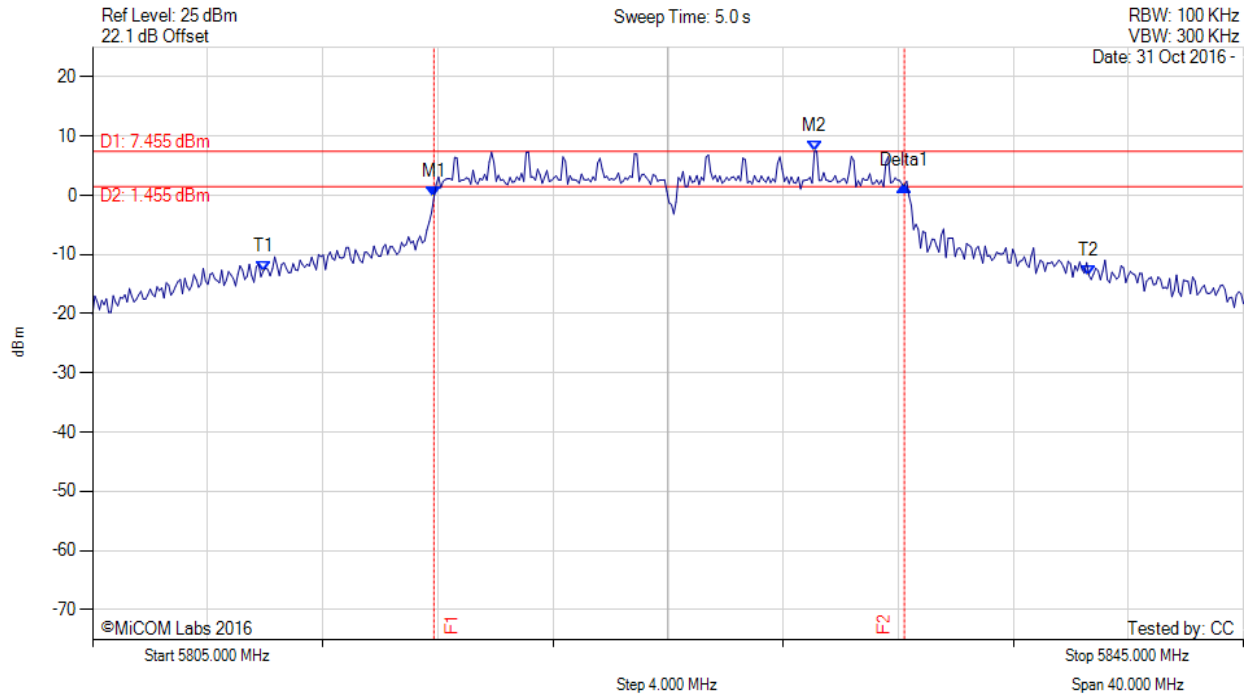

Analyzer Setup	Marker:Frequency:Amplitude	Test Results
Detector = MAX PEAK Sweep Count = 0 RF Atten (dB) = 20 Trace Mode = MAX HOLD	M1 : 5816.864 MHz : -0.357 dBm M2 : 5830.090 MHz : 7.455 dBm Delta1 : 16.353 MHz : 2.017 dB T1 : 5810.932 MHz : -12.805 dBm T2 : 5839.629 MHz : -13.542 dBm OBW : 28.697 MHz	Measured 26 dB Bandwidth: 16.353 MHz Measured 99% Bandwidth: 28.697 MHz

[back to matrix](#)

This test report may be reproduced in full only. The document may only be updated by MiCOM Labs personnel. Any changes will be noted in the Document History section of the report.



Title: NetScout Systems Inc. SENSOR4 Product Family
To: FCC CFR 47 Part 15 Subpart E 15.407 & IC RSS-247
Serial #: NTCT77-U4 Rev B
Issue Date: 12th December 2016
Page: 80 of 128



6 dB & 99% BANDWIDTH

Variant: 802.11a, Channel: 5825.00 MHz, Chain c, Temp: 20, Voltage: 48 Vdc

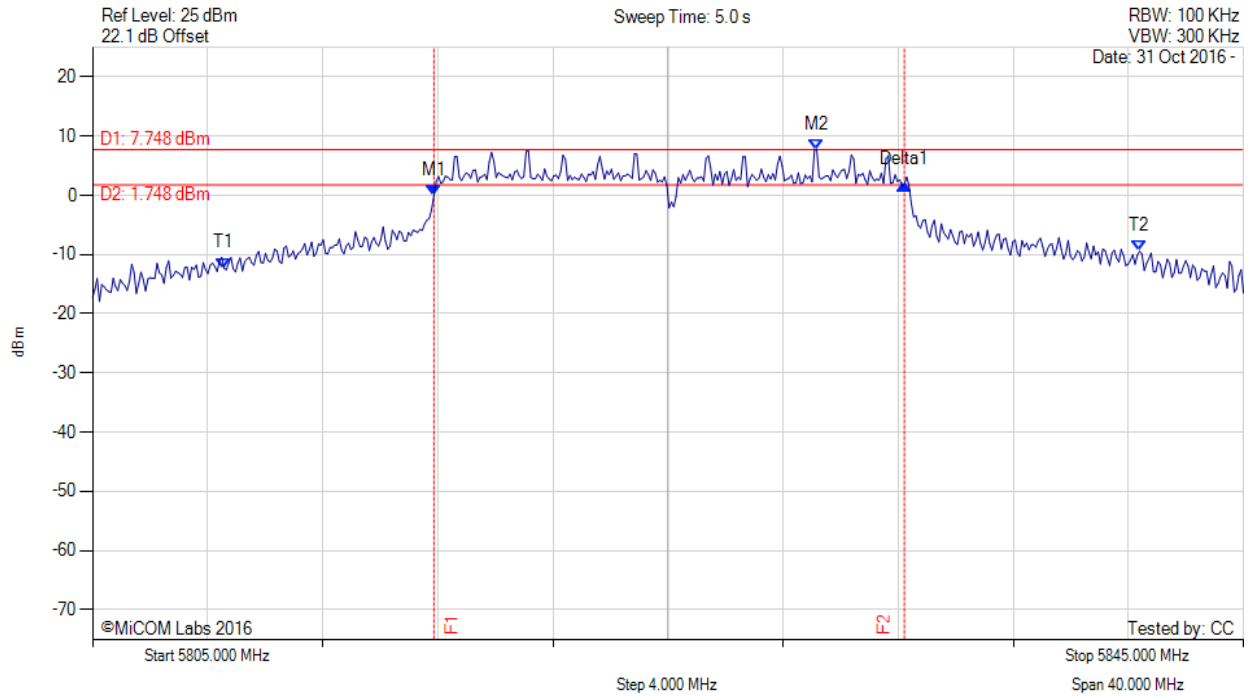

Analyzer Setup	Marker:Frequency:Amplitude	Test Results
Detector = MAX PEAK Sweep Count = 0 RF Atten (dB) = 20 Trace Mode = MAX HOLD	M1 : 5816.864 MHz : -0.090 dBm M2 : 5830.170 MHz : 7.748 dBm Delta1 : 16.353 MHz : 1.967 dB T1 : 5809.569 MHz : -12.293 dBm T2 : 5841.393 MHz : -9.439 dBm OBW : 31.824 MHz	Measured 26 dB Bandwidth: 16.353 MHz Measured 99% Bandwidth: 31.824 MHz

[back to matrix](#)

This test report may be reproduced in full only. The document may only be updated by MiCOM Labs personnel. Any changes will be noted in the Document History section of the report.



6 dB & 99% BANDWIDTH

Variants: 802.11n HT-20, Channel: 5745.00 MHz, Chain a, Temp: 20, Voltage: 48 Vdc

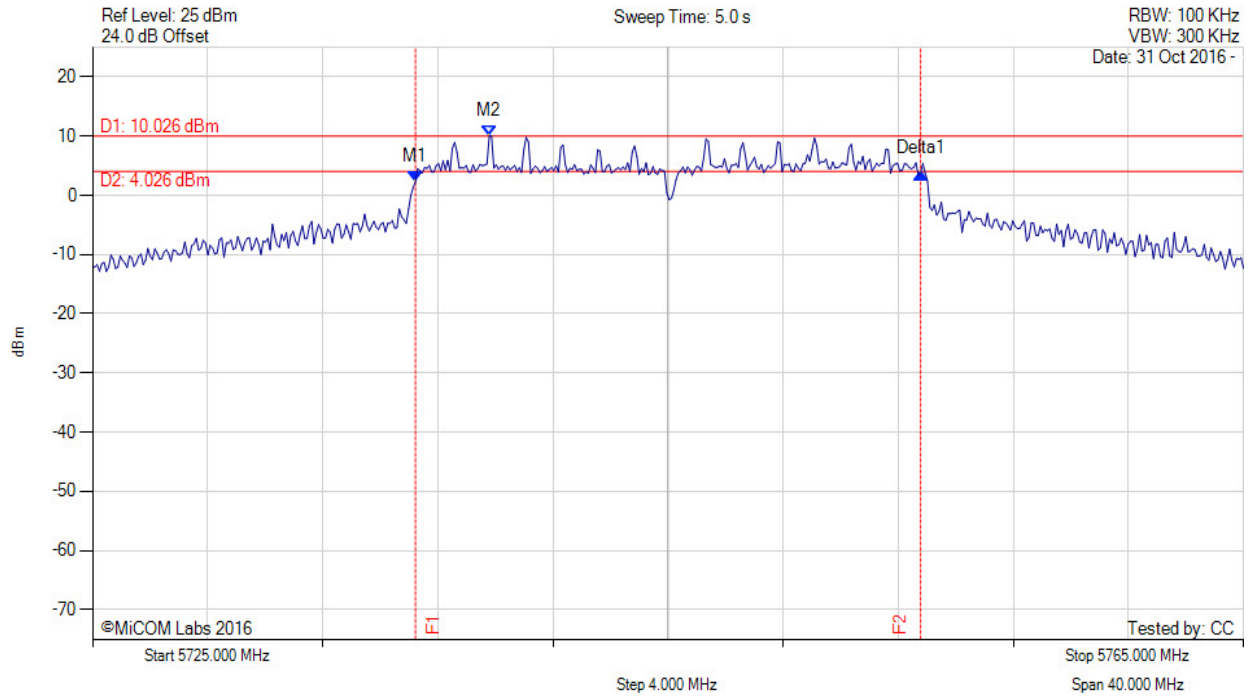

Analyzer Setup	Marker:Frequency:Amplitude	Test Results
Detector = MAX PEAK Sweep Count = 0 RF Atten (dB) = 20 Trace Mode = MAX HOLD	M1 : 5736.222 MHz : 2.287 dBm M2 : 5738.788 MHz : 10.026 dBm Delta1 : 17.555 MHz : 1.428 dB T1 : 0 Hz : 500.000 dBm T2 : 0 Hz : 500.000 dBm OBW : 33.427 MHz	Measured 26 dB Bandwidth: 17.555 MHz Measured 99% Bandwidth: 33.427 MHz

[back to matrix](#)

This test report may be reproduced in full only. The document may only be updated by MiCOM Labs personnel. Any changes will be noted in the Document History section of the report.



6 dB & 99% BANDWIDTH

Variante: 802.11n HT-20, Channel: 5745.00 MHz, Chain b, Temp: 20, Voltage: 48 Vdc

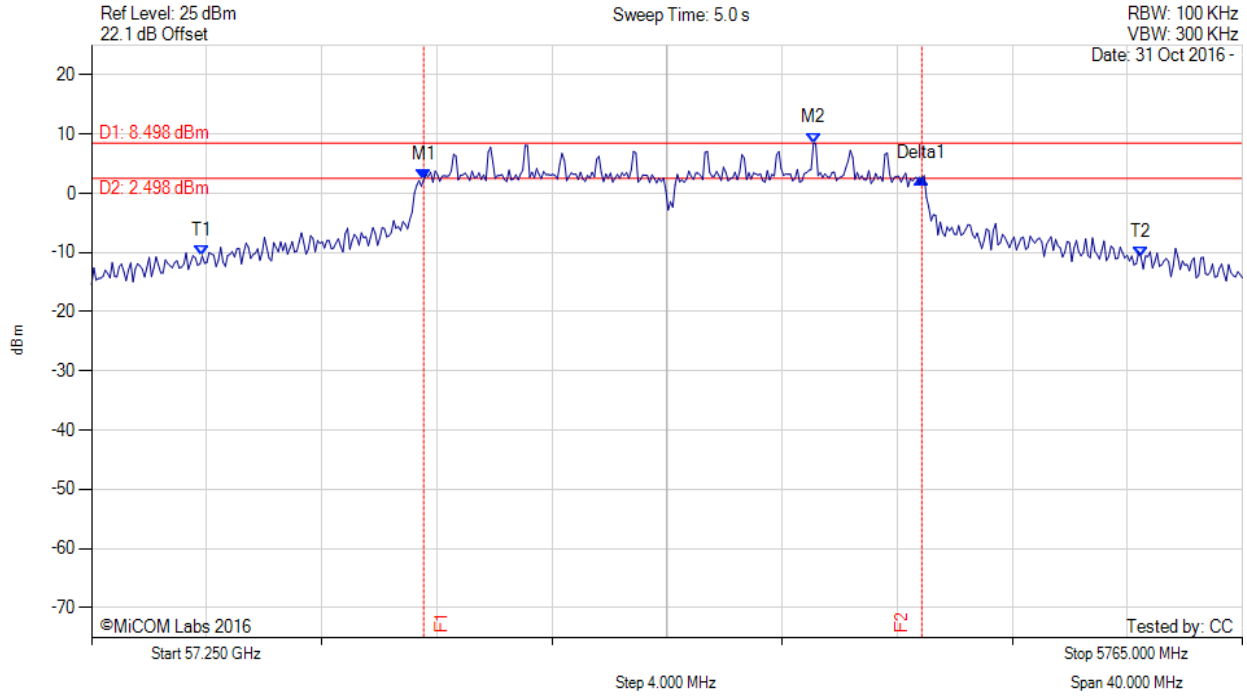

Analyzer Setup	Marker:Frequency:Amplitude	Test Results
Detector = MAX PEAK Sweep Count = 0 RF Atten (dB) = 20 Trace Mode = MAX HOLD	M1 : 5736.543 MHz : 2.287 dBm M2 : 5750.090 MHz : 8.498 dBm Delta1 : 17.315 MHz : 0.226 dB T1 : 5728.848 MHz : -10.580 dBm T2 : 5761.473 MHz : -10.721 dBm OBW : 32.625 MHz	Measured 26 dB Bandwidth: 17.315 MHz Measured 99% Bandwidth: 32.625 MHz

[back to matrix](#)

This test report may be reproduced in full only. The document may only be updated by MiCOM Labs personnel. Any changes will be noted in the Document History section of the report.



Title: NetScout Systems Inc. SENSOR4 Product Family
To: FCC CFR 47 Part 15 Subpart E 15.407 & IC RSS-247
Serial #: NTCT77-U4 Rev B
Issue Date: 12th December 2016
Page: 83 of 128



6 dB & 99% BANDWIDTH

Variant: 802.11n HT-20, Channel: 5745.00 MHz, Chain c, Temp: 20, Voltage: 48 Vdc

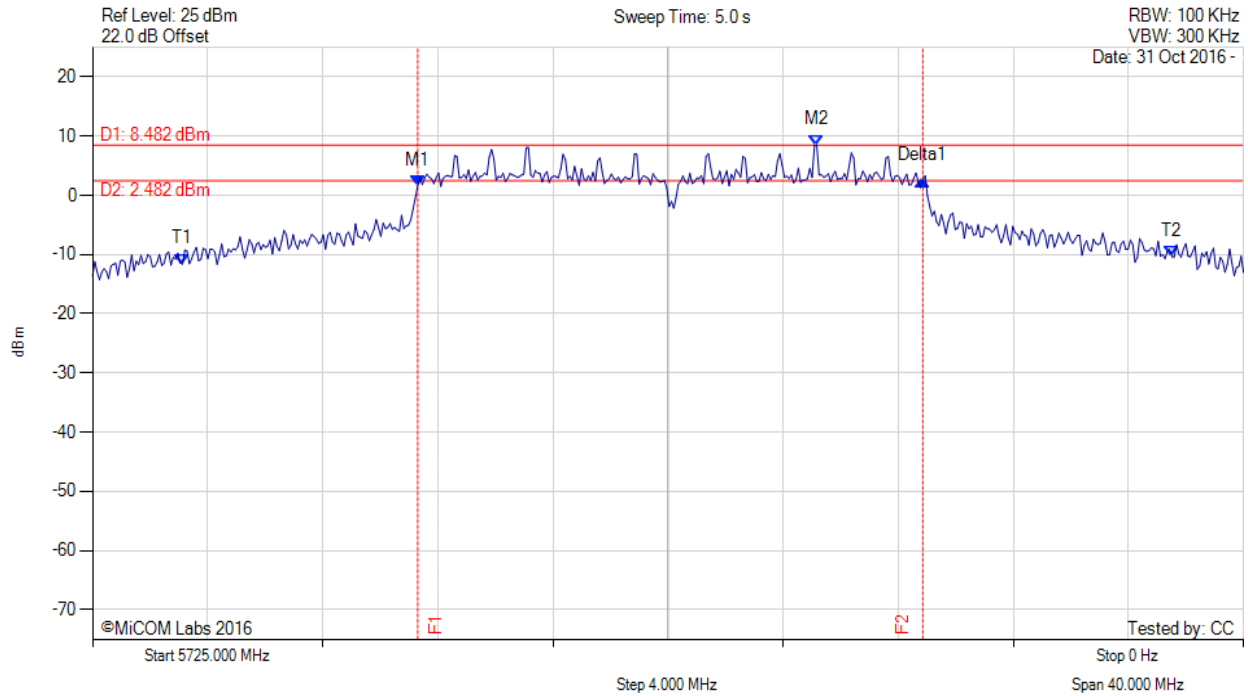

Analyzer Setup	Marker:Frequency:Amplitude	Test Results
Detector = MAX PEAK Sweep Count = 0 RF Atten (dB) = 20 Trace Mode = MAX HOLD	M1 : 5736.303 MHz : 1.663 dBm M2 : 5750.170 MHz : 8.482 dBm Delta1 : 17.555 MHz : 0.911 dB T1 : 5728.126 MHz : -11.603 dBm T2 : 5762.515 MHz : -10.369 dBm OBW : 34.389 MHz	Measured 26 dB Bandwidth: 17.555 MHz Measured 99% Bandwidth: 34.389 MHz

[back to matrix](#)

This test report may be reproduced in full only. The document may only be updated by MiCOM Labs personnel. Any changes will be noted in the Document History section of the report.



6 dB & 99% BANDWIDTH

Variants: 802.11n HT-20, Channel: 5785.00 MHz, Chain a, Temp: 20, Voltage: 48 Vdc

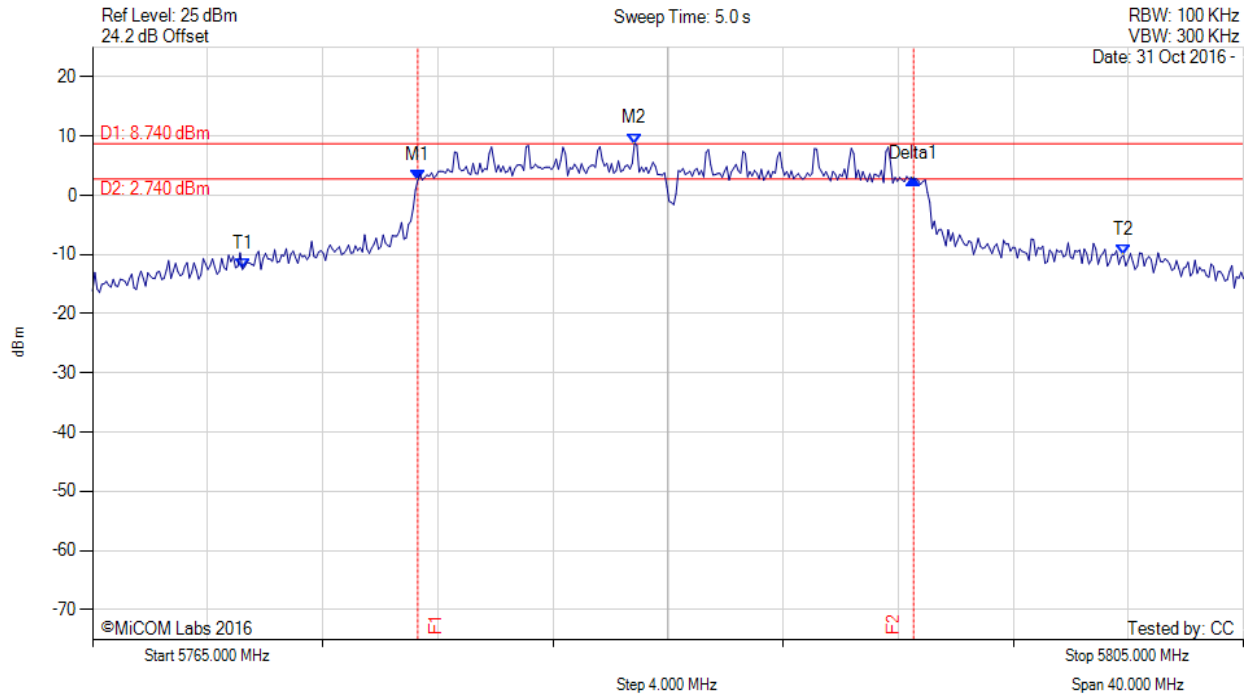

Analyzer Setup	Marker:Frequency:Amplitude	Test Results
Detector = MAX PEAK Sweep Count = 0 RF Atten (dB) = 20 Trace Mode = MAX HOLD	M1 : 5776.303 MHz : 2.501 dBm M2 : 5783.838 MHz : 8.740 dBm Delta1 : 17.234 MHz : 0.242 dB T1 : 5770.210 MHz : -12.504 dBm T2 : 5800.832 MHz : -10.135 dBm OBW : 30.621 MHz	Measured 26 dB Bandwidth: 17.234 MHz Measured 99% Bandwidth: 30.621 MHz

[back to matrix](#)

This test report may be reproduced in full only. The document may only be updated by MiCOM Labs personnel. Any changes will be noted in the Document History section of the report.



6 dB & 99% BANDWIDTH

Variant: 802.11n HT-20, Channel: 5785.00 MHz, Chain b, Temp: 20, Voltage: 48 Vdc

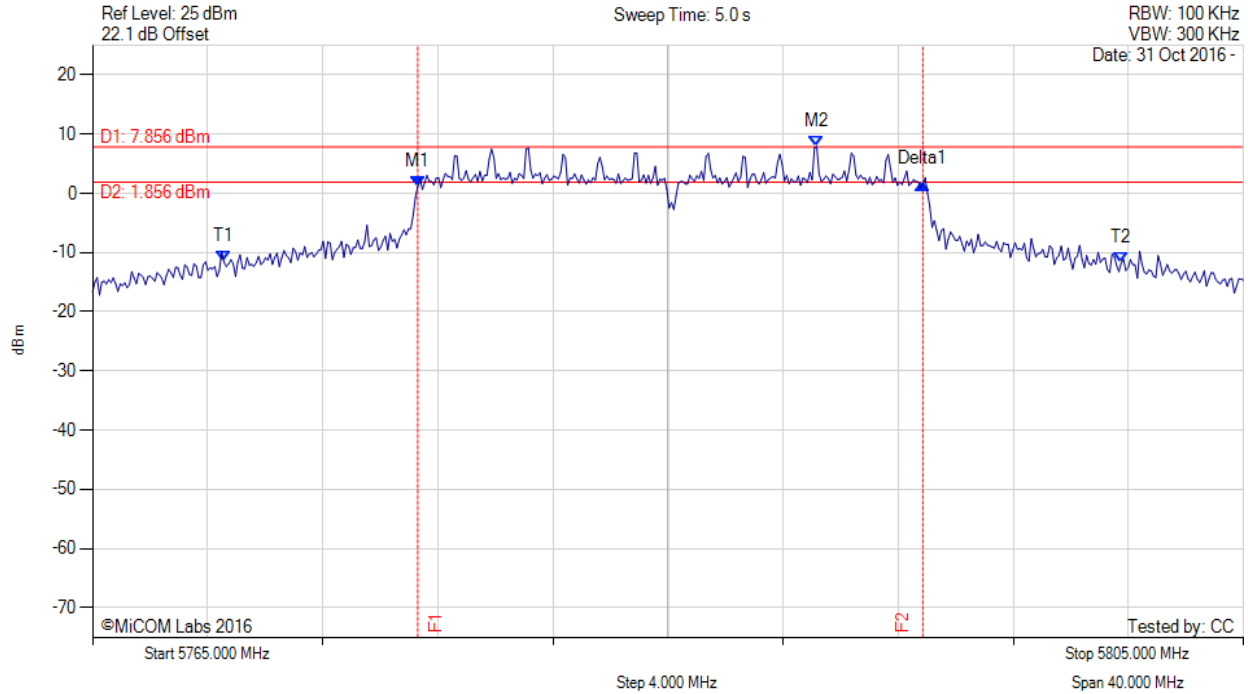

Analyzer Setup	Marker:Frequency:Amplitude	Test Results
Detector = MAX PEAK Sweep Count = 0 RF Atten (dB) = 20 Trace Mode = MAX HOLD	M1 : 5776.303 MHz : 1.136 dBm M2 : 5790.170 MHz : 7.856 dBm Delta1 : 17.555 MHz : 0.380 dB T1 : 5769.569 MHz : -11.587 dBm T2 : 5800.752 MHz : -11.782 dBm OBW : 31.182 MHz	Measured 26 dB Bandwidth: 17.555 MHz Measured 99% Bandwidth: 31.182 MHz

[back to matrix](#)

This test report may be reproduced in full only. The document may only be updated by MiCOM Labs personnel. Any changes will be noted in the Document History section of the report.



6 dB & 99% BANDWIDTH

Variant: 802.11n HT-20, Channel: 5785.00 MHz, Chain c, Temp: 20, Voltage: 48 Vdc

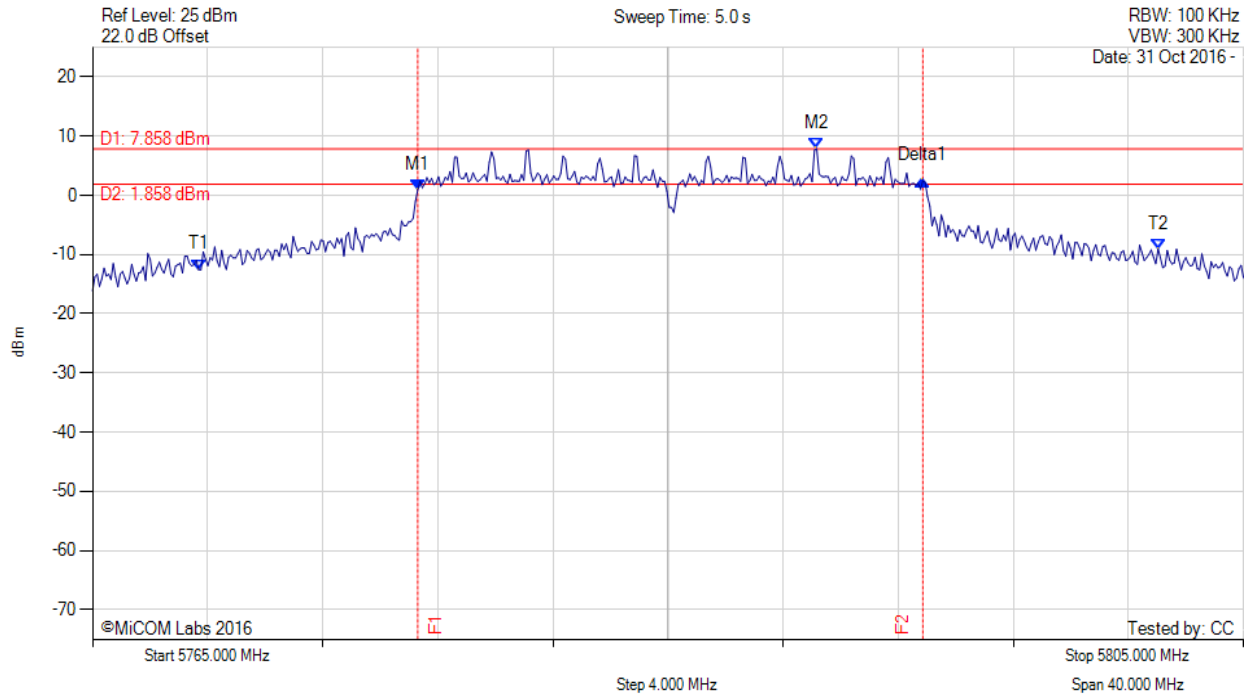

Analyzer Setup	Marker:Frequency:Amplitude	Test Results
Detector = MAX PEAK Sweep Count = 0 RF Atten (dB) = 20 Trace Mode = MAX HOLD	M1 : 5776.303 MHz : 0.943 dBm M2 : 5790.170 MHz : 7.858 dBm Delta1 : 17.555 MHz : 1.531 dB T1 : 5768.687 MHz : -12.541 dBm T2 : 5802.034 MHz : -9.051 dBm OBW : 33.347 MHz	Measured 26 dB Bandwidth: 17.555 MHz Measured 99% Bandwidth: 33.347 MHz

[back to matrix](#)

This test report may be reproduced in full only. The document may only be updated by MiCOM Labs personnel. Any changes will be noted in the Document History section of the report.



6 dB & 99% BANDWIDTH

Variant: 802.11n HT-20, Channel: 5825.00 MHz, Chain a, Temp: 20, Voltage: 48 Vdc

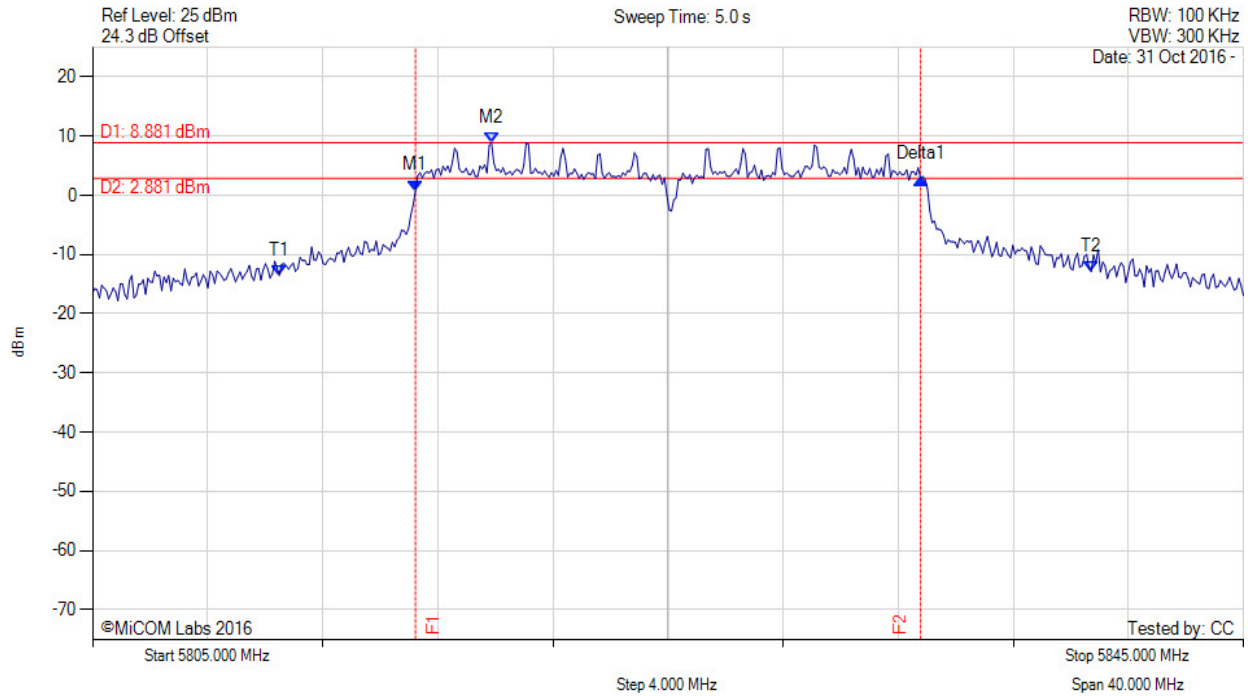

Analyzer Setup	Marker:Frequency:Amplitude	Test Results
Detector = MAX PEAK Sweep Count = 0 RF Atten (dB) = 20 Trace Mode = MAX HOLD	M1 : 5816.222 MHz : 0.784 dBm M2 : 5818.868 MHz : 8.881 dBm Delta1 : 17.555 MHz : 2.068 dB T1 : 5811.493 MHz : -13.517 dBm T2 : 5839.709 MHz : -12.876 dBm OBW : 28.216 MHz	Measured 26 dB Bandwidth: 17.555 MHz Measured 99% Bandwidth: 28.216 MHz

[back to matrix](#)

This test report may be reproduced in full only. The document may only be updated by MiCOM Labs personnel. Any changes will be noted in the Document History section of the report.



6 dB & 99% BANDWIDTH

Variant: 802.11n HT-20, Channel: 5825.00 MHz, Chain b, Temp: 20, Voltage: 48 Vdc

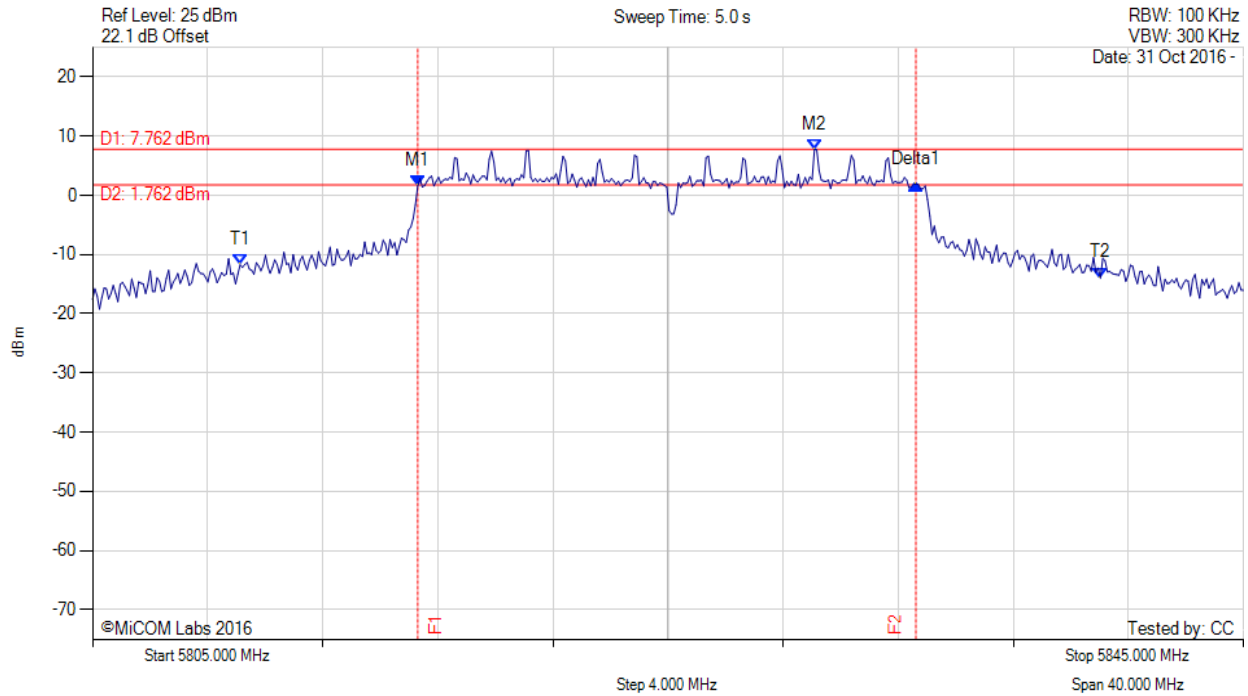

Analyzer Setup	Marker:Frequency:Amplitude	Test Results
Detector = MAX PEAK Sweep Count = 0 RF Atten (dB) = 20 Trace Mode = MAX HOLD	M1 : 5816.303 MHz : 1.557 dBm M2 : 5830.090 MHz : 7.762 dBm Delta1 : 17.315 MHz : 0.336 dB T1 : 5810.130 MHz : -11.717 dBm T2 : 5840.030 MHz : -13.942 dBm OBW : 29.900 MHz	Measured 26 dB Bandwidth: 17.315 MHz Measured 99% Bandwidth: 29.900 MHz

[back to matrix](#)

This test report may be reproduced in full only. The document may only be updated by MiCOM Labs personnel. Any changes will be noted in the Document History section of the report.



6 dB & 99% BANDWIDTH

Variant: 802.11n HT-20, Channel: 5825.00 MHz, Chain c, Temp: 20, Voltage: 48 Vdc

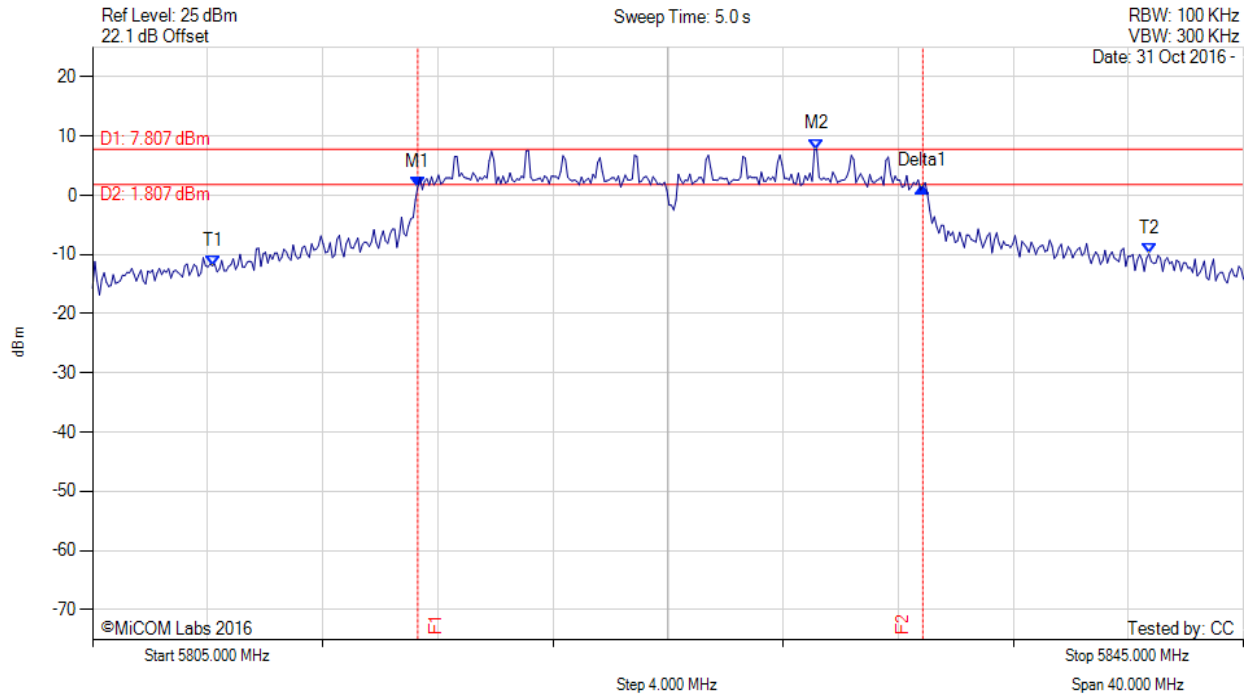

Analyzer Setup	Marker:Frequency:Amplitude	Test Results
Detector = MAX PEAK Sweep Count = 0 RF Atten (dB) = 20 Trace Mode = MAX HOLD	M1 : 5816.303 MHz : 1.451 dBm M2 : 5830.170 MHz : 7.807 dBm Delta1 : 17.555 MHz : 0.028 dB T1 : 5809.168 MHz : -11.898 dBm T2 : 5841.713 MHz : -9.885 dBm OBW : 32.545 MHz	Measured 26 dB Bandwidth: 17.555 MHz Measured 99% Bandwidth: 32.545 MHz

[back to matrix](#)

This test report may be reproduced in full only. The document may only be updated by MiCOM Labs personnel. Any changes will be noted in the Document History section of the report.



6 dB & 99% BANDWIDTH

Variants: 802.11n HT-40, Channel: 5755.00 MHz, Chain a, Temp: 20, Voltage: 48 Vdc

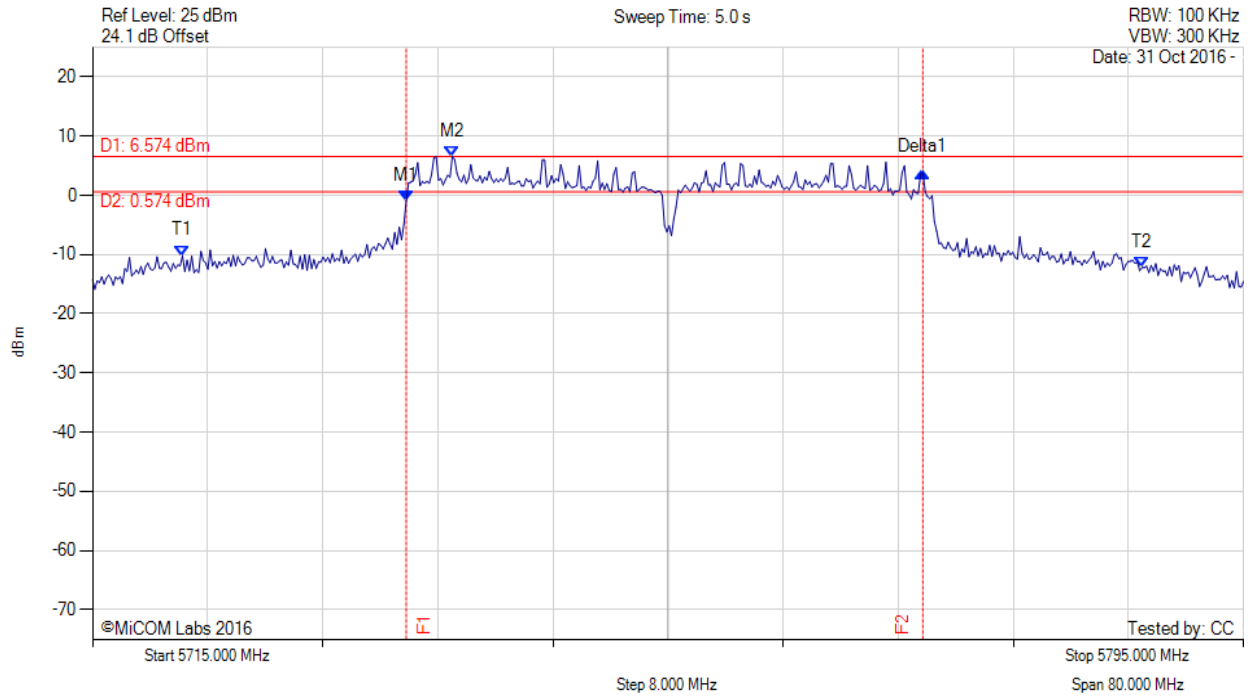

Analyzer Setup	Marker:Frequency:Amplitude	Test Results
Detector = MAX PEAK Sweep Count = 0 RF Atten (dB) = 20 Trace Mode = MAX HOLD	M1 : 5736.804 MHz : -1.012 dBm M2 : 5740.010 MHz : 6.574 dBm Delta1 : 35.912 MHz : 4.871 dB T1 : 5721.253 MHz : -10.212 dBm T2 : 5787.946 MHz : -12.209 dBm OBW : 66.693 MHz	Measured 26 dB Bandwidth: 35.912 MHz Measured 99% Bandwidth: 66.693 MHz

[back to matrix](#)

This test report may be reproduced in full only. The document may only be updated by MiCOM Labs personnel. Any changes will be noted in the Document History section of the report.



6 dB & 99% BANDWIDTH

Variante: 802.11n HT-40, Channel: 5755.00 MHz, Chain b, Temp: 20, Voltage: 48 Vdc

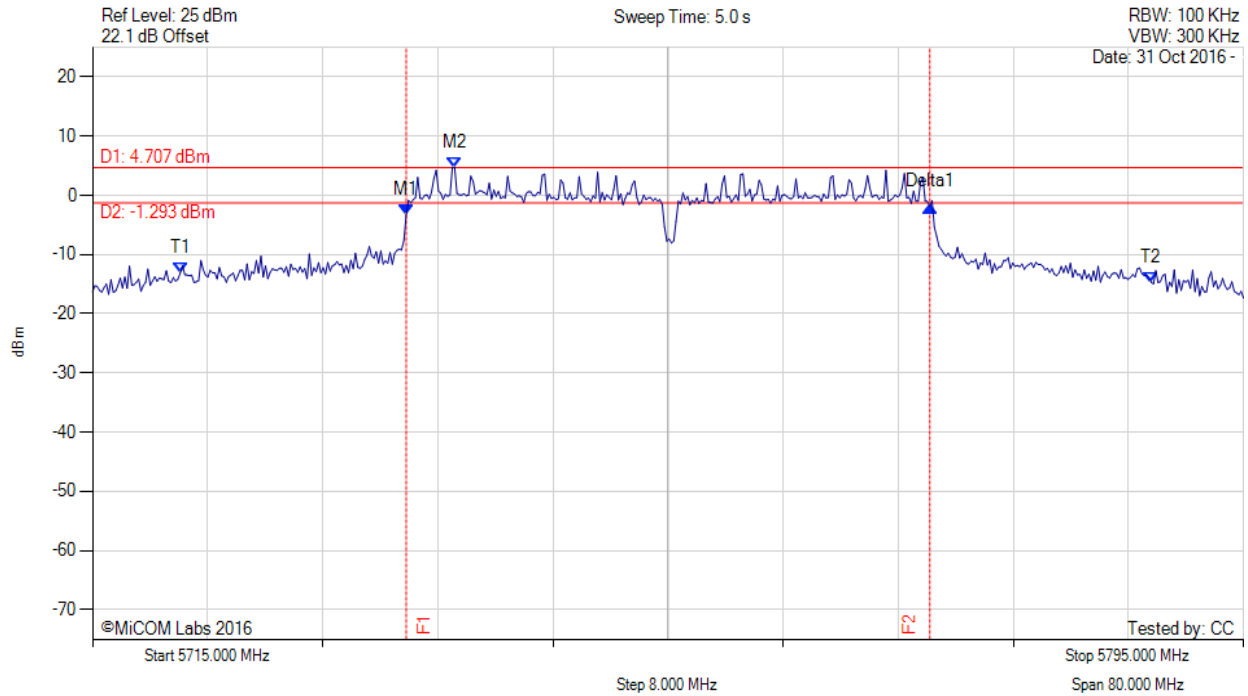

Analyzer Setup	Marker:Frequency:Amplitude	Test Results
Detector = MAX PEAK Sweep Count = 0 RF Atten (dB) = 20 Trace Mode = MAX HOLD	M1 : 5736.804 MHz : -3.273 dBm M2 : 5740.170 MHz : 4.707 dBm Delta1 : 36.393 MHz : 1.462 dB T1 : 5721.092 MHz : -13.141 dBm T2 : 5788.587 MHz : -14.672 dBm OBW : 67.495 MHz	Measured 26 dB Bandwidth: 36.393 MHz Measured 99% Bandwidth: 67.495 MHz

[back to matrix](#)

This test report may be reproduced in full only. The document may only be updated by MiCOM Labs personnel. Any changes will be noted in the Document History section of the report.



Title: NetScout Systems Inc. SENSOR4 Product Family
To: FCC CFR 47 Part 15 Subpart E 15.407 & IC RSS-247
Serial #: NTCT77-U4 Rev B
Issue Date: 12th December 2016
Page: 92 of 128



6 dB & 99% BANDWIDTH

Variant: 802.11n HT-40, Channel: 5755.00 MHz, Chain c, Temp: 20, Voltage: 48 Vdc

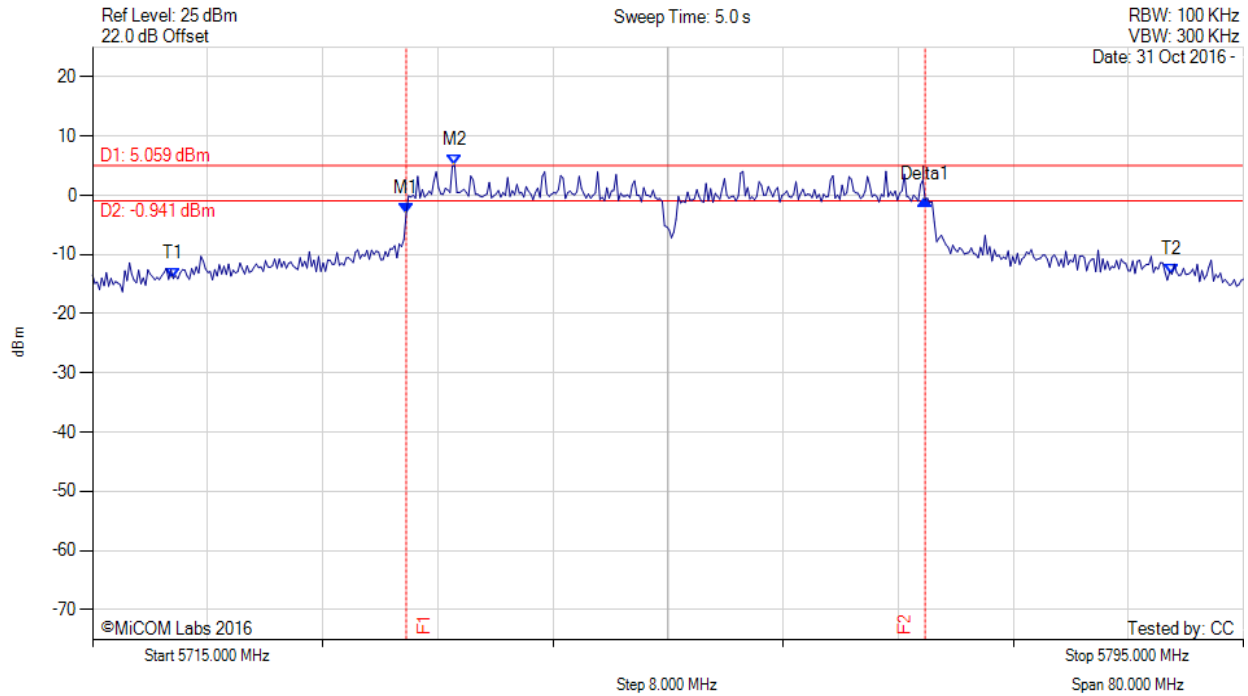

Analyzer Setup	Marker:Frequency:Amplitude	Test Results
Detector = MAX PEAK Sweep Count = 0 RF Atten (dB) = 20 Trace Mode = MAX HOLD	M1 : 5736.804 MHz : -3.143 dBm M2 : 5740.170 MHz : 5.059 dBm Delta1 : 36.072 MHz : 2.345 dB T1 : 5720.611 MHz : -14.068 dBm T2 : 5790.030 MHz : -13.338 dBm OBW : 69.419 MHz	Measured 26 dB Bandwidth: 36.072 MHz Measured 99% Bandwidth: 69.419 MHz

[back to matrix](#)

This test report may be reproduced in full only. The document may only be updated by MiCOM Labs personnel. Any changes will be noted in the Document History section of the report.



6 dB & 99% BANDWIDTH

Variante: 802.11n HT-40, Channel: 5795.00 MHz, Chain a, Temp: 20, Voltage: 48 Vdc

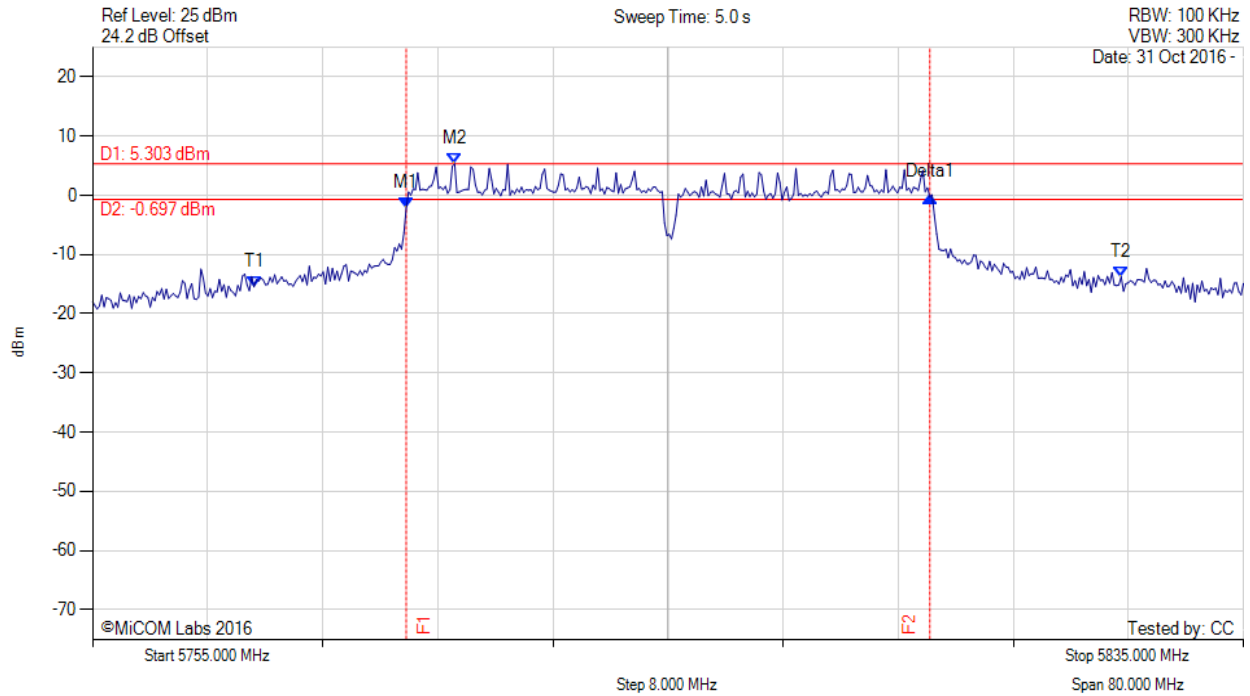

Analyzer Setup	Marker:Frequency:Amplitude	Test Results
Detector = MAX PEAK Sweep Count = 0 RF Atten (dB) = 20 Trace Mode = MAX HOLD	M1 : 5776.804 MHz : -2.207 dBm M2 : 5780.170 MHz : 5.303 dBm Delta1 : 36.393 MHz : 1.940 dB T1 : 5766.222 MHz : -15.447 dBm T2 : 5826.503 MHz : -13.759 dBm OBW : 60.281 MHz	Measured 26 dB Bandwidth: 36.393 MHz Measured 99% Bandwidth: 60.281 MHz

[back to matrix](#)

This test report may be reproduced in full only. The document may only be updated by MiCOM Labs personnel. Any changes will be noted in the Document History section of the report.



Title: NetScout Systems Inc. SENSOR4 Product Family
To: FCC CFR 47 Part 15 Subpart E 15.407 & IC RSS-247
Serial #: NTCT77-U4 Rev B
Issue Date: 12th December 2016
Page: 94 of 128



6 dB & 99% BANDWIDTH

Variante: 802.11n HT-40, Channel: 5795.00 MHz, Chain b, Temp: 20, Voltage: 48 Vdc

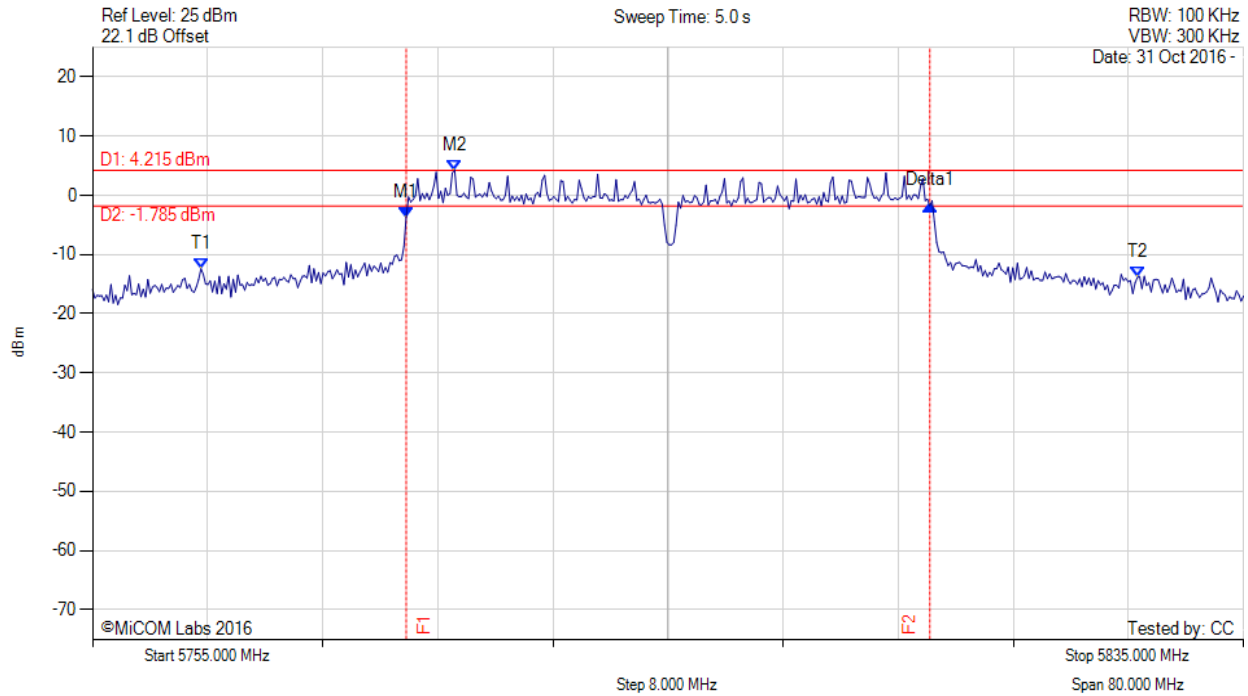

Analyzer Setup	Marker:Frequency:Amplitude	Test Results
Detector = MAX PEAK Sweep Count = 0 RF Atten (dB) = 20 Trace Mode = MAX HOLD	M1 : 5776.804 MHz : -3.680 dBm M2 : 5780.170 MHz : 4.215 dBm Delta1 : 36.393 MHz : 1.920 dB T1 : 5762.535 MHz : -12.403 dBm T2 : 5827.625 MHz : -13.891 dBm OBW : 65.090 MHz	Measured 26 dB Bandwidth: 36.393 MHz Measured 99% Bandwidth: 65.090 MHz

[back to matrix](#)

This test report may be reproduced in full only. The document may only be updated by MiCOM Labs personnel. Any changes will be noted in the Document History section of the report.



Title: NetScout Systems Inc. SENSOR4 Product Family
To: FCC CFR 47 Part 15 Subpart E 15.407 & IC RSS-247
Serial #: NTCT77-U4 Rev B
Issue Date: 12th December 2016
Page: 95 of 128



6 dB & 99% BANDWIDTH

Variant: 802.11n HT-40, Channel: 5795.00 MHz, Chain c, Temp: 20, Voltage: 48 Vdc

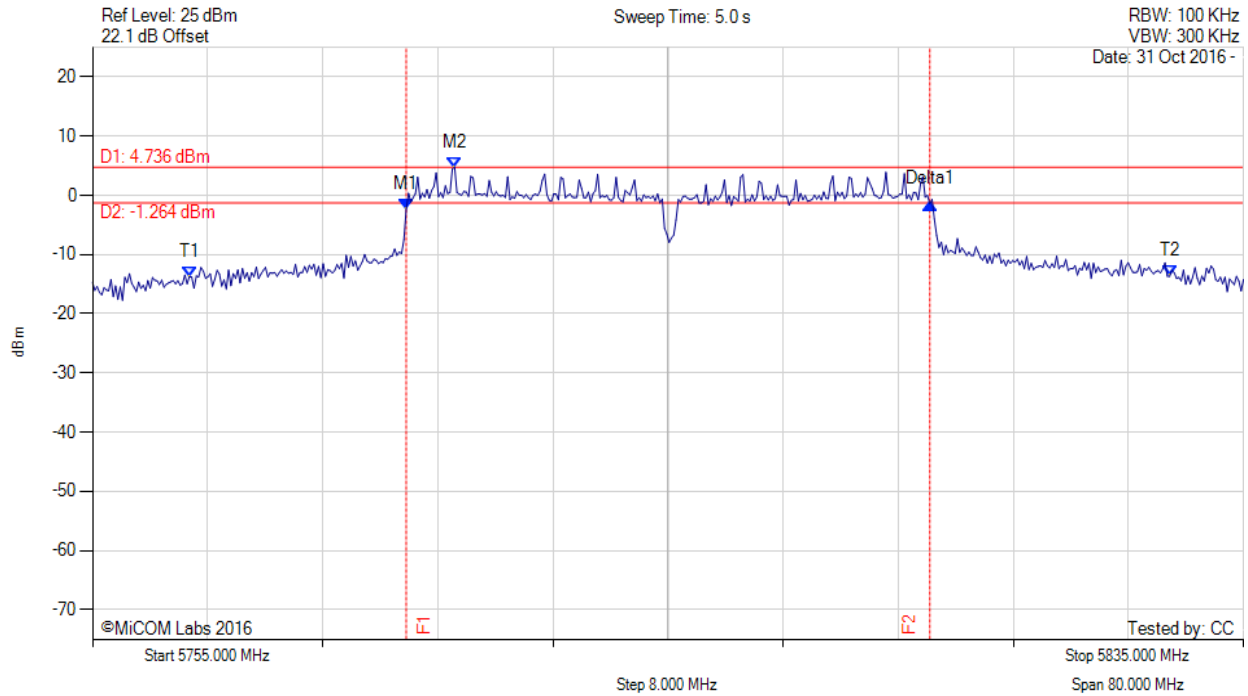

Analyzer Setup	Marker:Frequency:Amplitude	Test Results
Detector = MAX PEAK Sweep Count = 0 RF Atten (dB) = 20 Trace Mode = MAX HOLD	M1 : 5776.804 MHz : -2.399 dBm M2 : 5780.170 MHz : 4.736 dBm Delta1 : 36.393 MHz : 0.984 dB T1 : 5761.733 MHz : -13.745 dBm T2 : 5829.870 MHz : -13.680 dBm OBW : 68.136 MHz	Measured 26 dB Bandwidth: 36.393 MHz Measured 99% Bandwidth: 68.136 MHz

[back to matrix](#)

This test report may be reproduced in full only. The document may only be updated by MiCOM Labs personnel. Any changes will be noted in the Document History section of the report.



A.2. Power Spectral Density

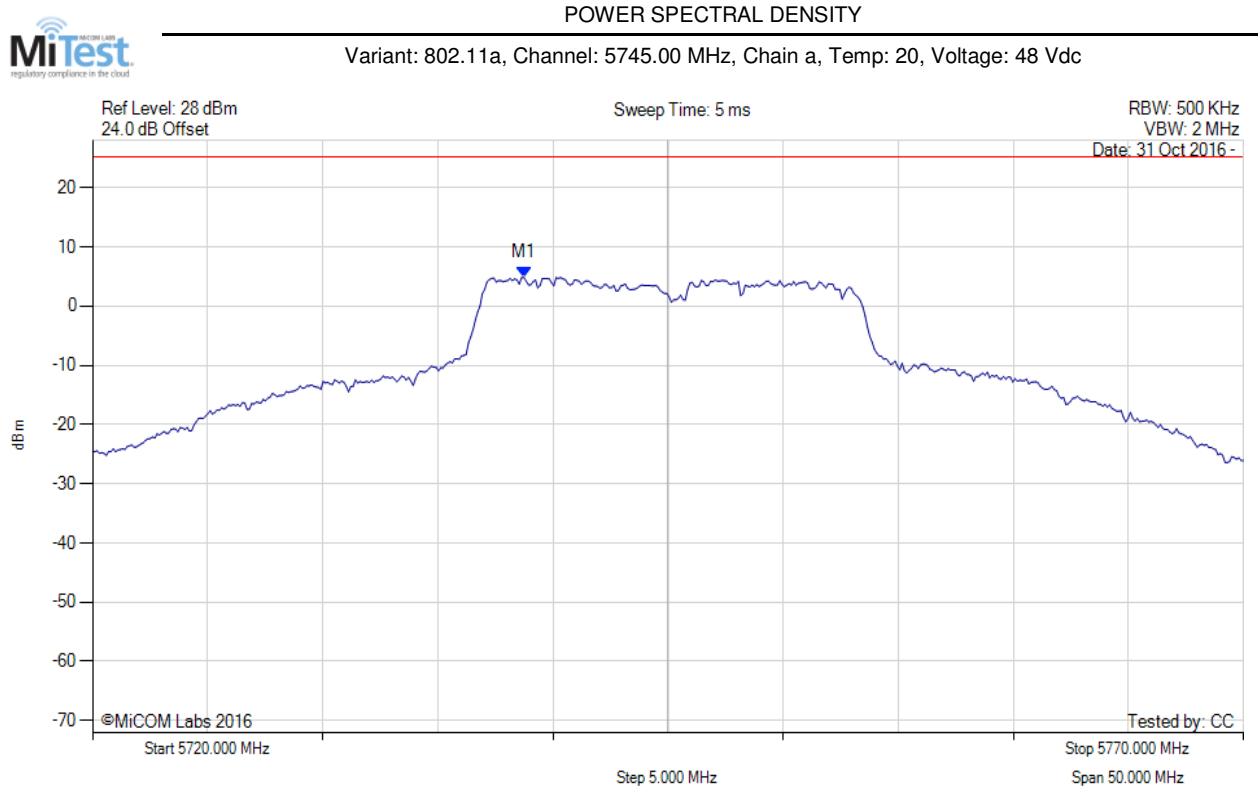

Analyzer Setup	Marker:Frequency:Amplitude	Test Results
Detector = RMS Sweep Count = 100 RF Atten (dB) = 20 Trace Mode = VIEW	M1 : 5738.737 MHz : 4.842 dBm	Limit: ≤ 25.230 dBm

[back to matrix](#)

This test report may be reproduced in full only. The document may only be updated by MiCOM Labs personnel. Any changes will be noted in the Document History section of the report.



Title: NetScout Systems Inc. SENSOR4 Product Family
To: FCC CFR 47 Part 15 Subpart E 15.407 & IC RSS-247
Serial #: NTCT77-U4 Rev B
Issue Date: 12th December 2016
Page: 97 of 128

POWER SPECTRAL DENSITY



Variant: 802.11a, Channel: 5745.00 MHz, Chain b, Temp: 20, Voltage: 48 Vdc

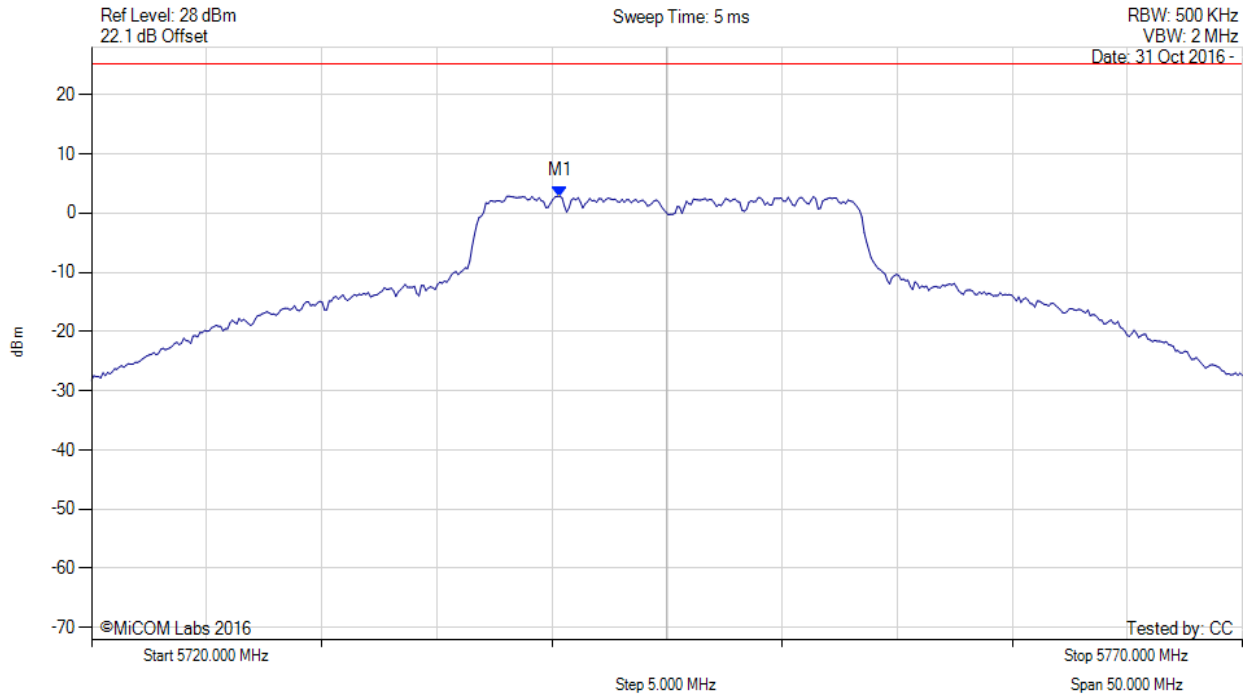

Analyzer Setup	Marker:Frequency:Amplitude	Test Results
Detector = RMS Sweep Count = 100 RF Atten (dB) = 20 Trace Mode = VIEW	M1 : 5740.341 MHz : 2.846 dBm	Limit: ≤ 25.230 dBm

[back to matrix](#)

This test report may be reproduced in full only. The document may only be updated by MiCOM Labs personnel. Any changes will be noted in the Document History section of the report.



Title: NetScout Systems Inc. SENSOR4 Product Family
To: FCC CFR 47 Part 15 Subpart E 15.407 & IC RSS-247
Serial #: NTCT77-U4 Rev B
Issue Date: 12th December 2016
Page: 98 of 128



POWER SPECTRAL DENSITY

Variant: 802.11a, Channel: 5745.00 MHz, Chain c, Temp: 20, Voltage: 48 Vdc

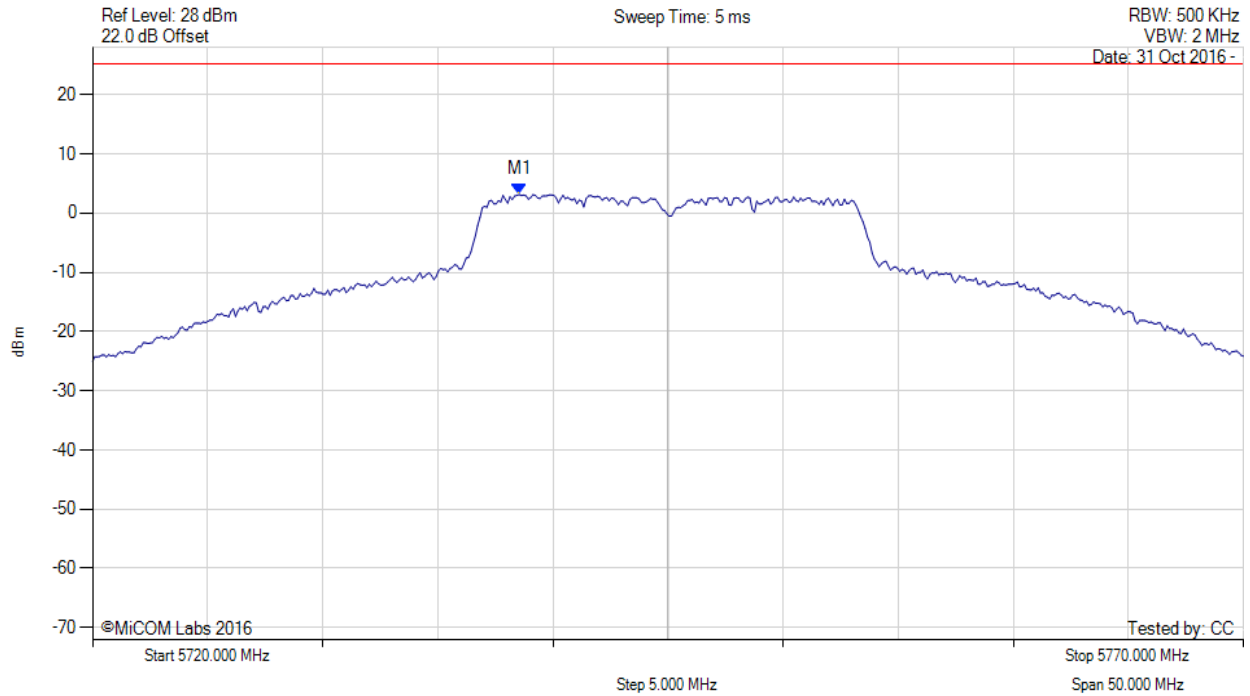

Analyzer Setup	Marker:Frequency:Amplitude	Test Results
Detector = RMS Sweep Count = 100 RF Atten (dB) = 20 Trace Mode = VIEW	M1 : 5738.537 MHz : 3.138 dBm	Limit: ≤ 25.230 dBm

[back to matrix](#)

This test report may be reproduced in full only. The document may only be updated by MiCOM Labs personnel. Any changes will be noted in the Document History section of the report.



Title: NetScout Systems Inc. SENSOR4 Product Family
To: FCC CFR 47 Part 15 Subpart E 15.407 & IC RSS-247
Serial #: NTCT77-U4 Rev B
Issue Date: 12th December 2016
Page: 99 of 128



POWER SPECTRAL DENSITY

Variant: 802.11a, Channel: 5745.00 MHz, SUM, Temp: 20, Voltage: 48 Vdc

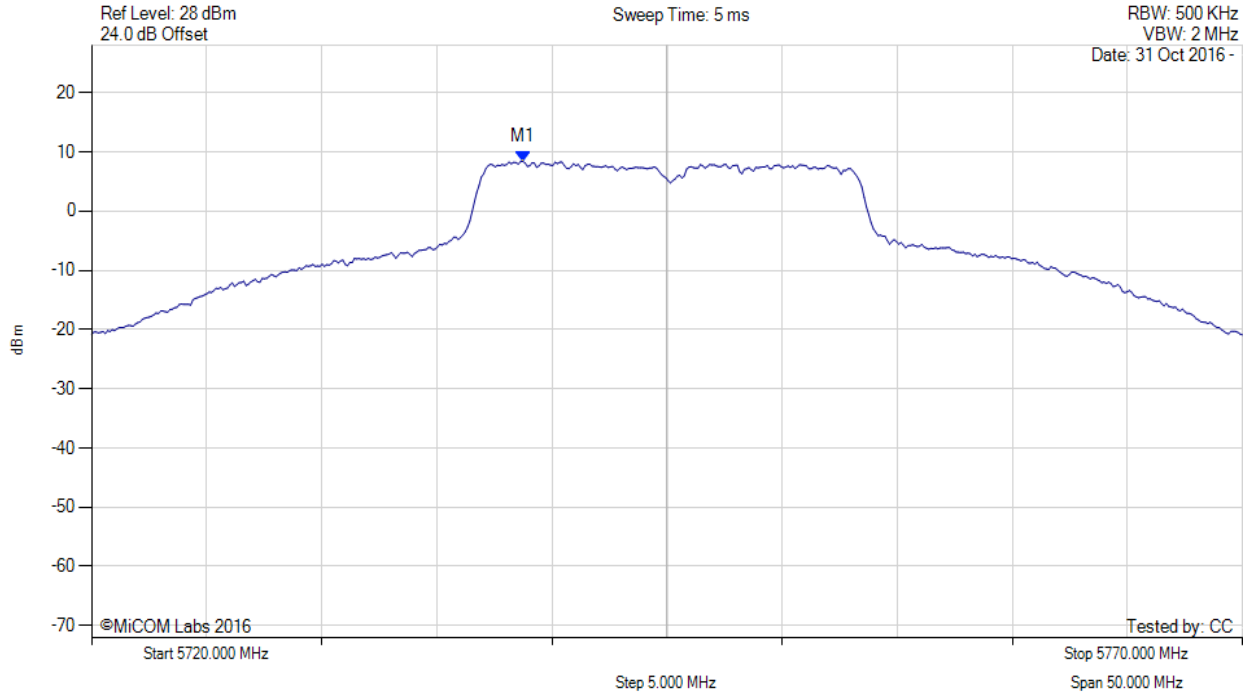

Analyzer Setup	Marker:Frequency:Amplitude	Test Results
Detector = RMS Sweep Count = 100 RF Atten (dB) = 20 Trace Mode = VIEW	M1 : 5738.700 MHz : 8.427 dBm M1 + DCCF : 5738.700 MHz : 8.471 dBm Duty Cycle Correction Factor : +0.04 dB	Limit: ≤ 30.0 dBm Margin: -21.5 dB

[back to matrix](#)

This test report may be reproduced in full only. The document may only be updated by MiCOM Labs personnel. Any changes will be noted in the Document History section of the report.



Title: NetScout Systems Inc. SENSOR4 Product Family
To: FCC CFR 47 Part 15 Subpart E 15.407 & IC RSS-247
Serial #: NTCT77-U4 Rev B
Issue Date: 12th December 2016
Page: 100 of 128

POWER SPECTRAL DENSITY



Variants: 802.11a, Channel: 5785.00 MHz, Chain a, Temp: 20, Voltage: 48 Vdc

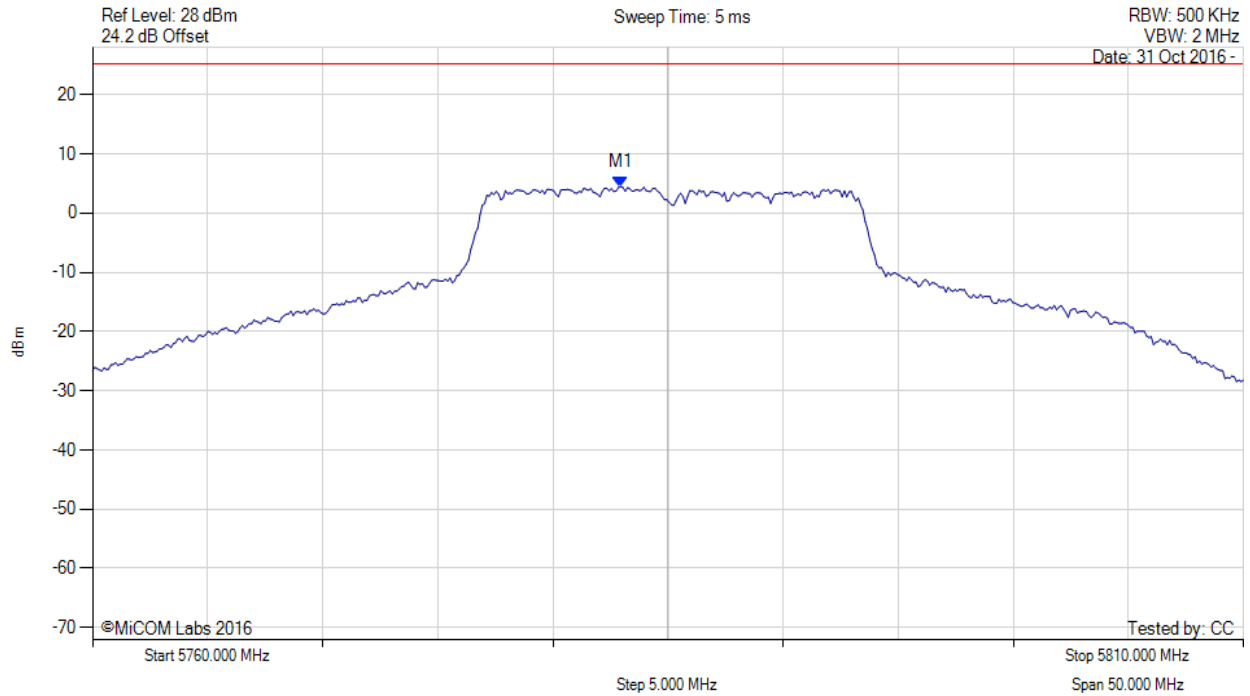

Analyzer Setup	Marker:Frequency:Amplitude	Test Results
Detector = RMS Sweep Count = 100 RF Atten (dB) = 20 Trace Mode = VIEW	M1 : 5782.946 MHz : 4.452 dBm	Limit: ≤ 25.230 dBm

[back to matrix](#)

This test report may be reproduced in full only. The document may only be updated by MiCOM Labs personnel. Any changes will be noted in the Document History section of the report.



Title: NetScout Systems Inc. SENSOR4 Product Family
To: FCC CFR 47 Part 15 Subpart E 15.407 & IC RSS-247
Serial #: NTCT77-U4 Rev B
Issue Date: 12th December 2016
Page: 101 of 128

POWER SPECTRAL DENSITY



Variant: 802.11a, Channel: 5785.00 MHz, Chain b, Temp: 20, Voltage: 48 Vdc

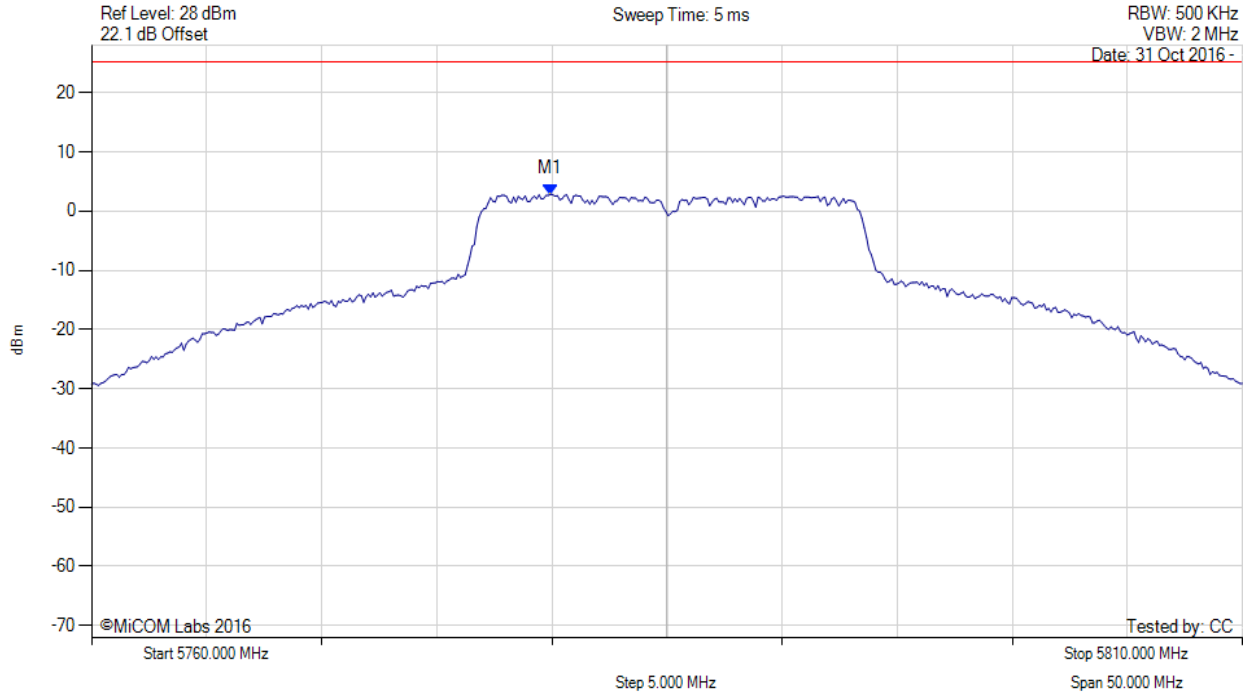

Analyzer Setup	Marker:Frequency:Amplitude	Test Results
Detector = RMS Sweep Count = 100 RF Atten (dB) = 20 Trace Mode = VIEW	M1 : 5779.940 MHz : 2.846 dBm	Channel Frequency: 5785.00 MHz

[back to matrix](#)

This test report may be reproduced in full only. The document may only be updated by MiCOM Labs personnel. Any changes will be noted in the Document History section of the report.



Title: NetScout Systems Inc. SENSOR4 Product Family
To: FCC CFR 47 Part 15 Subpart E 15.407 & IC RSS-247
Serial #: NTCT77-U4 Rev B
Issue Date: 12th December 2016
Page: 102 of 128



POWER SPECTRAL DENSITY

Variant: 802.11a, Channel: 5785.00 MHz, Chain c, Temp: 20, Voltage: 48 Vdc

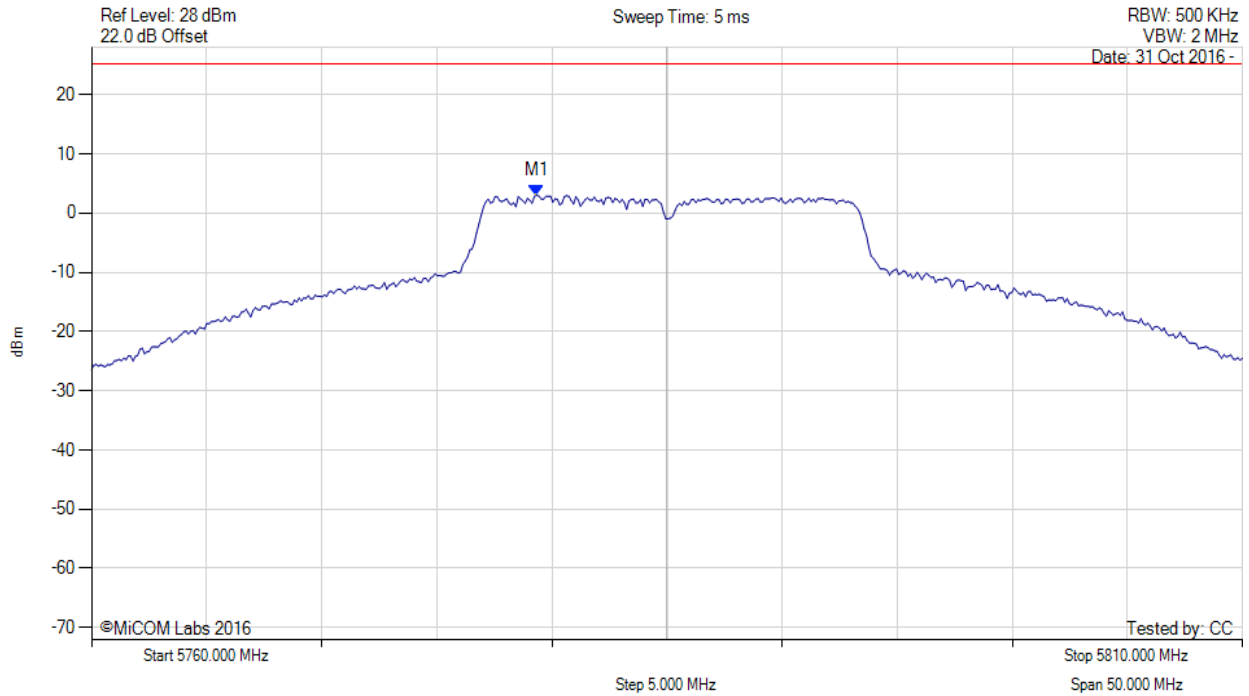

Analyzer Setup	Marker:Frequency:Amplitude	Test Results
Detector = RMS Sweep Count = 100 RF Atten (dB) = 20 Trace Mode = VIEW	M1 : 5779.339 MHz : 3.029 dBm	Limit: ≤ 25.230 dBm

[back to matrix](#)

This test report may be reproduced in full only. The document may only be updated by MiCOM Labs personnel. Any changes will be noted in the Document History section of the report.



Title: NetScout Systems Inc. SENSOR4 Product Family
To: FCC CFR 47 Part 15 Subpart E 15.407 & IC RSS-247
Serial #: NTCT77-U4 Rev B
Issue Date: 12th December 2016
Page: 103 of 128



POWER SPECTRAL DENSITY

Variant: 802.11a, Channel: 5785.00 MHz, SUM, Temp: 20, Voltage: 48 Vdc

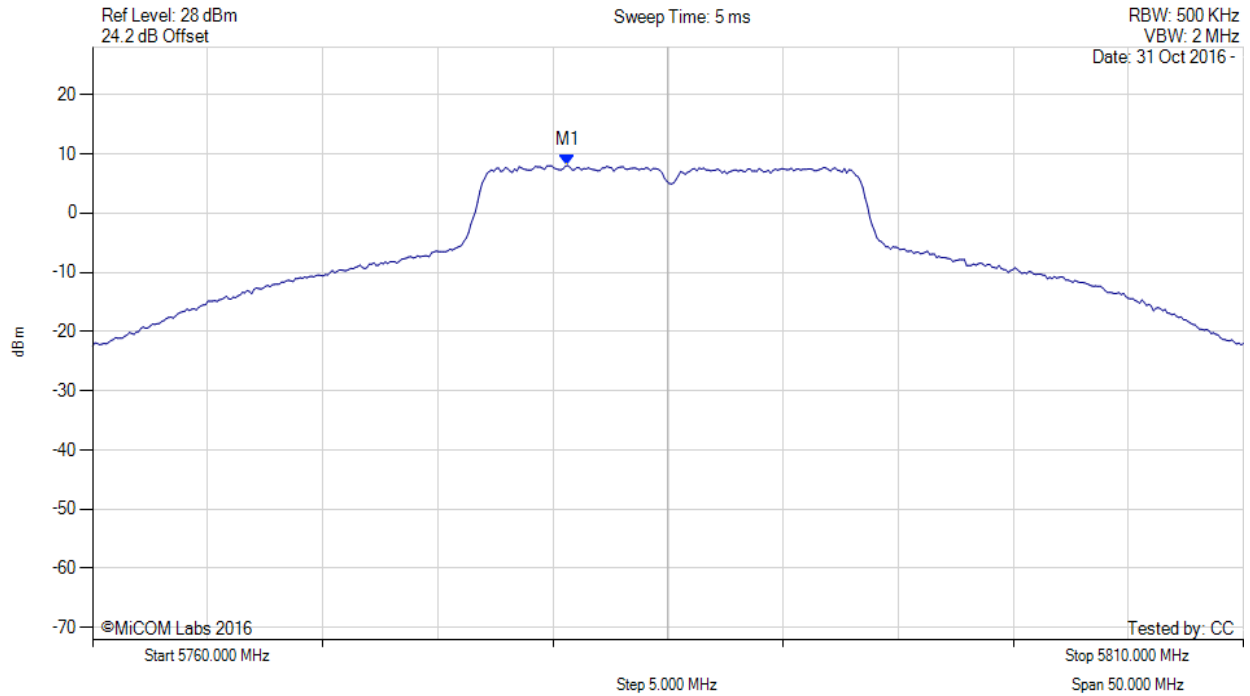

Analyzer Setup	Marker:Frequency:Amplitude	Test Results
Detector = RMS Sweep Count = 100 RF Atten (dB) = 20 Trace Mode = VIEW	M1 : 5780.600 MHz : 8.043 dBm M1 + DCCF : 5780.600 MHz : 8.087 dBm Duty Cycle Correction Factor : +0.04 dB	Limit: ≤ 30.0 dBm Margin: -21.9 dB

[back to matrix](#)

This test report may be reproduced in full only. The document may only be updated by MiCOM Labs personnel. Any changes will be noted in the Document History section of the report.



Title: NetScout Systems Inc. SENSOR4 Product Family
To: FCC CFR 47 Part 15 Subpart E 15.407 & IC RSS-247
Serial #: NTCT77-U4 Rev B
Issue Date: 12th December 2016
Page: 104 of 128

POWER SPECTRAL DENSITY



Variants: 802.11a, Channel: 5825.00 MHz, Chain a, Temp: 20, Voltage: 48 Vdc

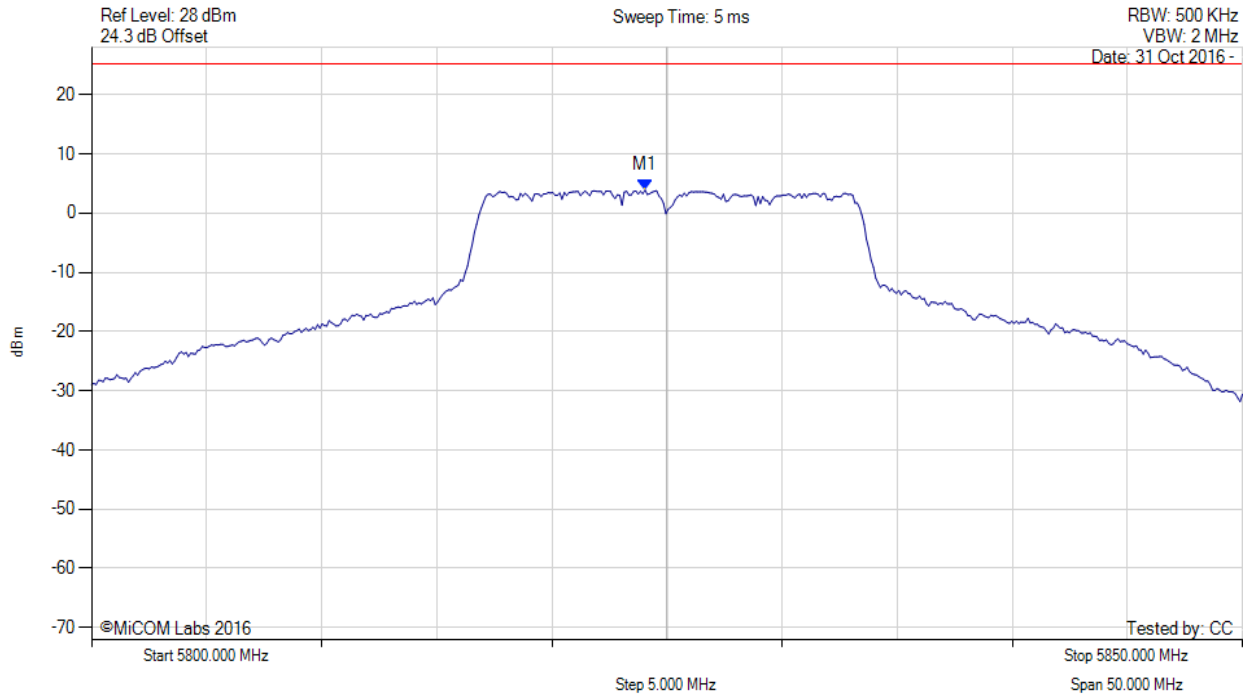

Analyzer Setup	Marker:Frequency:Amplitude	Test Results
Detector = RMS Sweep Count = 100 RF Atten (dB) = 20 Trace Mode = VIEW	M1 : 5824.048 MHz : 3.899 dBm	Limit: ≤ 25.230 dBm

[back to matrix](#)

This test report may be reproduced in full only. The document may only be updated by MiCOM Labs personnel. Any changes will be noted in the Document History section of the report.



Title: NetScout Systems Inc. SENSOR4 Product Family
To: FCC CFR 47 Part 15 Subpart E 15.407 & IC RSS-247
Serial #: NTCT77-U4 Rev B
Issue Date: 12th December 2016
Page: 105 of 128

POWER SPECTRAL DENSITY



Variation: 802.11a, Channel: 5825.00 MHz, Chain b, Temp: 20, Voltage: 48 Vdc

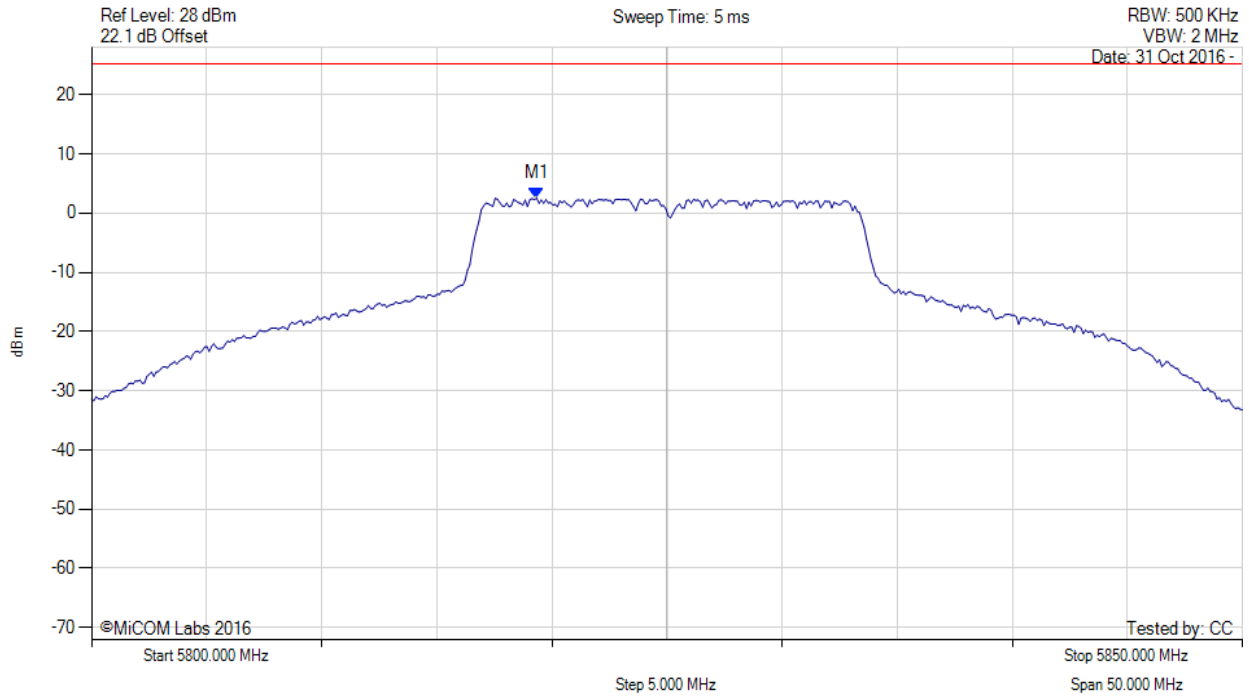

Analyzer Setup	Marker:Frequency:Amplitude	Test Results
Detector = RMS Sweep Count = 100 RF Atten (dB) = 20 Trace Mode = VIEW	M1 : 5819.339 MHz : 2.528 dBm	Limit: ≤ 25.230 dBm

[back to matrix](#)

This test report may be reproduced in full only. The document may only be updated by MiCOM Labs personnel. Any changes will be noted in the Document History section of the report.



Title: NetScout Systems Inc. SENSOR4 Product Family
To: FCC CFR 47 Part 15 Subpart E 15.407 & IC RSS-247
Serial #: NTCT77-U4 Rev B
Issue Date: 12th December 2016
Page: 106 of 128



POWER SPECTRAL DENSITY

Variant: 802.11a, Channel: 5825.00 MHz, Chain c, Temp: 20, Voltage: 48 Vdc

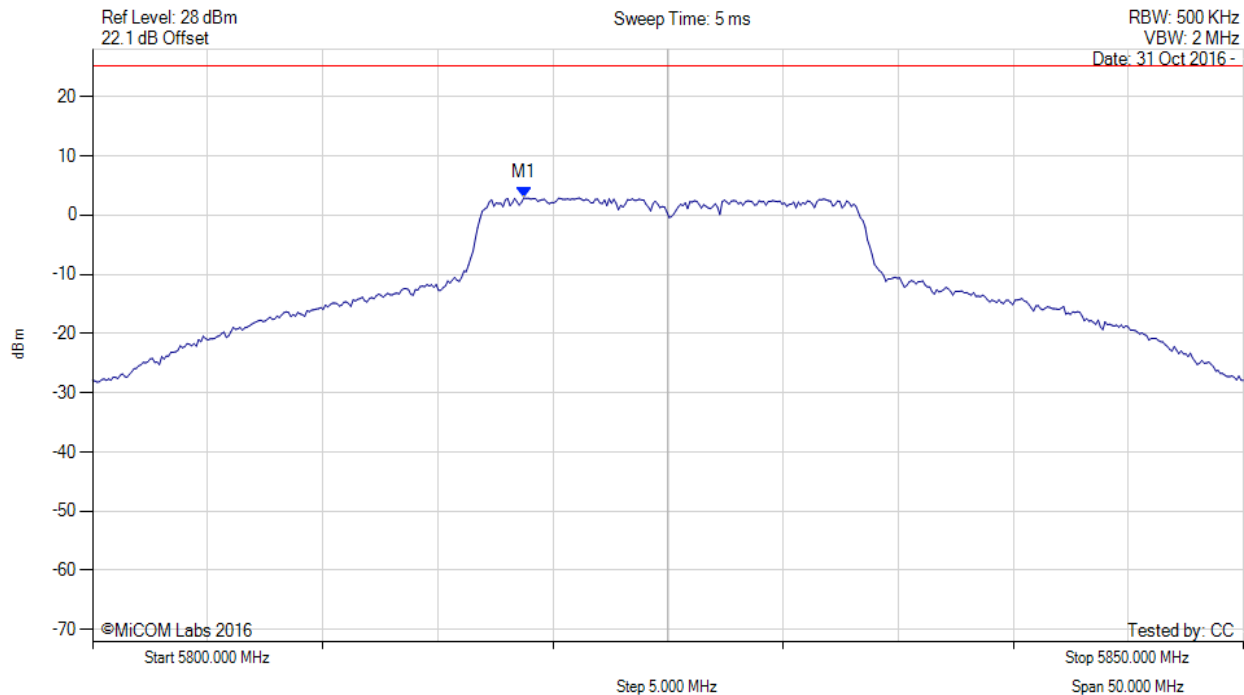

Analyzer Setup	Marker:Frequency:Amplitude	Test Results
Detector = RMS Sweep Count = 100 RF Atten (dB) = 20 Trace Mode = VIEW	M1 : 5818.737 MHz : 2.903 dBm	Limit: ≤ 25.230 dBm

[back to matrix](#)

This test report may be reproduced in full only. The document may only be updated by MiCOM Labs personnel. Any changes will be noted in the Document History section of the report.



Title: NetScout Systems Inc. SENSOR4 Product Family
To: FCC CFR 47 Part 15 Subpart E 15.407 & IC RSS-247
Serial #: NTCT77-U4 Rev B
Issue Date: 12th December 2016
Page: 107 of 128



POWER SPECTRAL DENSITY

Variant: 802.11a, Channel: 5825.00 MHz, SUM, Temp: 20, Voltage: 48 Vdc

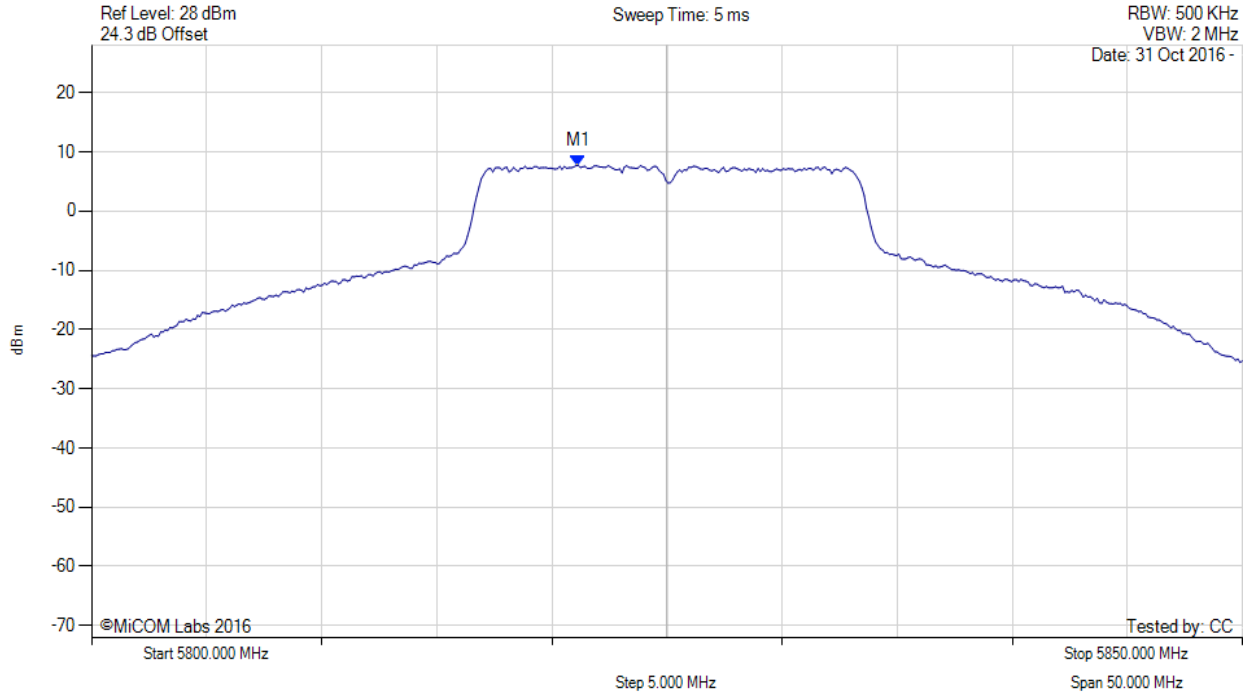

Analyzer Setup	Marker:Frequency:Amplitude	Test Results
Detector = RMS Sweep Count = 100 RF Atten (dB) = 20 Trace Mode = VIEW	M1 : 5821.100 MHz : 7.727 dBm M1 + DCCF : 5821.100 MHz : 7.771 dBm Duty Cycle Correction Factor : +0.04 dB	Limit: ≤ 30.0 dBm Margin: -22.2 dB

[back to matrix](#)

This test report may be reproduced in full only. The document may only be updated by MiCOM Labs personnel. Any changes will be noted in the Document History section of the report.



Title: NetScout Systems Inc. SENSOR4 Product Family
To: FCC CFR 47 Part 15 Subpart E 15.407 & IC RSS-247
Serial #: NTCT77-U4 Rev B
Issue Date: 12th December 2016
Page: 108 of 128

POWER SPECTRAL DENSITY



Variant: 802.11n HT-20, Channel: 5745.00 MHz, Chain a, Temp: 20, Voltage: 48 Vdc

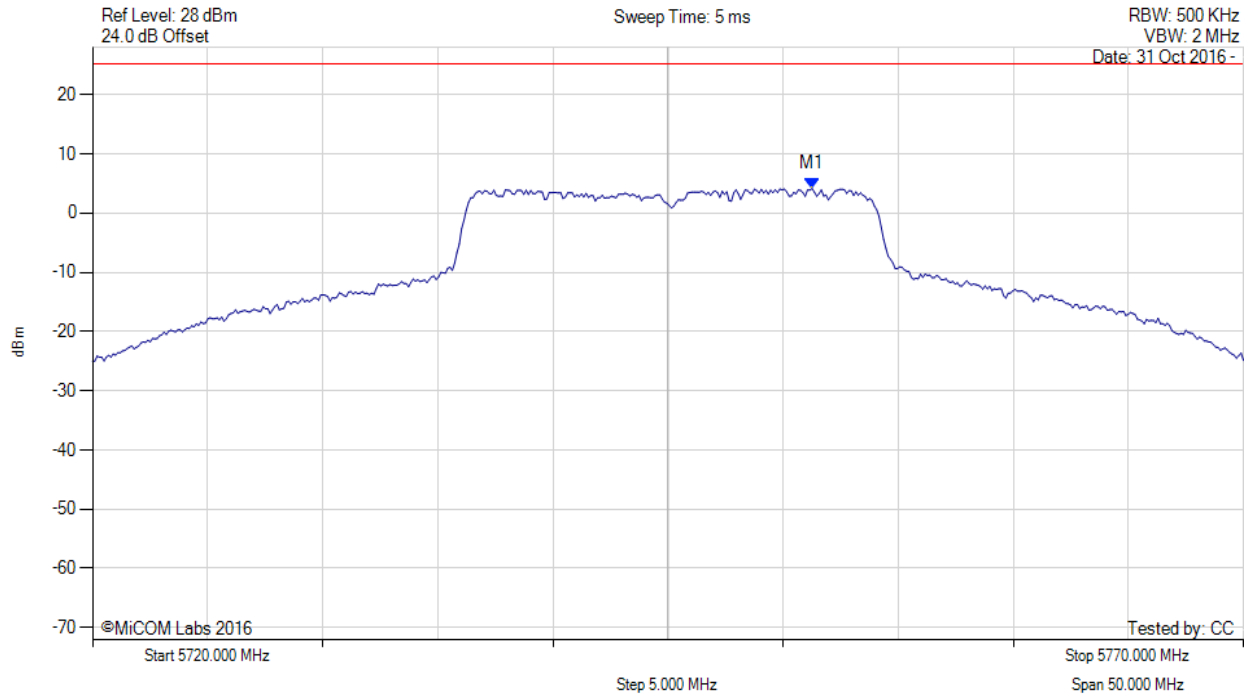

Analyzer Setup	Marker:Frequency:Amplitude	Test Results
Detector = RMS Sweep Count = 100 RF Atten (dB) = 20 Trace Mode = VIEW	M1 : 5751.263 MHz : 4.159 dBm	Limit: ≤ 25.230 dBm

[back to matrix](#)

This test report may be reproduced in full only. The document may only be updated by MiCOM Labs personnel. Any changes will be noted in the Document History section of the report.



Title: NetScout Systems Inc. SENSOR4 Product Family
To: FCC CFR 47 Part 15 Subpart E 15.407 & IC RSS-247
Serial #: NTCT77-U4 Rev B
Issue Date: 12th December 2016
Page: 109 of 128

POWER SPECTRAL DENSITY



Variant: 802.11n HT-20, Channel: 5745.00 MHz, Chain b, Temp: 20, Voltage: 48 Vdc

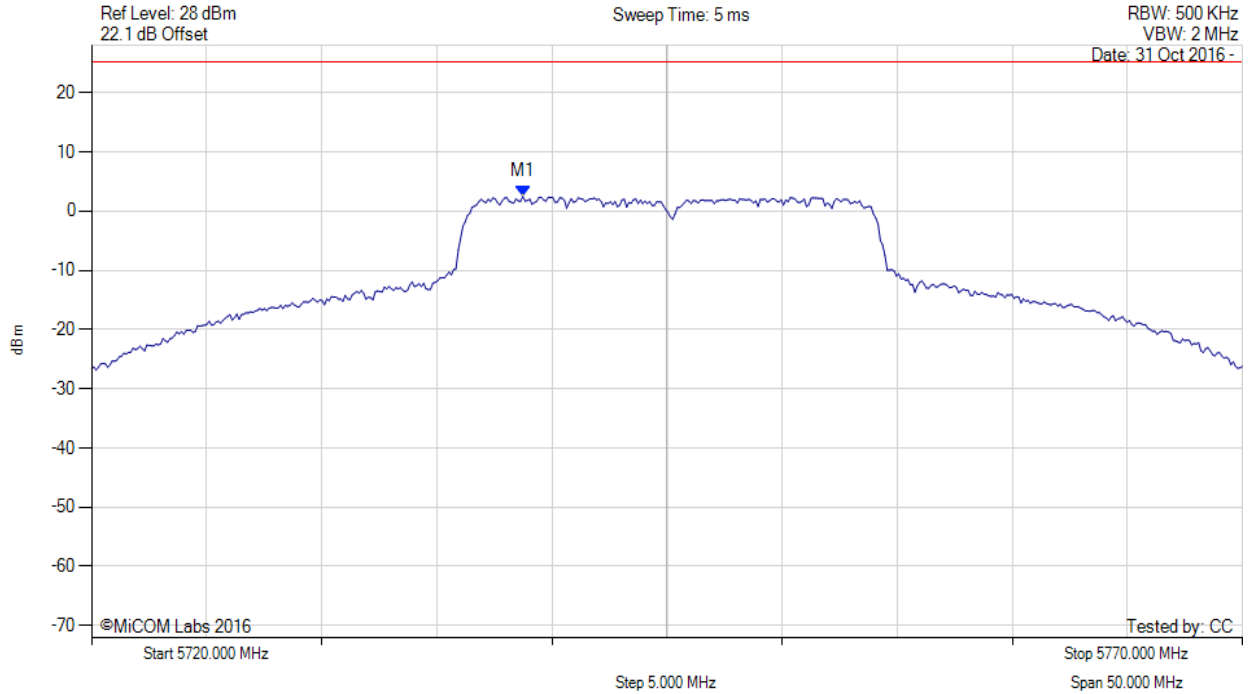

Analyzer Setup	Marker:Frequency:Amplitude	Test Results
Detector = RMS Sweep Count = 100 RF Atten (dB) = 20 Trace Mode = VIEW	M1 : 5738.737 MHz : 2.486 dBm	Limit: ≤ 25.230 dBm

[back to matrix](#)

This test report may be reproduced in full only. The document may only be updated by MiCOM Labs personnel. Any changes will be noted in the Document History section of the report.



Title: NetScout Systems Inc. SENSOR4 Product Family
To: FCC CFR 47 Part 15 Subpart E 15.407 & IC RSS-247
Serial #: NTCT77-U4 Rev B
Issue Date: 12th December 2016
Page: 110 of 128



POWER SPECTRAL DENSITY

Variant: 802.11n HT-20, Channel: 5745.00 MHz, Chain c, Temp: 20, Voltage: 48 Vdc

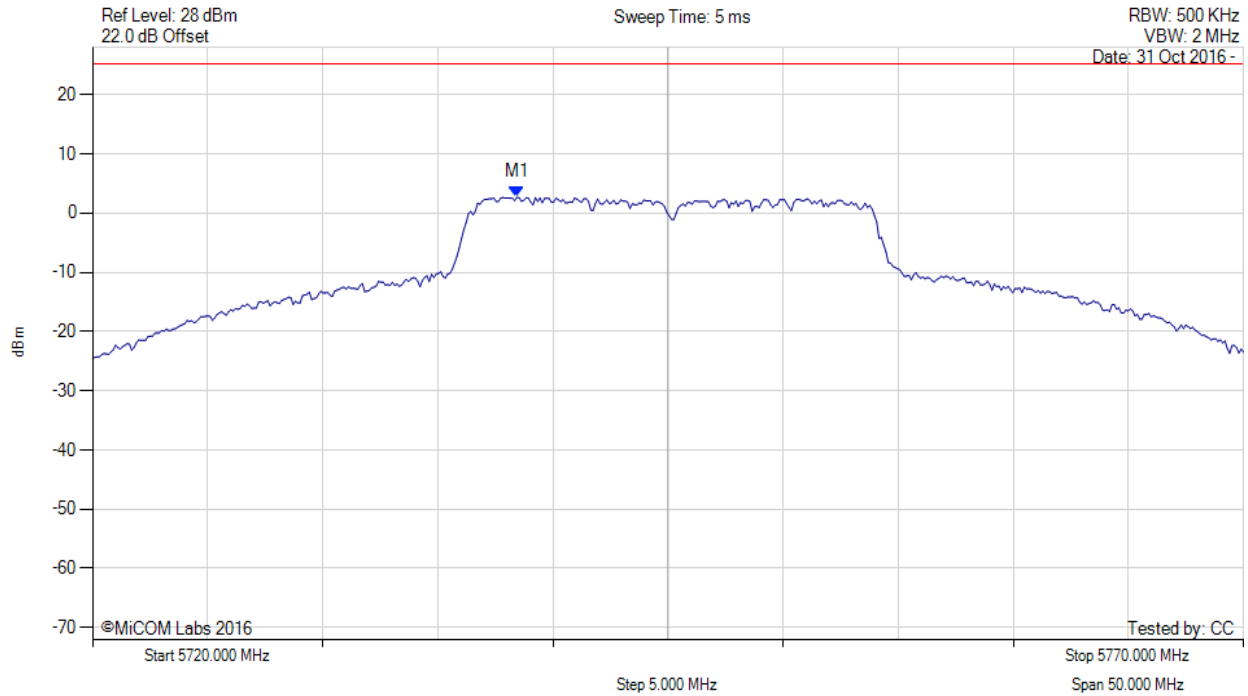

Analyzer Setup	Marker:Frequency:Amplitude	Test Results
Detector = RMS Sweep Count = 100 RF Atten (dB) = 20 Trace Mode = VIEW	M1 : 5738.437 MHz : 2.668 dBm	Limit: ≤ 25.230 dBm

[back to matrix](#)

This test report may be reproduced in full only. The document may only be updated by MiCOM Labs personnel. Any changes will be noted in the Document History section of the report.



Title: NetScout Systems Inc. SENSOR4 Product Family
To: FCC CFR 47 Part 15 Subpart E 15.407 & IC RSS-247
Serial #: NTCT77-U4 Rev B
Issue Date: 12th December 2016
Page: 111 of 128



POWER SPECTRAL DENSITY

Variant: 802.11n HT-20, Channel: 5745.00 MHz, SUM, Temp: 20, Voltage: 48 Vdc

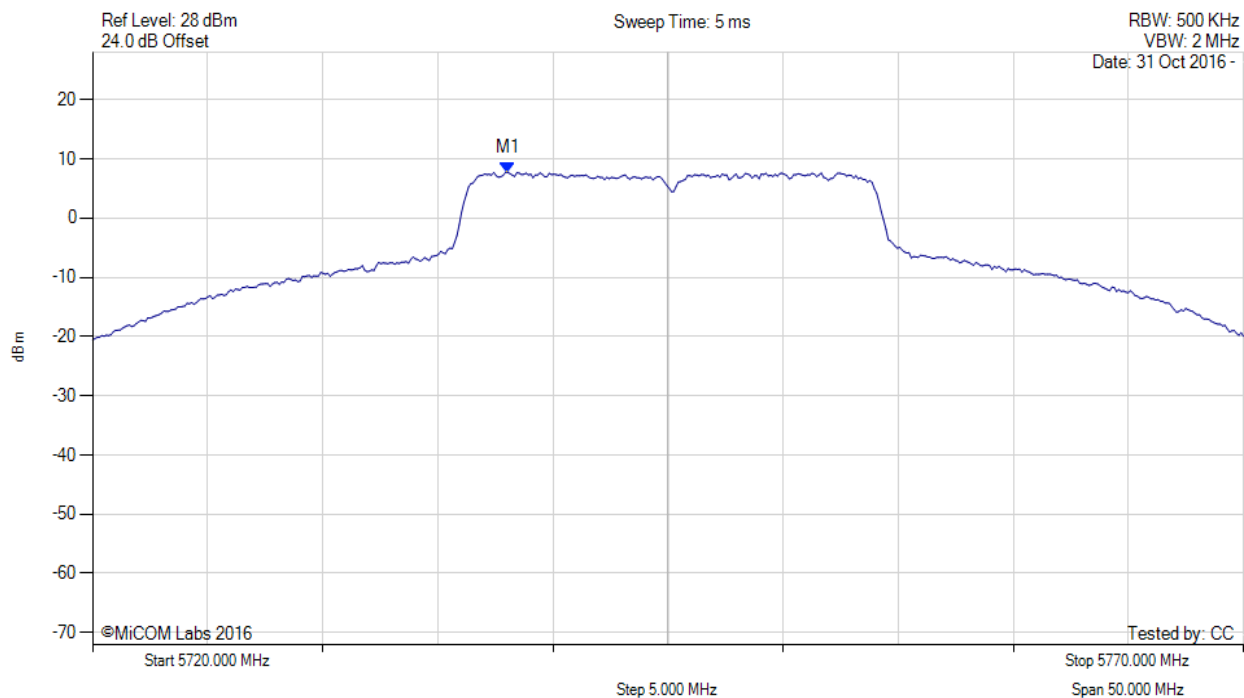

Analyzer Setup	Marker:Frequency:Amplitude	Test Results
Detector = RMS Sweep Count = 100 RF Atten (dB) = 20 Trace Mode = VIEW	M1 : 5738.000 MHz : 7.740 dBm M1 + DCCF : 5738.000 MHz : 7.784 dBm Duty Cycle Correction Factor : +0.04 dB	Limit: ≤ 30.0 dBm Margin: -22.2 dB

[back to matrix](#)

This test report may be reproduced in full only. The document may only be updated by MiCOM Labs personnel. Any changes will be noted in the Document History section of the report.



Title: NetScout Systems Inc. SENSOR4 Product Family
To: FCC CFR 47 Part 15 Subpart E 15.407 & IC RSS-247
Serial #: NTCT77-U4 Rev B
Issue Date: 12th December 2016
Page: 112 of 128

POWER SPECTRAL DENSITY



Variant: 802.11n HT-20, Channel: 5785.00 MHz, Chain a, Temp: 20, Voltage: 48 Vdc

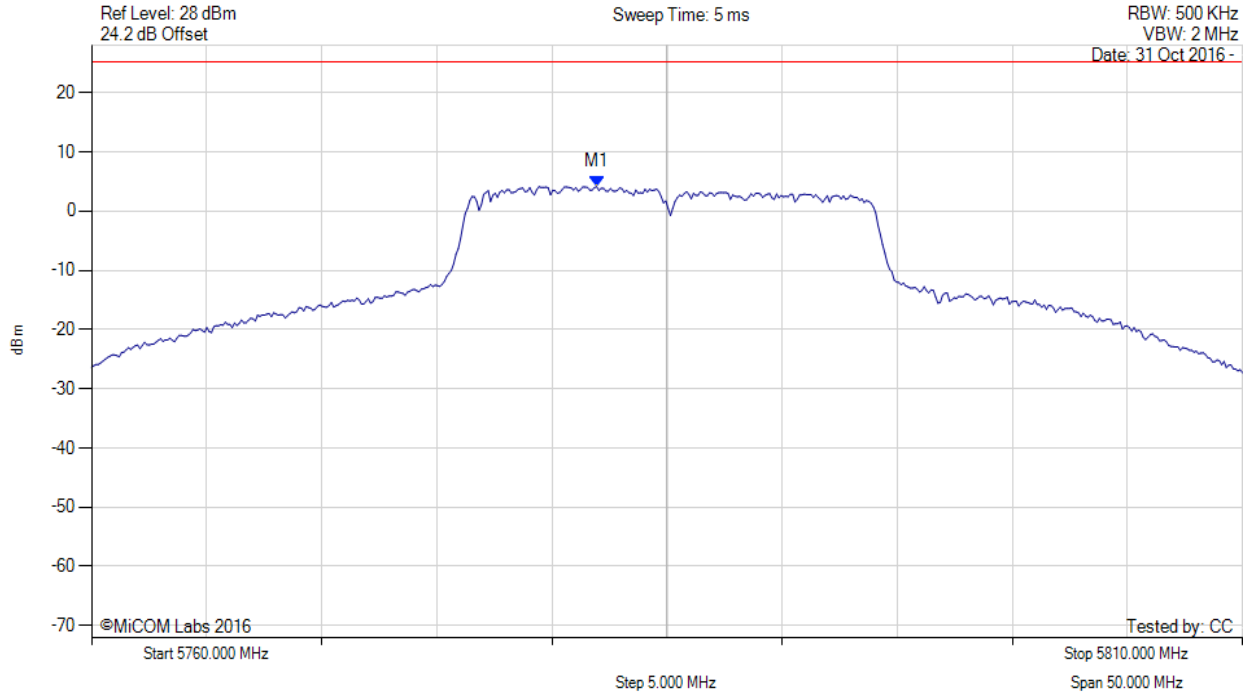

Analyzer Setup	Marker:Frequency:Amplitude	Test Results
Detector = RMS Sweep Count = 100 RF Atten (dB) = 20 Trace Mode = VIEW	M1 : 5781.944 MHz : 4.139 dBm	Limit: ≤ 25.230 dBm

[back to matrix](#)

This test report may be reproduced in full only. The document may only be updated by MiCOM Labs personnel. Any changes will be noted in the Document History section of the report.



Title: NetScout Systems Inc. SENSOR4 Product Family
To: FCC CFR 47 Part 15 Subpart E 15.407 & IC RSS-247
Serial #: NTCT77-U4 Rev B
Issue Date: 12th December 2016
Page: 113 of 128

POWER SPECTRAL DENSITY



Variant: 802.11n HT-20, Channel: 5785.00 MHz, Chain b, Temp: 20, Voltage: 48 Vdc

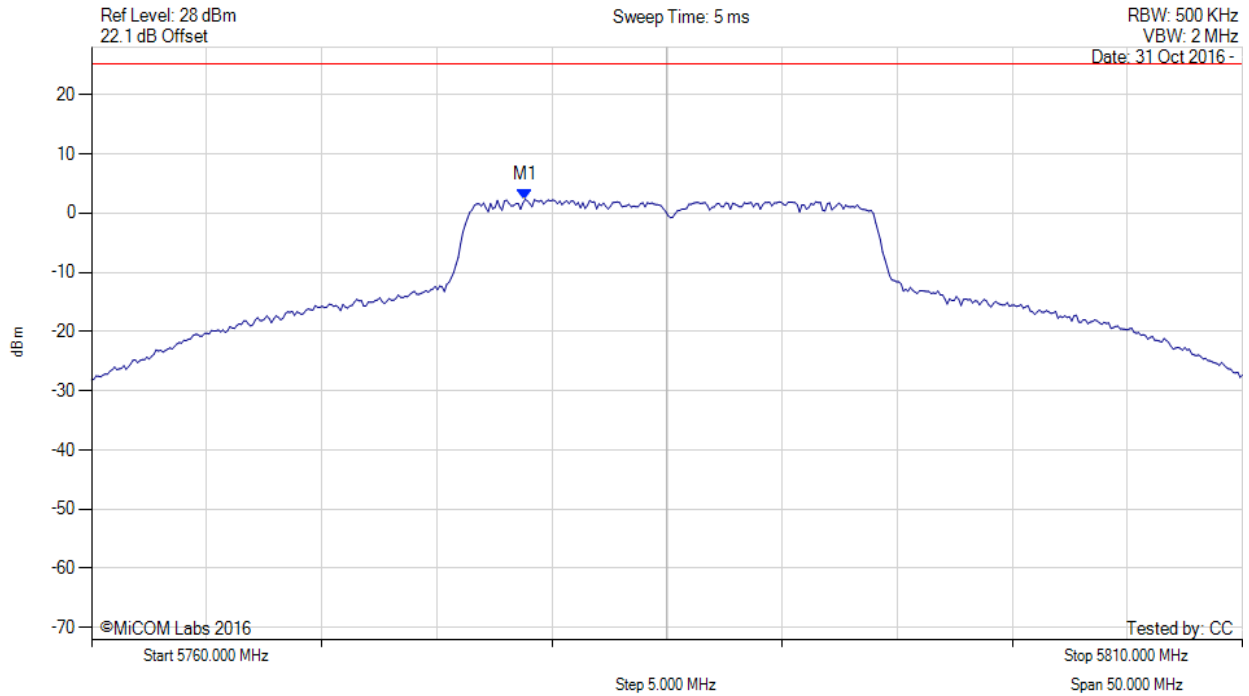

Analyzer Setup	Marker:Frequency:Amplitude	Test Results
Detector = RMS Sweep Count = 100 RF Atten (dB) = 20 Trace Mode = VIEW	M1 : 5778.838 MHz : 2.313 dBm	Channel Frequency: 5785.00 MHz

[back to matrix](#)

This test report may be reproduced in full only. The document may only be updated by MiCOM Labs personnel. Any changes will be noted in the Document History section of the report.



Title: NetScout Systems Inc. SENSOR4 Product Family
To: FCC CFR 47 Part 15 Subpart E 15.407 & IC RSS-247
Serial #: NTCT77-U4 Rev B
Issue Date: 12th December 2016
Page: 114 of 128



POWER SPECTRAL DENSITY

Variant: 802.11n HT-20, Channel: 5785.00 MHz, Chain c, Temp: 20, Voltage: 48 Vdc

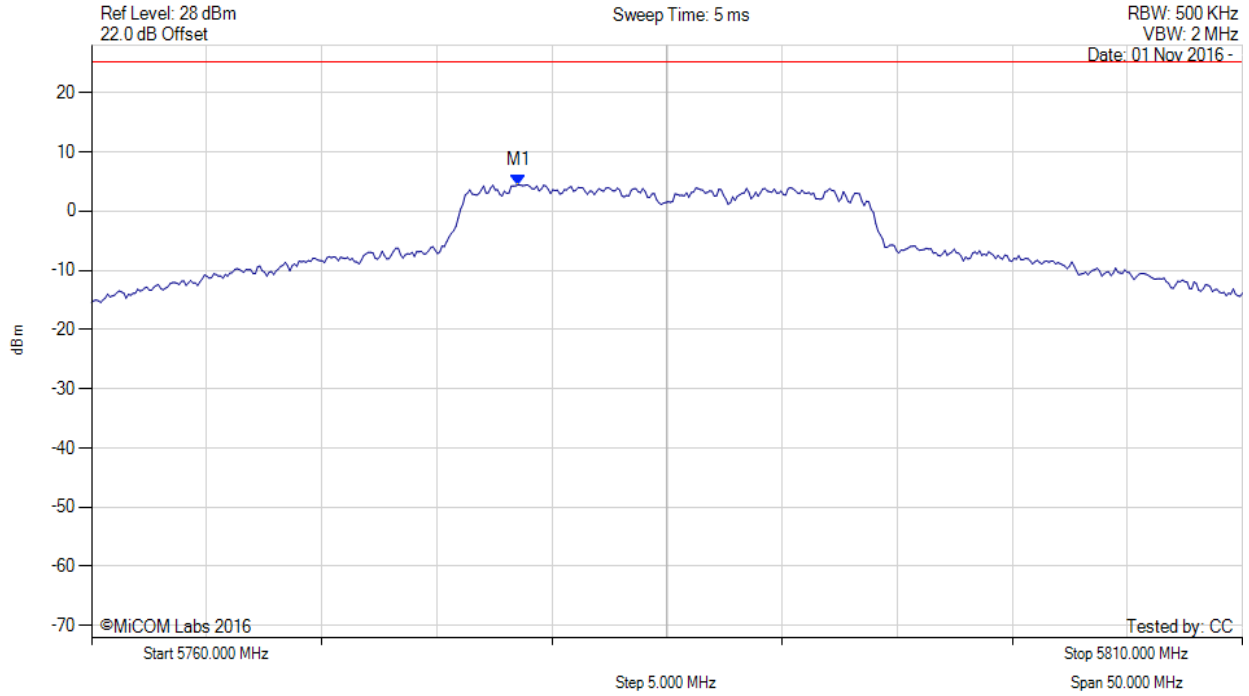

Analyzer Setup	Marker:Frequency:Amplitude	Test Results
Detector = RMS Sweep Count = 100 RF Atten (dB) = 20 Trace Mode = VIEW	M1 : 5778.537 MHz : 4.451 dBm	Limit: ≤ 25.230 dBm

[back to matrix](#)

This test report may be reproduced in full only. The document may only be updated by MiCOM Labs personnel. Any changes will be noted in the Document History section of the report.



Title: NetScout Systems Inc. SENSOR4 Product Family
To: FCC CFR 47 Part 15 Subpart E 15.407 & IC RSS-247
Serial #: NTCT77-U4 Rev B
Issue Date: 12th December 2016
Page: 115 of 128



POWER SPECTRAL DENSITY

Variant: 802.11n HT-20, Channel: 5785.00 MHz, SUM, Temp: 20, Voltage: 48 Vdc

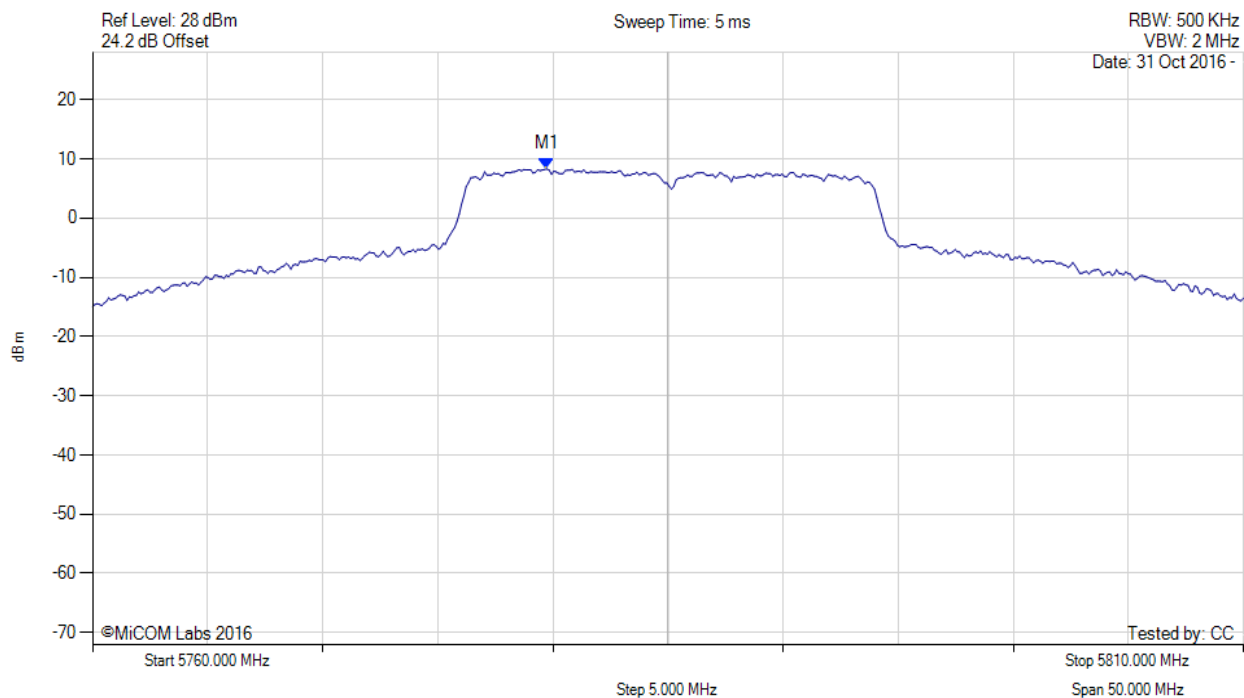

Analyzer Setup	Marker:Frequency:Amplitude	Test Results
Detector = RMS Sweep Count = 100 RF Atten (dB) = 20 Trace Mode = VIEW	M1 : 5779.700 MHz : 8.302 dBm M1 + DCCF : 5779.700 MHz : 8.346 dBm Duty Cycle Correction Factor : +0.04 dB	Limit: ≤ 30.0 dBm Margin: -21.6 dB

[back to matrix](#)

This test report may be reproduced in full only. The document may only be updated by MiCOM Labs personnel. Any changes will be noted in the Document History section of the report.



POWER SPECTRAL DENSITY



Variant: 802.11n HT-20, Channel: 5825.00 MHz, Chain a, Temp: 20, Voltage: 48 Vdc

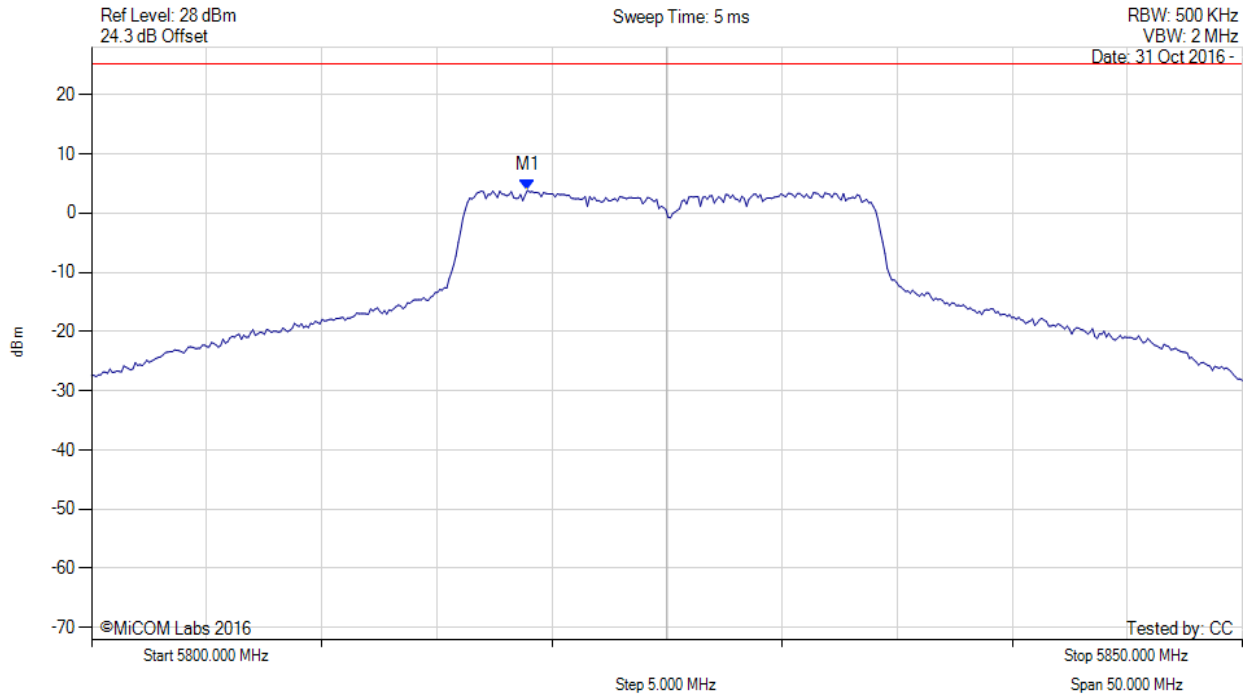

Analyzer Setup	Marker:Frequency:Amplitude	Test Results
Detector = RMS Sweep Count = 100 RF Atten (dB) = 20 Trace Mode = VIEW	M1 : 5818.938 MHz : 3.834 dBm	Limit: ≤ 25.230 dBm

[back to matrix](#)

This test report may be reproduced in full only. The document may only be updated by MiCOM Labs personnel. Any changes will be noted in the Document History section of the report.



POWER SPECTRAL DENSITY



Variant: 802.11n HT-20, Channel: 5825.00 MHz, Chain b, Temp: 20, Voltage: 48 Vdc

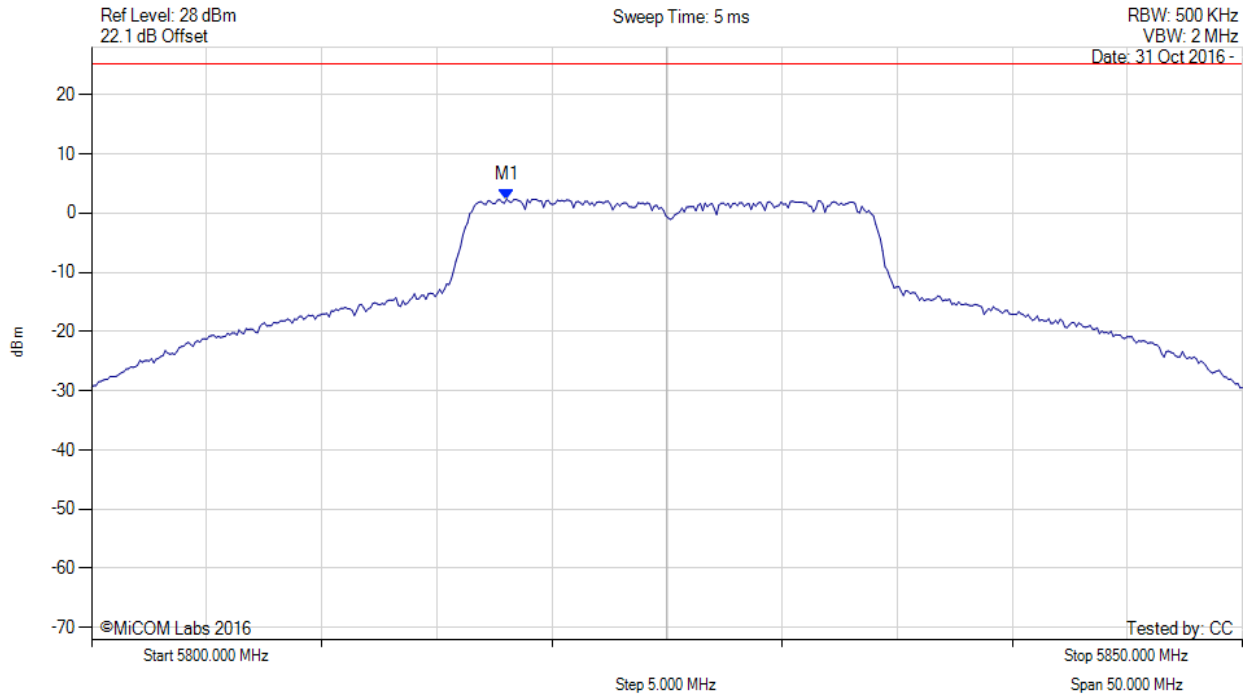

Analyzer Setup	Marker:Frequency:Amplitude	Test Results
Detector = RMS Sweep Count = 100 RF Atten (dB) = 20 Trace Mode = VIEW	M1 : 5818.036 MHz : 2.355 dBm	Limit: ≤ 25.230 dBm

[back to matrix](#)

This test report may be reproduced in full only. The document may only be updated by MiCOM Labs personnel. Any changes will be noted in the Document History section of the report.



Title: NetScout Systems Inc. SENSOR4 Product Family
To: FCC CFR 47 Part 15 Subpart E 15.407 & IC RSS-247
Serial #: NTCT77-U4 Rev B
Issue Date: 12th December 2016
Page: 118 of 128

POWER SPECTRAL DENSITY



Variant: 802.11n HT-20, Channel: 5825.00 MHz, Chain c, Temp: 20, Voltage: 48 Vdc

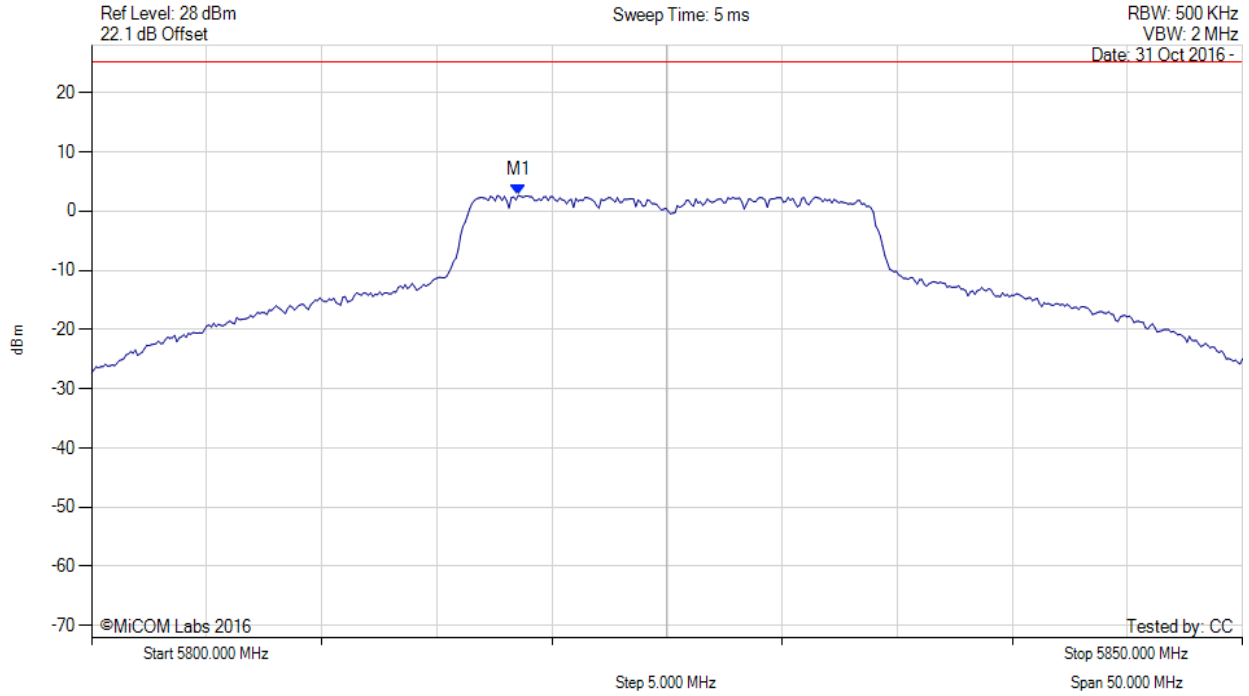

Analyzer Setup	Marker:Frequency:Amplitude	Test Results
Detector = RMS Sweep Count = 100 RF Atten (dB) = 20 Trace Mode = VIEW	M1 : 5818.537 MHz : 2.646 dBm	Limit: ≤ 25.230 dBm

[back to matrix](#)

This test report may be reproduced in full only. The document may only be updated by MiCOM Labs personnel. Any changes will be noted in the Document History section of the report.



Title: NetScout Systems Inc. SENSOR4 Product Family
To: FCC CFR 47 Part 15 Subpart E 15.407 & IC RSS-247
Serial #: NTCT77-U4 Rev B
Issue Date: 12th December 2016
Page: 119 of 128



POWER SPECTRAL DENSITY

Variant: 802.11n HT-20, Channel: 5825.00 MHz, SUM, Temp: 20, Voltage: 48 Vdc

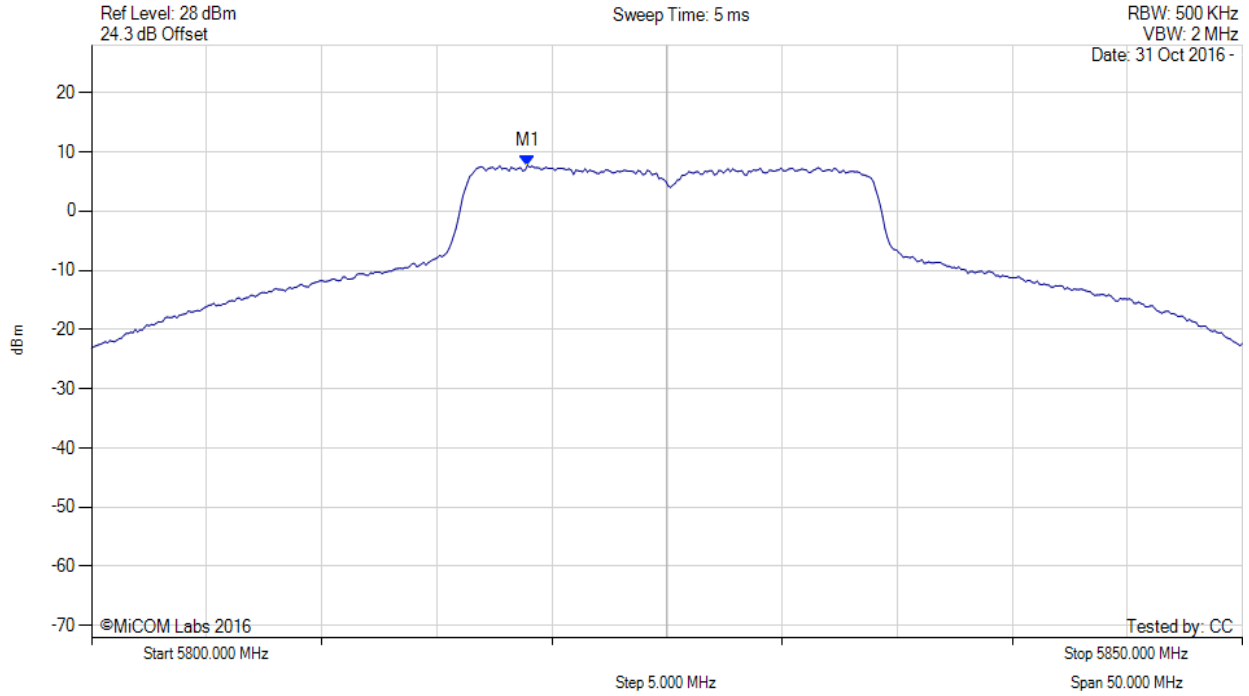

Analyzer Setup	Marker:Frequency:Amplitude	Test Results
Detector = RMS Sweep Count = 100 RF Atten (dB) = 20 Trace Mode = VIEW	M1 : 5818.900 MHz : 7.718 dBm M1 + DCCF : 5818.900 MHz : 7.762 dBm Duty Cycle Correction Factor : +0.04 dB	Limit: ≤ 30.0 dBm Margin: -22.2 dB

[back to matrix](#)

This test report may be reproduced in full only. The document may only be updated by MiCOM Labs personnel. Any changes will be noted in the Document History section of the report.



POWER SPECTRAL DENSITY

Variant: 802.11n HT-40, Channel: 5755.00 MHz, Chain a, Temp: 20, Voltage: 48 Vdc

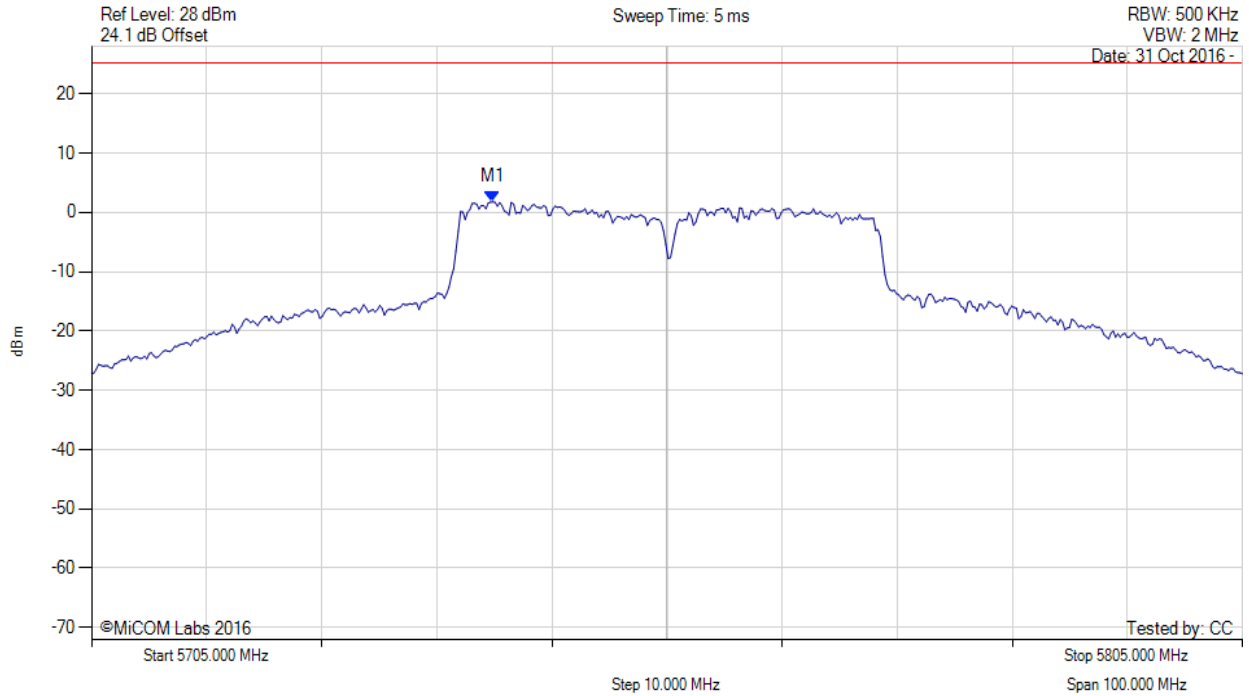

Analyzer Setup	Marker:Frequency:Amplitude	Test Results
Detector = RMS Sweep Count = 100 RF Atten (dB) = 20 Trace Mode = VIEW	M1 : 5739.870 MHz : 1.771 dBm	Limit: ≤ 25.230 dBm

[back to matrix](#)

This test report may be reproduced in full only. The document may only be updated by MiCOM Labs personnel. Any changes will be noted in the Document History section of the report.



Title: NetScout Systems Inc. SENSOR4 Product Family
To: FCC CFR 47 Part 15 Subpart E 15.407 & IC RSS-247
Serial #: NTCT77-U4 Rev B
Issue Date: 12th December 2016
Page: 121 of 128

POWER SPECTRAL DENSITY



Variant: 802.11n HT-40, Channel: 5755.00 MHz, Chain b, Temp: 20, Voltage: 48 Vdc

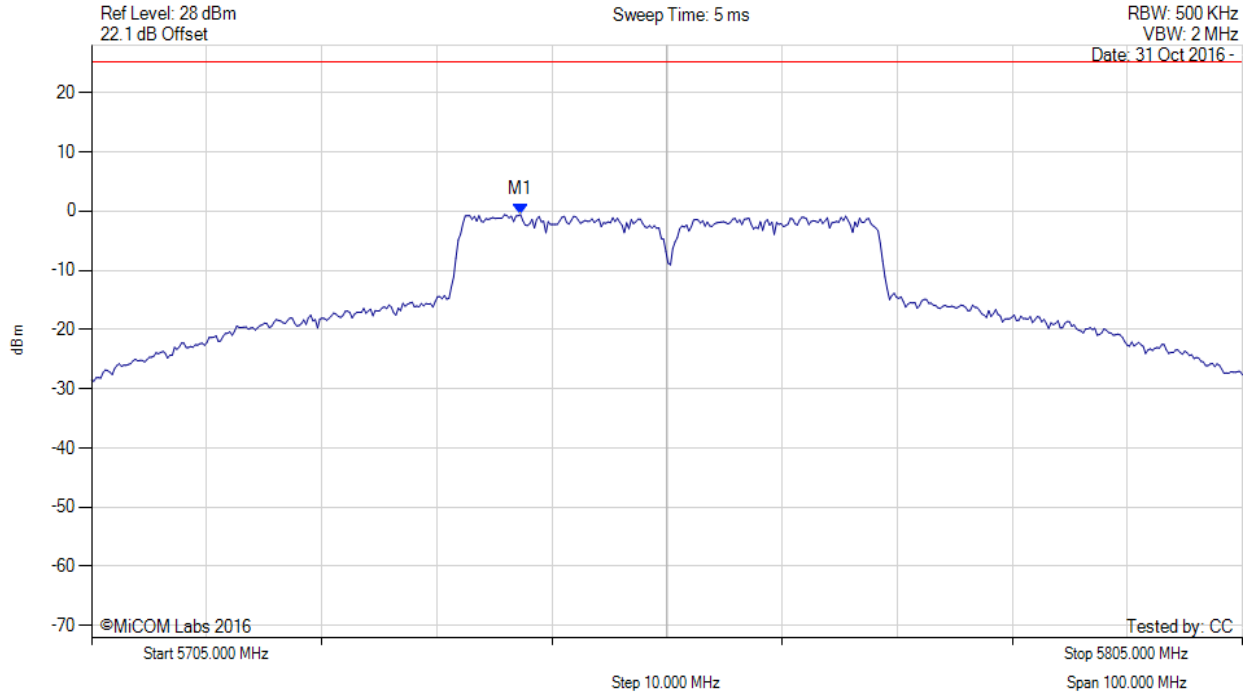

Analyzer Setup	Marker:Frequency:Amplitude	Test Results
Detector = RMS Sweep Count = 100 RF Atten (dB) = 20 Trace Mode = VIEW	M1 : 5742.275 MHz : -0.596 dBm	Limit: ≤ 25.230 dBm

[back to matrix](#)

This test report may be reproduced in full only. The document may only be updated by MiCOM Labs personnel. Any changes will be noted in the Document History section of the report.



Title: NetScout Systems Inc. SENSOR4 Product Family
To: FCC CFR 47 Part 15 Subpart E 15.407 & IC RSS-247
Serial #: NTCT77-U4 Rev B
Issue Date: 12th December 2016
Page: 122 of 128



POWER SPECTRAL DENSITY

Variant: 802.11n HT-40, Channel: 5755.00 MHz, Chain c, Temp: 20, Voltage: 48 Vdc

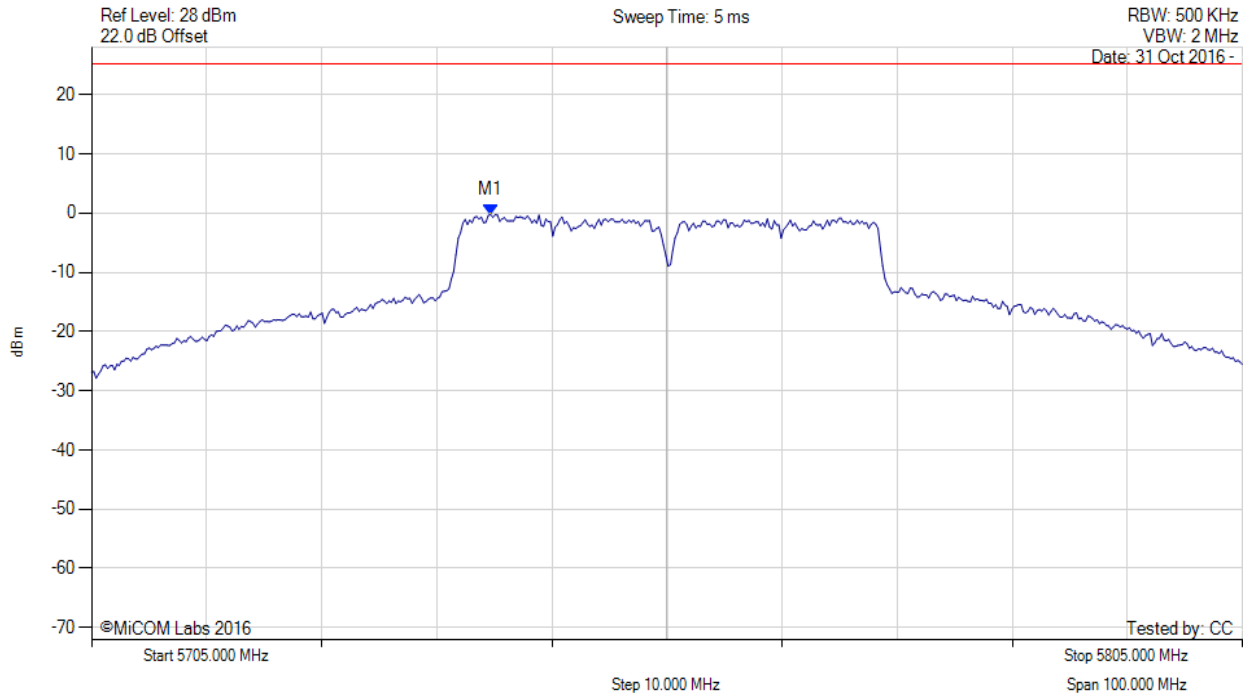

Analyzer Setup	Marker:Frequency:Amplitude	Test Results
Detector = RMS Sweep Count = 100 RF Atten (dB) = 20 Trace Mode = VIEW	M1 : 5739.669 MHz : -0.225 dBm	Limit: ≤ 25.230 dBm

[back to matrix](#)

This test report may be reproduced in full only. The document may only be updated by MiCOM Labs personnel. Any changes will be noted in the Document History section of the report.



Title: NetScout Systems Inc. SENSOR4 Product Family
To: FCC CFR 47 Part 15 Subpart E 15.407 & IC RSS-247
Serial #: NTCT77-U4 Rev B
Issue Date: 12th December 2016
Page: 123 of 128

POWER SPECTRAL DENSITY



Variant: 802.11n HT-40, Channel: 5755.00 MHz, SUM, Temp: 20, Voltage: 48 Vdc

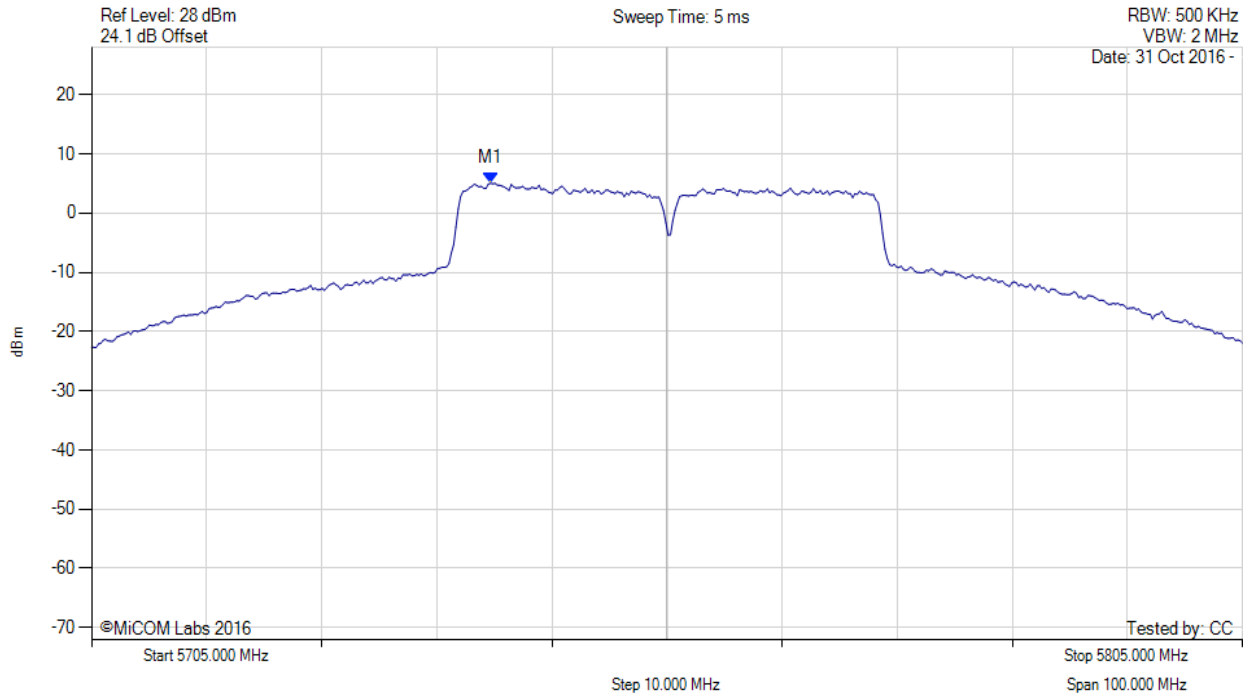

Analyzer Setup	Marker:Frequency:Amplitude	Test Results
Detector = RMS Sweep Count = 100 RF Atten (dB) = 20 Trace Mode = VIEW	M1 : 5739.700 MHz : 5.039 dBm M1 + DCCF : 5739.700 MHz : 5.083 dBm Duty Cycle Correction Factor : +0.04 dB	Limit: ≤ 30.0 dBm Margin: -24.9 dB

[back to matrix](#)

This test report may be reproduced in full only. The document may only be updated by MiCOM Labs personnel. Any changes will be noted in the Document History section of the report.



Title: NetScout Systems Inc. SENSOR4 Product Family
To: FCC CFR 47 Part 15 Subpart E 15.407 & IC RSS-247
Serial #: NTCT77-U4 Rev B
Issue Date: 12th December 2016
Page: 124 of 128

POWER SPECTRAL DENSITY



Variant: 802.11n HT-40, Channel: 5795.00 MHz, Chain a, Temp: 20, Voltage: 48 Vdc

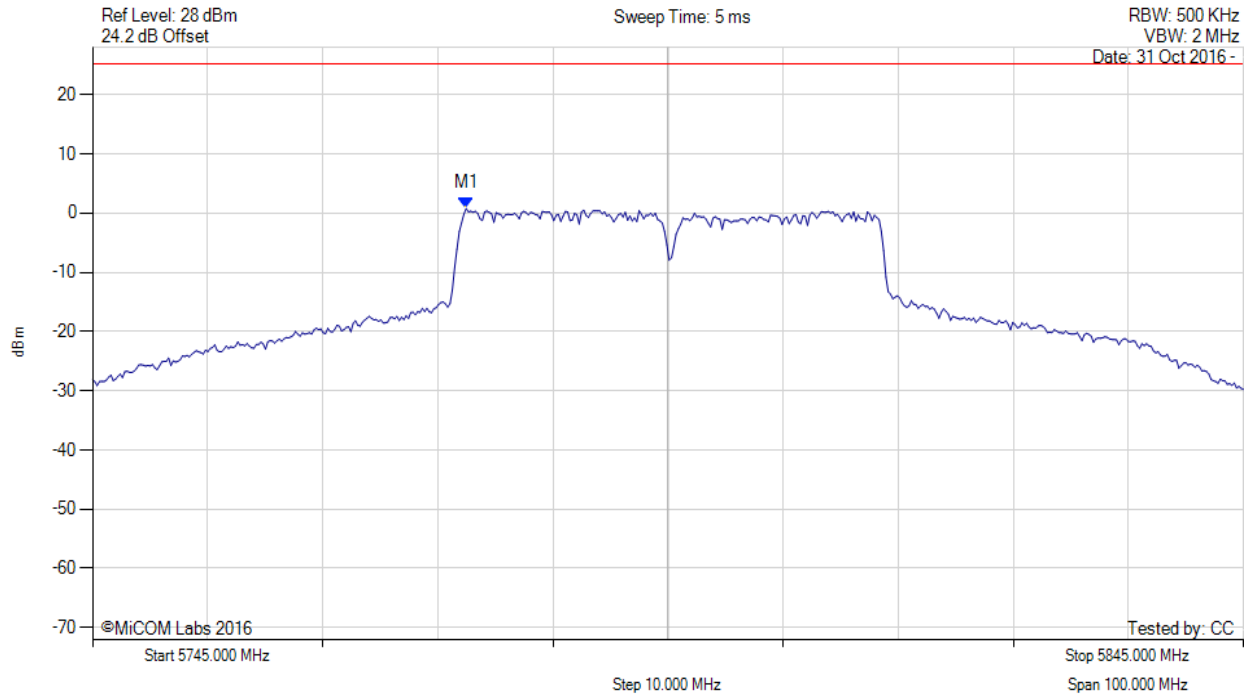

Analyzer Setup	Marker:Frequency:Amplitude	Test Results
Detector = RMS Sweep Count = 100 RF Atten (dB) = 20 Trace Mode = VIEW	M1 : 5777.465 MHz : 0.769 dBm	Limit: ≤ 25.230 dBm

[back to matrix](#)

This test report may be reproduced in full only. The document may only be updated by MiCOM Labs personnel. Any changes will be noted in the Document History section of the report.



Title: NetScout Systems Inc. SENSOR4 Product Family
To: FCC CFR 47 Part 15 Subpart E 15.407 & IC RSS-247
Serial #: NTCT77-U4 Rev B
Issue Date: 12th December 2016
Page: 125 of 128

POWER SPECTRAL DENSITY



Variant: 802.11n HT-40, Channel: 5795.00 MHz, Chain b, Temp: 20, Voltage: 48 Vdc

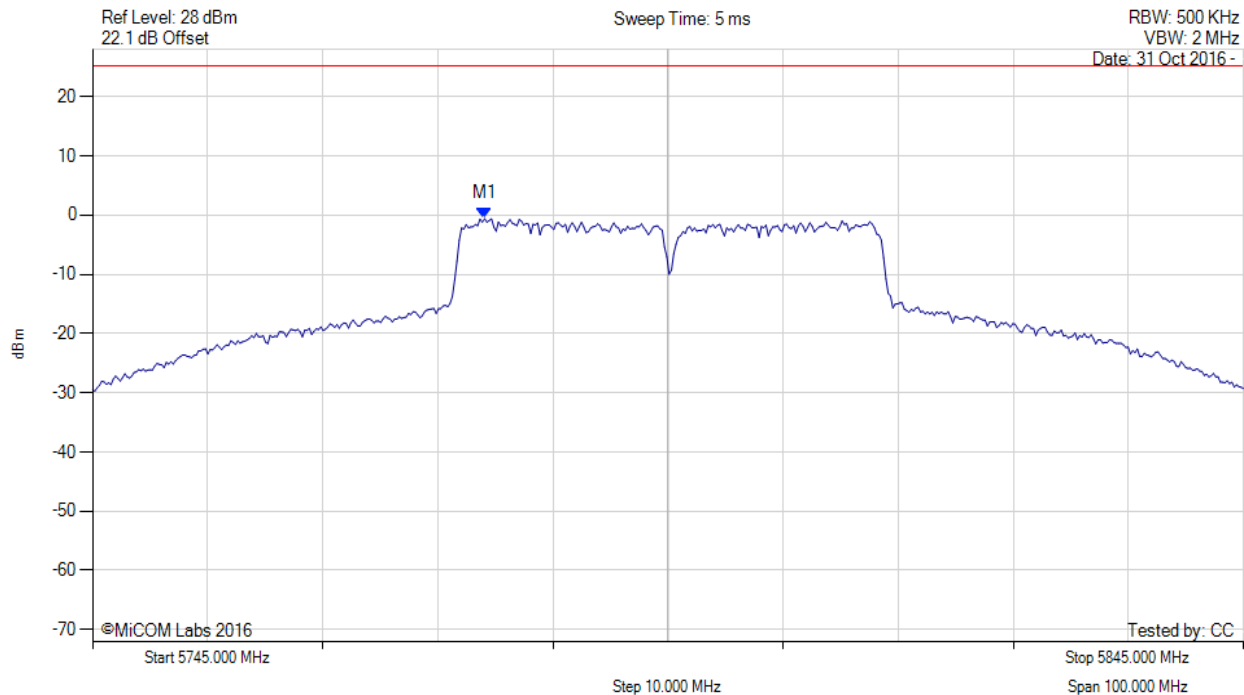

Analyzer Setup	Marker:Frequency:Amplitude	Test Results
Detector = RMS Sweep Count = 100 RF Atten (dB) = 20 Trace Mode = VIEW	M1 : 5779.068 MHz : -0.605 dBm	Limit: ≤ 25.230 dBm

[back to matrix](#)

This test report may be reproduced in full only. The document may only be updated by MiCOM Labs personnel. Any changes will be noted in the Document History section of the report.



Title: NetScout Systems Inc. SENSOR4 Product Family
To: FCC CFR 47 Part 15 Subpart E 15.407 & IC RSS-247
Serial #: NTCT77-U4 Rev B
Issue Date: 12th December 2016
Page: 126 of 128



POWER SPECTRAL DENSITY

Variant: 802.11n HT-40, Channel: 5795.00 MHz, Chain c, Temp: 20, Voltage: 48 Vdc

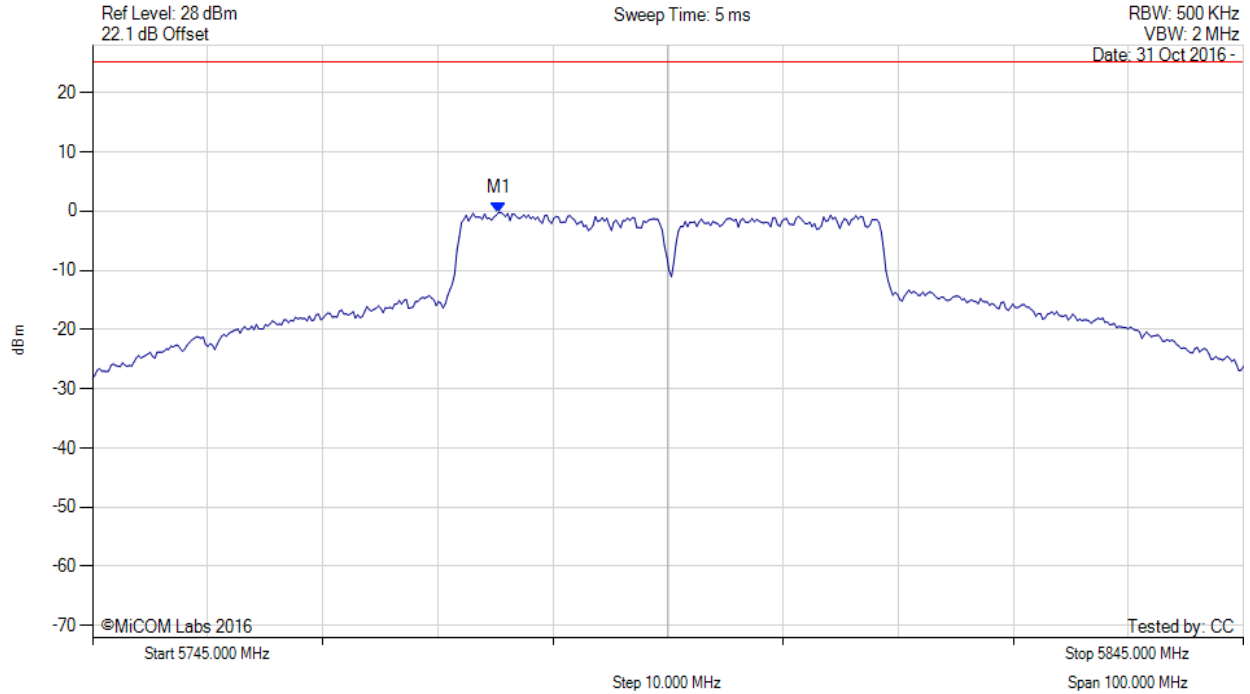

Analyzer Setup	Marker:Frequency:Amplitude	Test Results
Detector = RMS Sweep Count = 100 RF Atten (dB) = 20 Trace Mode = VIEW	M1 : 5780.271 MHz : -0.251 dBm	Limit: ≤ 25.230 dBm

[back to matrix](#)

This test report may be reproduced in full only. The document may only be updated by MiCOM Labs personnel. Any changes will be noted in the Document History section of the report.



Title: NetScout Systems Inc. SENSOR4 Product Family
To: FCC CFR 47 Part 15 Subpart E 15.407 & IC RSS-247
Serial #: NTCT77-U4 Rev B
Issue Date: 12th December 2016
Page: 127 of 128

POWER SPECTRAL DENSITY



Variant: 802.11n HT-40, Channel: 5795.00 MHz, SUM, Temp: 20, Voltage: 48 Vdc

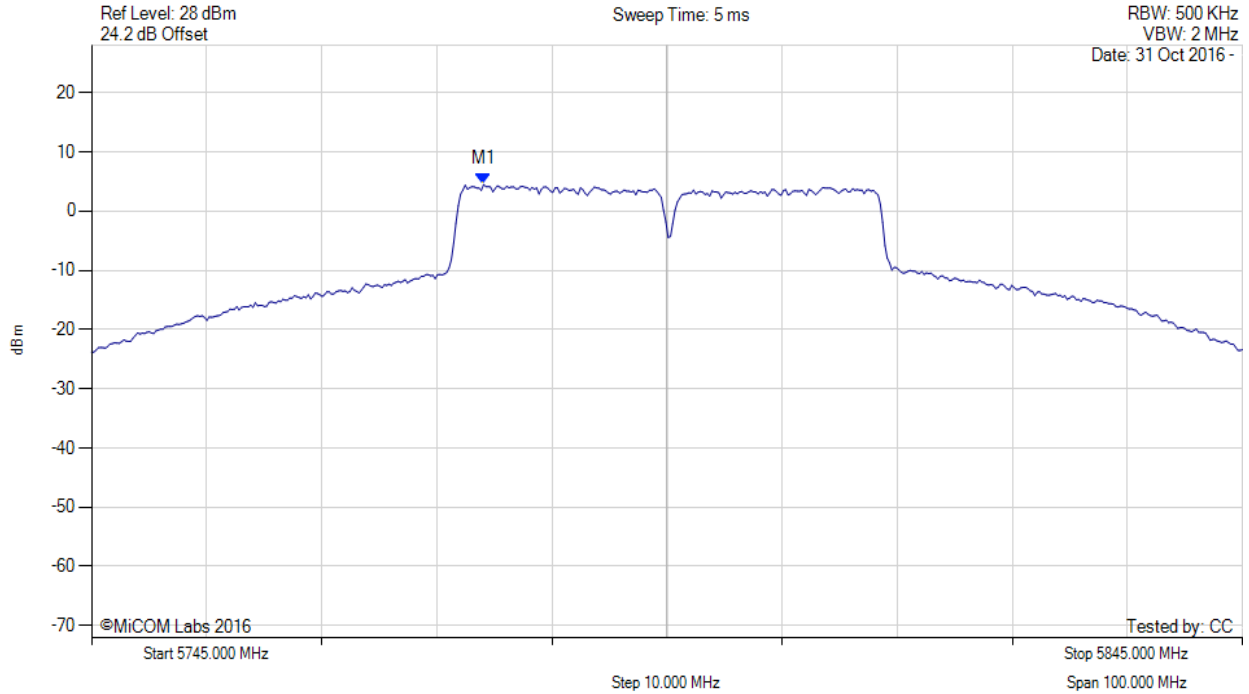

Analyzer Setup	Marker:Frequency:Amplitude	Test Results
Detector = RMS Sweep Count = 100 RF Atten (dB) = 20 Trace Mode = VIEW	M1 : 5779.100 MHz : 4.503 dBm M1 + DCCF : 5779.100 MHz : 4.547 dBm Duty Cycle Correction Factor : +0.04 dB	Limit: ≤ 30.0 dBm Margin: -25.4 dB

[back to matrix](#)

This test report may be reproduced in full only. The document may only be updated by MiCOM Labs personnel. Any changes will be noted in the Document History section of the report.



575 Boulder Court
Pleasanton, California 94566, USA
Tel: +1 (925) 462 0304
Fax: +1 (925) 462 0306
www.micomlabs.com