



FCC RADIO TEST REPORT

FCC ID : PY7-38061M
Equipment : GSM/WCDMA/LTE/5G Phone with BT, DTS/UNII a/b/g/n/ac/ax, GPS and NFC
Brand Name : Sony
Applicant : Sony Corporation
1-7-1 Konan Minato-ku Tokyo, 108-0075 Japan
Manufacturer : Sony Corporation
1-7-1 Konan Minato-ku Tokyo, 108-0075 Japan
Standard : FCC Part 15 Subpart C §15.247

The product was received on Apr. 21, 2021 and testing was started from May 03, 2021 and completed on May 21, 2021. We, Sporton International Inc. EMC & Wireless Communications Laboratory, would like to declare that the tested sample has been evaluated in accordance with the test procedures and has been in compliance with the applicable technical standards.

The test results in this spot check data report apply exclusively to the tested model / sample. Without written approval of Sporton International Inc. EMC & Wireless Communications Laboratory, the test report shall not be reproduced except in full.

Louis Wu

Approved by: Louis Wu

Sporton International Inc. EMC & Wireless Communications Laboratory

No. 52, Huaya 1st Rd., Guishan Dist., Taoyuan City 333, Taiwan (R.O.C.)



Table of Contents

History of this test report.....	3
Summary of Test Result.....	4
1 General Description.....	5
1.1 Product Feature of Equipment Under Test.....	5
1.2 Modification of EUT	5
1.3 Testing Location	6
1.4 Applicable Standards.....	6
2 Test Configuration of Equipment Under Test	7
2.1 Carrier Frequency Channel	7
2.2 Test Mode.....	8
2.3 Connection Diagram of Test System.....	8
2.4 EUT Operation Test Setup	8
3 Test Result.....	9
3.1 Output Power Measurement.....	9
3.2 Radiated Band Edges and Spurious Emission Measurement	10
3.3 Antenna Requirements	14
4 List of Measuring Equipment	15
5 Uncertainty of Evaluation.....	16
Appendix A. Conducted Test Results	
Appendix B. Radiated Spurious Emission	
Appendix C. Radiated Spurious Emission Plots	
Appendix D. Duty Cycle Plots	



History of this test report

Report No.	Version	Description	Issued Date
FR133140B	01	Initial issue of report	May 24, 2021



Summary of Test Result

Report Clause	Ref Std. Clause	Test Items	Result (PASS/FAIL)	Remark
-	15.247(a)(2)	6dB Bandwidth	-	See Note
-	2.1049	99% Occupied Bandwidth	-	See Note
3.1	15.247(b)(3)	Output Power	Pass	-
-	15.247(e)	Power Spectral Density	-	See Note
-	15.247(d)	Conducted Band Edges and Spurious Emission	-	See Note
3.2	15.247(d)	Radiated Band Edges and Spurious Emission	Pass	Under limit 3.38 dB at 18000.000 MHz
-	15.207	AC Conducted Emission	-	See Note
3.3	15.203 & 15.247(b)	Antenna Requirement	Pass	-

Note: The RF circuit, output power level and antenna performance is the same in Bluetooth - LE function across all two FCC ID PY7-38061M and PY7-45256F, since the change, only verify RF output power and radiated spurious emission test data the worst mode was reported in this report.

Declaration of Conformity: The test results with all measurement uncertainty excluded are presented in accordance with the regulation limits or requirements declared by manufacturers.
Comments and Explanations: The declared of product specification for EUT presented in the report are provided by the manufacturer, and the manufacturer takes all the responsibilities for the accuracy of product specification.

Reviewed by: Keven Cheng
Report Producer: Lucy Wu



1 General Description

1.1 Product Feature of Equipment Under Test

GSM/WCDMA/LTE, Bluetooth, DTS/UNII a/b/g/n/ac/ax, NFC, FM Receiver, and GNSS.

Product Specification subjective to this standard	
Antenna Type / Gain	<Ant. 0>: Loop Type Antenna with gain -2.3 dBi <Ant. 1>: Loop Type Antenna with gain -7.0 dBi

Remark: The above EUT's information was declared by manufacturer. Please refer to Comments and Explanations in report summary.

EUT Information List			
HW Version	SW Version	S/N	Performed Test Item
A	0.325	QV7200607L	RF conducted measurement
		QV72002Q7L	Radiated Spurious Emission

Accessory List	
AC Adapter	Model Name : XQZ-UC1
	S/N: 0020W51300039
Earphone	Model Name : STH40D
	S/N : N/A
USB Cable	Model Name : XQZ-UB1
	S/N : N/A

Note:

1. Above EUT list used are electrically identical per declared by manufacturer.
2. Above the accessories list are used to exercise the EUT during test, and the serial number of each type of accessories is listed in each section of this report. .
3. For other wireless features of this EUT, test report will be issued separately.

1.2 Modification of EUT

No modifications are made to the EUT during all test items.



1.3 Testing Location

Test Site	Sporton International Inc. EMC & Wireless Communications Laboratory
Test Site Location	No.52, Huaya 1st Rd., Guishan Dist., Taoyuan City 333, Taiwan (R.O.C.) TEL: +886-3-327-3456 FAX: +886-3-328-4978
Test Site No.	Sporton Site No. TH02-HY

Test Site	Sporton International Inc. Wensan Laboratory
Test Site Location	No.58, Aly. 75, Ln. 564, Wenhua 3rd, Rd., Guishan Dist., Taoyuan City 333010, Taiwan (R.O.C.) TEL: +886-3-327-0868 FAX: +886-3-327-0855
Test Site No.	Sporton Site No. 03CH15-HY (TAF Code: 3786)
Remark	The Radiated Spurious Emission test item subcontracted to Sporton International Inc. Wensan Laboratory

Note: The test site complies with ANSI C63.4 2014 requirement.

FCC designation No.: TW1190 and TW3786

1.4 Applicable Standards

According to the specifications of the manufacturer, the EUT must comply with the requirements of the following standards:

- ♦ FCC Part 15 Subpart C §15.247
- ♦ FCC KDB Publication No. 558074 D01 DTS Meas. Guidance v05r02
- ♦ FCC KDB 414788 D01 Radiated Test Site v01r01
- ♦ ANSI C63.10-2013

Remark:

1. All test items were verified and recorded according to the standards and without any deviation during the test.
2. The TAF code is not including all the FCC KDB listed without accreditation.
3. This EUT has also been tested and complied with the requirements of FCC Part 15, Subpart B, recorded in a separate test report.



2 Test Configuration of Equipment Under Test

2.1 Carrier Frequency Channel

Frequency Band	Channel	Freq. (MHz)	Channel	Freq. (MHz)
2400-2483.5 MHz	0	2402	21	2444
	1	2404	22	2446
	2	2406	23	2448
	3	2408	24	2450
	4	2410	25	2452
	5	2412	26	2454
	6	2414	27	2456
	7	2416	28	2458
	8	2418	29	2460
	9	2420	30	2462
	10	2422	31	2464
	11	2424	32	2466
	12	2426	33	2468
	13	2428	34	2470
	14	2430	35	2472
	15	2432	36	2474
	16	2434	37	2476
	17	2436	38	2478
	18	2438	39	2480
	19	2440	-	-
20	2442	-	-	

2.2 Test Mode

- a. The EUT has been associated with peripherals and configuration operated in a manner tended to maximize its emission characteristics in a typical application. Frequency range investigated: radiation emission (9 kHz to the 10th harmonic of the highest fundamental frequency or to 40 GHz, whichever is lower). For radiated measurement, pre-scanned in three orthogonal panels, X, Y, Z. The worst cases (X plane) were recorded in this report.

The following summary table is showing all test modes to demonstrate in compliance with the standard.

Summary table of Test Cases	
Test Item	Data Rate / Modulation
	Bluetooth – LE / GFSK
Radiated Test Cases	Mode 1: Bluetooth Tx CH00_2402 MHz_2Mbps
	Mode 2: Bluetooth Tx CH39_2480 MHz_2Mbps

Remark: For radiation spurious emission, the final modulation and the worst data rate was reference the original report worse case.

2.3 Connection Diagram of Test System

<Bluetooth-LE Tx Mode>

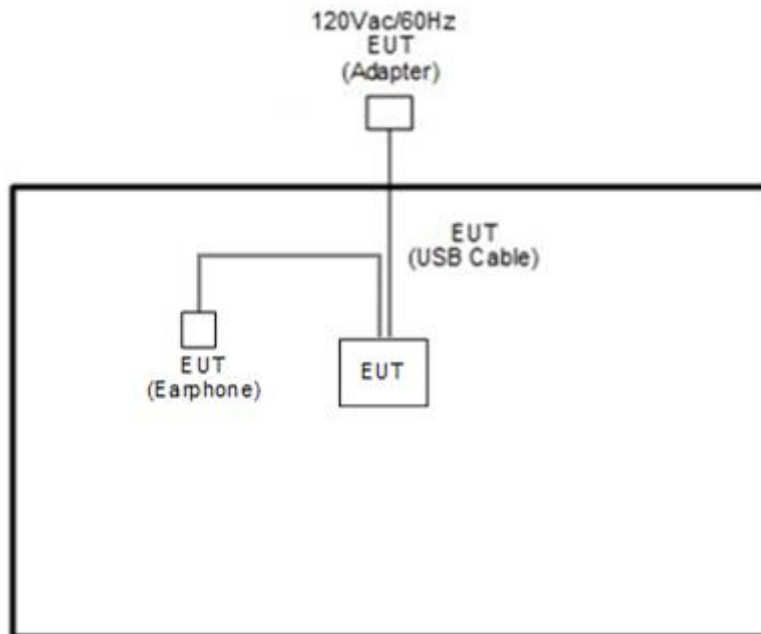

2.4 EUT Operation Test Setup

The RF test items, utility “FTMC_bridge V_0.39 was installed in Notebook which was programmed in order to make the EUT get into the engineering modes to provide channel selection, power level, data rate and the application type and for continuous transmitting signals.

3 Test Result

3.1 Output Power Measurement

3.1.1 Limit of Output Power

For systems using digital modulation in the 2400-2483.5 MHz, the limit for output power is 30 dBm. If transmitting antenna of directional gain greater than 6 dBi is used, the peak output power from the intentional radiator shall be reduced below the above stated value by the amount in dB that the directional gain of the antenna exceeds 6 dBi. In case of point-to-point operation, the limit has to be reduced by 1 dB for every 3 dB that the directional gain of the antenna exceeds 6 dBi.

3.1.2 Measuring Instruments

See list of measuring equipment of this test report.

3.1.3 Test Procedures

1. For Average Power, the testing follows ANSI C63.10 Section 11.9.2.3.2 Method AVGP-M-G
2. The RF output of EUT was connected to the power meter by RF cable and attenuator.
3. The path loss was compensated to the results for each measurement.
4. Set the maximum power setting and enable the EUT to transmit continuously.
5. Measure the conducted output power and record the results in the test report.

3.1.4 Test Setup

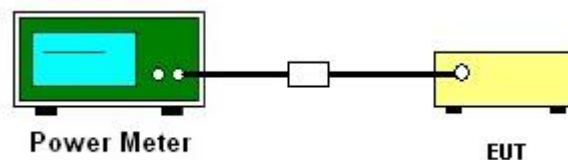

3.1.5 Test Result of Average Output Power

Please refer to Appendix A.



3.2 Radiated Band Edges and Spurious Emission Measurement

3.2.1 Limit of Radiated Band Edges and Spurious Emission

In any 100 kHz bandwidth outside the intentional radiator frequency band, all harmonics/spurious must be at least 20 dB below the highest emission level within the authorized band. If the output power of this device was measured by spectrum analyzer, the attenuation under this paragraph shall be 30 dB instead of 20 dB. In addition, radiated emissions which fall in the restricted bands must also comply with the limits as below.

Frequency (MHz)	Field Strength (microvolts/meter)	Measurement Distance (meters)
0.009 – 0.490	2400/F(kHz)	300
0.490 – 1.705	24000/F(kHz)	30
1.705 – 30.0	30	30
30 – 88	100	3
88 – 216	150	3
216 - 960	200	3
Above 960	500	3

3.2.2 Measuring Instruments

See list of measuring equipment of this test report.



3.2.3 Test Procedures

1. The testing follows the ANSI C63.10 Section 11.12.1 Radiated emission measurements.
2. The EUT was arranged to its worst case and then tune the antenna tower (from 1 m to 4 m) and turntable (from 0 degree to 360 degrees) to find the maximum reading. A pre-amp and a high pass filter are used for the test in order to get better signal level.
3. The EUT was placed on a turntable with 0.8 meter for frequency below 1 GHz and 1.5 meter for frequency above 1 GHz respectively above ground.
4. The EUT was set 3 meters from the interference receiving antenna, which was mounted on the top of a variable height antenna tower.
5. Corrected Reading: Antenna Factor + Cable Loss + Read Level - Preamp Factor = Level
6. For testing below 1 GHz, if the emission level of the EUT in peak mode was 3 dB lower than the limit specified, then peak values of EUT will be reported, otherwise, the emissions will be repeated one by one using the CISPR quasi-peak method and be reported.
7. For testing above 1 GHz, the emission level of the EUT in peak mode was 20 dB lower than average limit (that means the emission level in average mode also complies with the limit in average mode), then peak values of EUT will be reported, otherwise, the emissions will be measured in average mode again and be reported.
8. Use the following spectrum analyzer settings:
 - (1) Span shall wide enough to fully capture the emission being measured;
 - (2) Set RBW = 100 kHz for $f < 1$ GHz; VBW \geq RBW; Sweep = auto; Detector function = peak; Trace = max hold;
 - (3) Set RBW = 1 MHz, VBW = 3 MHz for $f \geq 1$ GHz for peak measurement.
For average measurement:
 - VBW = 10 Hz, when duty cycle is no less than 98 percent.
 - VBW $\geq 1/T$, when duty cycle is less than 98 percent where T is the minimum transmission duration over which the transmitter is on and is transmitting at its maximum power control level for the tested mode of operation.

3.2.4 Test Setup

For radiated test below 30MHz

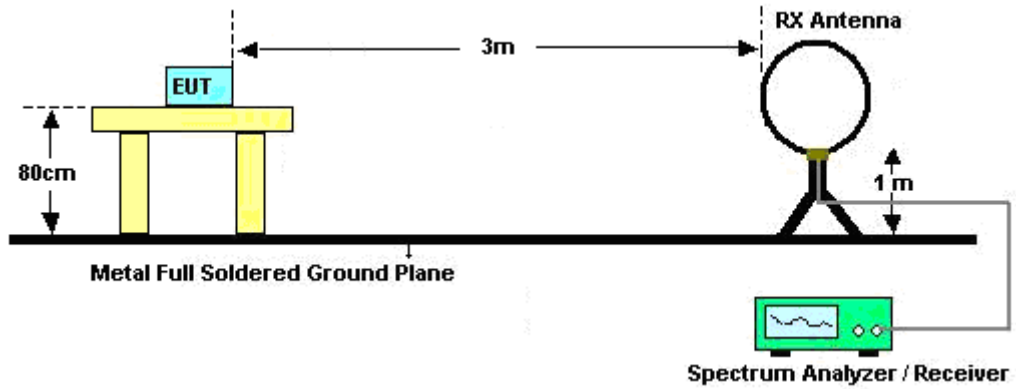

For radiated test from 30MHz to 1GHz

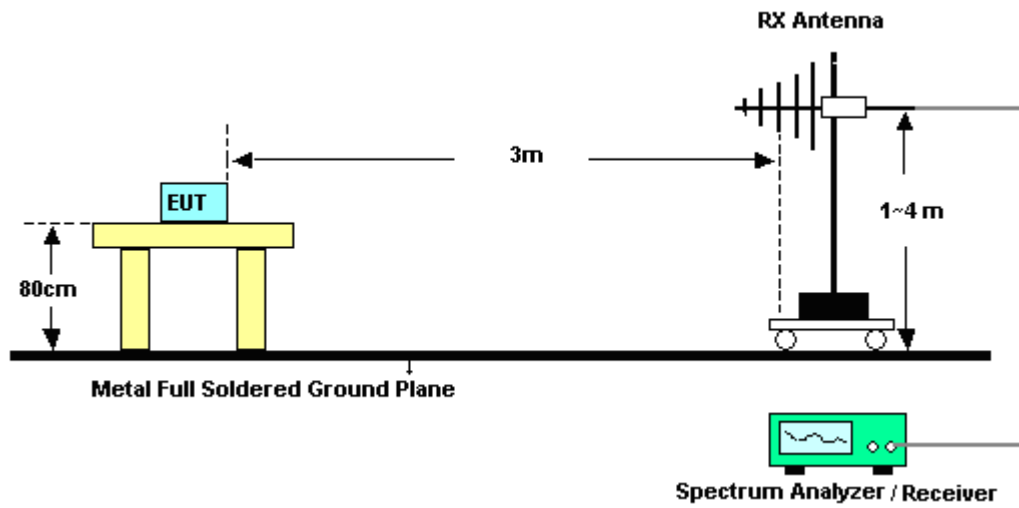

For radiated test from 1GHz to 18GHz

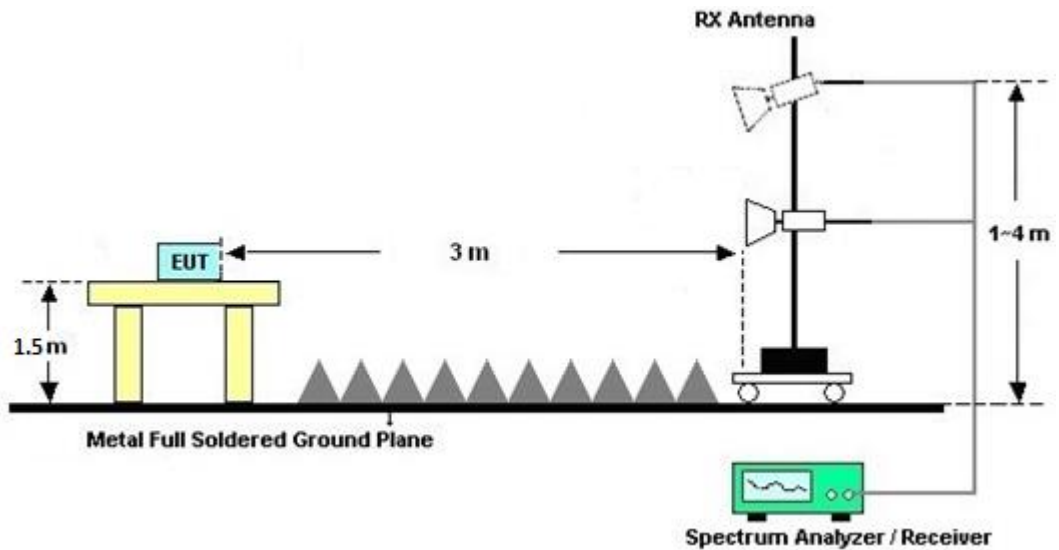

For radiated test above 18GHz

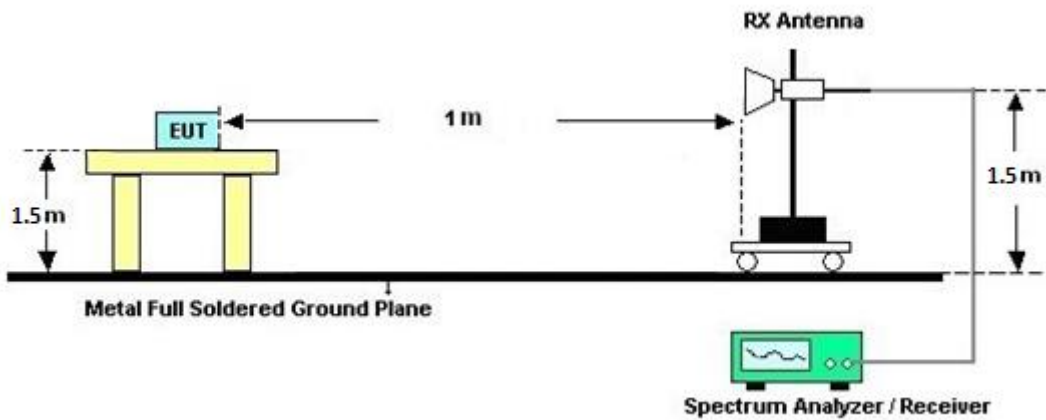

3.2.5 Test Results of Radiated Spurious Emissions (9 kHz ~ 30 MHz)

The low frequency, which started from 9 kHz to 30MHz, was pre-scanned and the result which was 20dB lower than the limit line was not reported.

There is a comparison data of both open-field test site and alternative test site - semi-Anechoic chamber according to 414788 D01 Radiated Test Site v01r01, and the result came out very similar.

3.2.6 Test Result of Radiated Spurious at Band Edges

Please refer to Appendix B and C.

3.2.7 Duty Cycle

Please refer to Appendix D.

3.2.8 Test Result of Radiated Spurious Emission (30 MHz ~ 10th Harmonic)

Please refer to Appendix B and C.



3.3 Antenna Requirements

3.3.1 Standard Applicable

If directional gain of transmitting antennas is greater than 6 dBi, the power shall be reduced by the same level in dB comparing to gain minus 6 dBi. The use of a permanently attached antenna or of an antenna that uses a unique coupling to the intentional radiator shall be considered sufficient to comply with the rule.

3.3.2 Antenna Anti-Replacement Construction

An embedded-in antenna design is used.

3.3.3 Antenna Gain

The antenna peak gain of EUT is less than 6 dBi. Therefore, it is not necessary to reduce maximum peak output power limit.



4 List of Measuring Equipment

Instrument	Brand Name	Model No.	Serial No.	Characteristics	Calibration Date	Test Date	Due Date	Remark
Hygrometer	Testo	608-H1	34893241	N/A	Mar. 02, 2021	May 03, 2021	Mar. 01, 2022	Conducted (TH02-HY)
Power Sensor	DARE	RPR3006W	16100054SN O12	10MHz~6GHz	Dec. 16, 2020	May 03, 2021	Dec. 15, 2021	Conducted (TH02-HY)
Signal Analyzer	Rohde & Schwarz	FSV40	101566	10Hz ~ 40GHz	Jul. 22, 2020	May 03, 2021	Jul. 21, 2021	Conducted (TH02-HY)
Switch Box & RF Cable	EM Electronics	EMSW18SE	SW200302	N/A	Mar. 17, 2021	May 03, 2021	Mar. 16, 2022	Conducted (TH02-HY)
Loop Antenna	Rohde & Schwarz	HFH2-Z2	100488	9 kHz~30 MHz	Jul. 14, 2020	May 08, 2021~ May 21, 2021	Jul. 13, 2021	Radiation (03CH15-HY)
Bilog Antenna	TESEQ	CBL 6111D & 00800N1D01 N-06	41912 & 05	30MHz~1GHz	Feb. 08, 2021	May 08, 2021~ May 21, 2021	Feb. 07, 2022	Radiation (03CH15-HY)
Amplifier	SONOMA	310N	363440	9kHz~1GHz	Dec. 28, 2020	May 08, 2021~ May 21, 2021	Dec. 27, 2021	Radiation (03CH15-HY)
Horn Antenna	SCHWARZB ECK	BBHA 9120 D	9120D-0162 0	1GHz~18GHz	Nov. 03, 2020	May 08, 2021~ May 21, 2021	Nov. 02, 2021	Radiation (03CH15-HY)
SHF-EHF Horn Antenna	SCHWARZB ECK	BBHA 9170	BBHA91702 51	18GHz~40GHz	Dec. 02, 2020	May 08, 2021~ May 21, 2021	Dec. 01, 2021	Radiation (03CH15-HY)
Preamplifier	Jet-Power	JPA0118-55-303	1710001800 055006	1GHz~18GHz	May 06, 2021	May 08, 2021~ May 21, 2021	May 05, 2022	Radiation (03CH15-HY)
Preamplifier	Keysight	83017A	MY53270195	1GHz~26.5GHz	Aug. 21, 2020	May 08, 2021~ May 21, 2021	Aug. 20, 2021	Radiation (03CH15-HY)
Preamplifier	EMEC	EM18G40G	0600789	18-40GHz	Oct. 27, 2020	May 08, 2021~ May 21, 2021	Oct. 26, 2021	Radiation (03CH15-HY)
EMI Test Receiver	Keysight	N9038A(MX E)	MY54130085	20MHz~8.4GHz	Nov. 02, 2020	May 08, 2021~ May 21, 2021	Nov. 01, 2021	Radiation (03CH15-HY)
Spectrum Analyzer	Keysight	N9010A	MY54200485	10Hz~44GHz	Mar. 05, 2021	May 08, 2021~ May 21, 2021	Mar. 04, 2022	Radiation (03CH15-HY)
Antenna Mast	ChainTek	MBS-520-1	N/A	1m~4m	N/A	May 08, 2021~ May 21, 2021	N/A	Radiation (03CH15-HY)
Turn Table	ChainTek	T-200-S-1	N/A	0~360 Degree	N/A	May 08, 2021~ May 21, 2021	N/A	Radiation (03CH15-HY)
Software	Audix	E3 6.2009-8-24(k5)	RK-000451	N/A	N/A	May 08, 2021~ May 21, 2021	N/A	Radiation (03CH15-HY)
RF Cable	HUBER + SUHNER	SUCOFLEX 104, 102E	MY36980/4, MY9838/4PE ,508405/2E	30MHz~18G	Nov. 16, 2020	May 08, 2021~ May 21, 2021	Nov. 15, 2021	Radiation (03CH15-HY)
RF Cable	HUBER + SUHNER	SUCOFLEX 102	505134/2	30MHz-40GHz	Feb. 22, 2021	May 08, 2021~ May 21, 2021	Feb. 21, 2022	Radiation (03CH15-HY)
RF Cable	HUBER + SUHNER	SUCOFLEX 102	800740/2	30MHz-40GHz	Feb. 22, 2021	May 08, 2021~ May 21, 2021	Feb. 21, 2022	Radiation (03CH15-HY)
RF Cable	HUBER + SUHNER	SUCOFLEX 104	MY9837/4PE	9kHz~30MHz	Mar. 11, 2021	May 08, 2021~ May 21, 2021	Mar. 10, 2022	Radiation (03CH15-HY)
Filter	Wainwright	WLJ4-1000-1 530-6000-40 ST	SN4	1.53GHz Low Pass Filter	Jul. 03, 2020	May 08, 2021~ May 21, 2021	Jul. 02, 2021	Radiation (03CH15-HY)
Filter	Wainwright	WHKX12-27 00-3000-180 00-60ST	SN4	3GHz High Pass Filter	Sep. 16, 2020	May 08, 2021~ May 21, 2021	Sep. 15, 2021	Radiation (03CH15-HY)



5 Uncertainty of Evaluation

Uncertainty of Radiated Emission Measurement (30 MHz ~ 1000 MHz)

Measuring Uncertainty for a Level of Confidence of 95% ($U = 2Uc(y)$)	4.7
-------------------------------------------------------------------------	-----

Uncertainty of Radiated Emission Measurement (1000 MHz ~ 18000 MHz)

Measuring Uncertainty for a Level of Confidence of 95% ($U = 2Uc(y)$)	5.3
-------------------------------------------------------------------------	-----

Uncertainty of Radiated Emission Measurement (18000 MHz ~ 40000 MHz)

Measuring Uncertainty for a Level of Confidence of 95% ($U = 2Uc(y)$)	4.9
-------------------------------------------------------------------------	-----

Appendix A. Test Result of Conducted Test Items

Test Engineer:	Eason Huang	Temperature:	21~25	°C
Test Date:	2021/5/3	Relative Humidity:	51~54	%

<Ant. 0>

TEST RESULTS DATA
Average Power Table

Mod.	Data Rate	N _{TX}	CH.	Freq. (MHz)	Average Conducted Power (dBm)
BLE	1Mbps	1	0	2402	8.40
BLE	1Mbps	1	19	2440	8.40
BLE	1Mbps	1	39	2480	8.50

TEST RESULTS DATA
Average Power Table

Mod.	Data Rate	NTX	CH.	Freq. (MHz)	Average Conducted Power (dBm)
BLE	2Mbps	1	0	2402	8.60
BLE	2Mbps	1	19	2440	8.60
BLE	2Mbps	1	39	2480	8.70

<Ant. 1>

TEST RESULTS DATA
Average Power Table

Mod.	Data Rate	NTX	CH.	Freq. (MHz)	Average Conducted Power (dBm)
BLE	1Mbps	1	0	2402	8.30
BLE	1Mbps	1	19	2440	8.30
BLE	1Mbps	1	39	2480	8.40

TEST RESULTS DATA
Average Power Table

Mod.	Data Rate	NTX	CH.	Freq. (MHz)	Average Conducted Power (dBm)
BLE	2Mbps	1	0	2402	8.50
BLE	2Mbps	1	19	2440	8.50
BLE	2Mbps	1	39	2480	8.60



Appendix B. Radiated Spurious Emission

Test Engineer :	Leo Lee, Mancy Chou and Bigshow Wang	Temperature :	22.7~23.7°C
		Relative Humidity :	46~52%

<2Mbps>

2.4GHz 2400~2483.5MHz

BLE (Harmonic @ 3m)

BLE Ant.	Note	Frequency	Level	Over Limit	Limit Line	Read Level	Antenna Factor	Path Loss	Preamp Factor	Ant Pos	Table Pos	Peak Avg.	Pol.
0		(MHz)	(dBμV/m)	(dB)	(dBμV/m)	(dBμV)	(dB/m)	(dB)	(dB)	(cm)	(deg)	(P/A)	(H/V)
BLE CH 39 2480MHz		4960	39.6	-34.4	74	57.19	31.22	10.17	58.98	100	0	P	H
		7440	44.01	-29.99	74	53.52	36.3	12.39	58.2	100	0	P	H
		18000	58.45	-15.55	74	47.8	49	18.89	57.24	100	32	P	H
		18000	50.62	-3.38	54	39.97	49	18.89	57.24	100	32	A	H
		4960	39.37	-34.63	74	56.96	31.22	10.17	58.98	100	0	P	V
		7440	44.42	-29.58	74	53.93	36.3	12.39	58.2	100	0	P	V
		18000	57.91	-16.09	74	47.26	49	18.89	57.24	100	35	P	V
		18000	50.51	-3.49	54	39.86	49	18.89	57.24	100	35	A	V

Remark	1. No other spurious found.
	2. All results are PASS against Peak and Average limit line.



Emission above 18GHz

2.4GHz BLE (SHF)

BLE	Note	Frequency	Level	Over	Limit	Read	Antenna	Path	Preamp	Ant	Table	Peak	Pol.	
Ant.				Limit	Line	Level	Factor	Loss	Factor	Pos	Pos	Avg.		
0		(MHz)	(dBμV/m)	(dB)	(dBμV/m)	(dBμV)	(dB/m)	(dB)	(dB)	(cm)	(deg)	(P/A)	(H/V)	
2.4GHz BLE SHF		21496	39.07	-34.93	74	43.78	38.3	11.69	54.7	150	0	P	H	
													H	
													H	
													H	
													H	
													H	
														H
														H
			21568	38.56	-35.44	74	43.2	38.31	11.75	54.7	150	0	P	V
														V
														V
														V
														V
														V
	Remark	1. No other spurious found. 2. All results are PASS against limit line.												



Emission below 1GHz

2.4GHz BLE (LF)

BLE	Note	Frequency	Level	Over	Limit	Read	Antenna	Path	Preamp	Ant	Table	Peak	Pol.	
Ant.				Limit	Line	Level	Factor	Loss	Factor	Pos	Pos	Avg.		
0		(MHz)	(dBμV/m)	(dB)	(dBμV/m)	(dBμV)	(dB/m)	(dB)	(dB)	(cm)	(deg)	(P/A)	(H/V)	
2.4GHz BLE LF		47.46	27.3	-12.7	40	43.63	15.39	0.87	32.59	100	0	P	H	
		192.96	29.9	-13.6	43.5	45.57	14.77	2.01	32.45	-	-	P	H	
		298.69	25.1	-20.9	46	36.11	19.09	2.39	32.49	-	-	P	H	
		481.05	24.65	-21.35	46	30.53	23.64	3	32.52	-	-	P	H	
		713.85	31.8	-14.2	46	34.03	26.6	3.62	32.45	-	-	P	H	
		856.44	31.72	-14.28	46	30.48	29.03	4.06	31.85	-	-	P	H	
														H
														H
														H
														H
														H
														H
														H
			42.61	33.62	-6.38	40	47.38	18	0.82	32.58	100	0	P	V
			98.87	24.9	-18.6	43.5	40.26	15.71	1.43	32.5	-	-	P	V
			193.93	23.18	-20.32	43.5	38.83	14.78	2.02	32.45	-	-	P	V
			561.56	26.39	-19.61	46	29.65	26.09	3.25	32.6	-	-	P	V
			683.78	27.63	-18.37	46	30.16	26.34	3.55	32.42	-	-	P	V
			790.48	29.75	-16.25	46	30.06	28.04	3.87	32.22	-	-	P	V
														V
													V	
													V	
													V	
													V	
													V	
Remark	1. No other spurious found. 2. All results are PASS against limit line.													



2.4GHz 2400~2483.5MHz

BLE (Band Edge @ 3m)

BLE	Note	Frequency	Level	Over	Limit	Read	Antenna	Path	Preamp	Ant	Table	Peak	Pol.	
Ant.				Limit	Line	Level	Factor	Loss	Factor	Pos	Pos	Avg.		
1		(MHz)	(dBμV/m)	(dB)	(dBμV/m)	(dBμV)	(dB/m)	(dB)	(dB)	(cm)	(deg)	(P/A)	(H/V)	
BLE CH 00 2402MHz		2349.27	54.17	-19.83	74	40.9	27.7	16.5	30.93	118	142	P	H	
		2325.435	44.73	-9.27	54	31.46	27.75	16.46	30.94	118	142	A	H	
	*	2402	97.97	-	-	84.8	27.5	16.58	30.91	118	142	P	H	
	*	2402	96.29	-	-	83.12	27.5	16.58	30.91	118	142	A	H	
													H	
														H
			2377.41	54.36	-19.64	74	41.15	27.59	16.54	30.92	382	308	P	V
			2323.755	43.71	-10.29	54	30.45	27.75	16.45	30.94	382	308	A	V
	*		2402	96.65	-	-	83.48	27.5	16.58	30.91	382	308	P	V
	*		2402	94.97	-	-	81.8	27.5	16.58	30.91	382	308	A	V
														V
														V
Remark	1. No other spurious found. 2. All results are PASS against Peak and Average limit line.													



Note symbol

*	Fundamental Frequency which can be ignored. However, the level of any unwanted emissions shall not exceed the level of the fundamental frequency.
!	Test result is over limit line.
P/A	Peak or Average
H/V	Horizontal or Vertical



A calculation example for radiated spurious emission is shown as below:

BLE	Note	Frequency	Level	Over	Limit	Read	Antenna	Path	Preamp	Ant	Table	Peak	Pol.
		(MHz)	(dBμV/m)	(dB)	(dBμV/m)	(dBμV)	(dB/m)	(dB)	(dB)	(cm)	(deg)	(P/A)	(H/V)
BLE CH 00 2402MHz		2390	55.45	-18.55	74	54.51	32.22	4.58	35.86	103	308	P	H
		2390	43.54	-10.46	54	42.6	32.22	4.58	35.86	103	308	A	H

1. Path Loss(dB) = Cable loss(dB) + Filter loss(dB) + Attenuator loss(dB)
2. Level(dBμV/m) =
Antenna Factor(dB/m) + Path Loss(dB) + Read Level(dBμV) - Preamp Factor(dB)
3. Over Limit(dB) = Level(dBμV/m) – Limit Line(dBμV/m)

For Peak Limit @ 2390MHz:

1. Level(dBμV/m)
= Antenna Factor(dB/m) + Path Loss(dB) + Read Level(dBμV) - Preamp Factor(dB)
= 32.22(dB/m) + 4.58(dB) + 54.51(dBμV) – 35.86 (dB)
= 55.45 (dBμV/m)
2. Over Limit(dB)
= Level(dBμV/m) – Limit Line(dBμV/m)
= 55.45(dBμV/m) – 74(dBμV/m)
= -18.55(dB)

For Average Limit @ 2390MHz:

1. Level(dBμV/m)
= Antenna Factor(dB/m) + Path Loss(dB) + Read Level(dBμV) - Preamp Factor(dB)
= 32.22(dB/m) + 4.58(dB) + 42.6(dBμV) – 35.86 (dB)
= 43.54 (dBμV/m)
2. Over Limit(dB)
= Level(dBμV/m) – Limit Line(dBμV/m)
= 43.54(dBμV/m) – 54(dBμV/m)
= -10.46(dB)

Both peak and average measured complies with the limit line, so test result is “PASS”.



Appendix C. Radiated Spurious Emission Plots

Test Engineer :	Leo Lee, Mancy Chou and Bigshow Wang	Temperature :	22.7~23.7°C
		Relative Humidity :	46~52%

<2Mbps>

2.4GHz 2400~2483.5MHz

BLE (Harmonic @ 3m)

BLE	2.4GHz 2400~2483.5MHz Harmonic @ 3m	
Ant.	BLE CH39 2480MHz	
0	Horizontal	Vertical
Peak	<p>Site : 03CH15-HY Condition : PEAK_74 3m 91200_15_1620 HORIZONTAL Detector : Peak Project : 133140</p>	<p>Site : 03CH15-HY Condition : PEAK_74 3m 91200_15_1620 VERTICAL Detector : Peak Project : 133140</p>

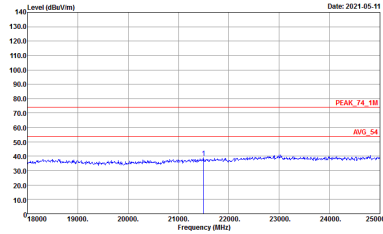
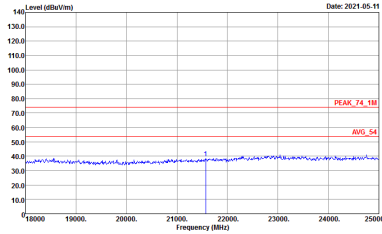

Emission above 18GHz
2.4GHz BLE (SHF)

BLE	2.4GHz 2400~2483.5MHz	
Ant.	BLE SHF	
0	Horizontal	Vertical
<p>QP / Peak</p>	 <p>Site : 03CH16-1FY Condition : PEAK_74_1M 1m SHF HORN BBH49170576 HORIZONTAL Detector : Peak Project : 133140</p>	 <p>Site : 03CH16-1FY Condition : PEAK_74_1M 1m SHF HORN BBH49170576 VERTICAL Detector : Peak Project : 133140</p>

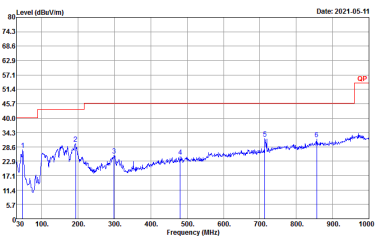
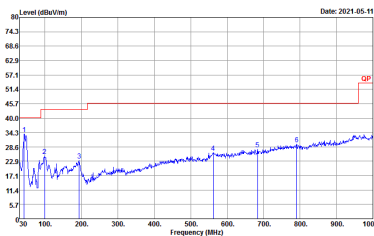

Emission below 1GHz
2.4GHz BLE (LF)

BLE	2.4GHz 2400~2483.5MHz	
Ant.	BLE LF	
0	Horizontal	Vertical
<p>QP / Peak</p>	 <p>Site : 03CH15-HY Condition : QP 3m B1LOG_41912_20210208 HORIZONTAL Detector : Peak Project : 133140</p>	 <p>Site : 03CH15-HY Condition : QP 3m B1LOG_41912_20210208 VERTICAL Detector : Peak Project : 133140</p>



2.4GHz 2400~2483.5MHz
BLE (Band Edge @ 3m)

BLE	2.4GHz 2400~2483.5MHz Band Edge @ 3m	
Ant.	BLE CH00 2402MHz	
1	Horizontal	Fundamental
Peak	<p>Site : 03CH15-HY Condition : PEAK_BE_74 3m 91200_15_1620 HORIZONTAL Detector : Peak Project : 133140</p>	<p>Site : 03CH15-HY Condition : PEAK_74 3m 91200_15_1620 HORIZONTAL Detector : Peak Project : 133140</p>
Avg.	<p>Site : 03CH15-HY Condition : AVG_BE_54 3m 91200_15_1620 HORIZONTAL Detector : Peak Project : 133140</p>	<p>Site : 03CH15-HY Condition : AVG_54 3m 91200_15_1620 HORIZONTAL Detector : Peak Project : 133140</p>

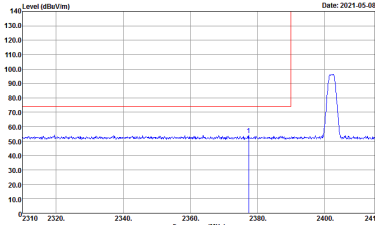
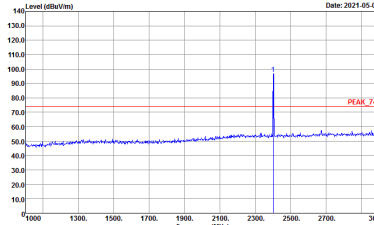
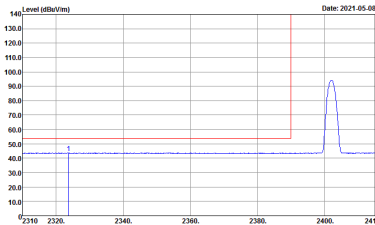
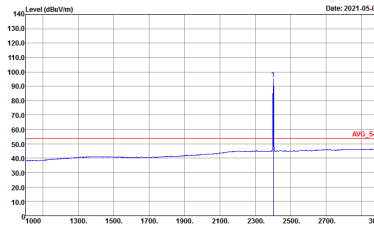

BLE	2.4GHz 2400~2483.5MHz Band Edge @ 3m	
Ant.	BLE CH00 2402MHz	
1	Vertical	Fundamental
Peak	 <p>Date: 2021-05-08</p> <p>Site : 03CH15-HY Condition : PEAK_BE_74 3m 91200_15_1620 VERTICAL RBW:1000.000KHz VBW:3000.000KHz SWT:Auto Detector : Peak Project : 133140</p>	 <p>Date: 2021-05-08</p> <p>Site : 03CH15-HY Condition : PEAK_74 3m 91200_15_1620 VERTICAL RBW:1000.000KHz VBW:3000.000KHz SWT:Auto Detector : Peak Project : 133140</p>
Avg.	 <p>Date: 2021-05-08</p> <p>Site : 03CH15-HY Condition : AVG_BE_54 3m 91200_15_1620 VERTICAL RBW:1000.000KHz VBW:1000KHz SWT:Auto Detector : Peak Project : 133140</p>	 <p>Date: 2021-05-08</p> <p>Site : 03CH15-HY Condition : AVG_54 3m 91200_15_1620 VERTICAL RBW:1000.000KHz VBW:1000KHz SWT:Auto Detector : Peak Project : 133140</p>



Appendix D. Duty Cycle Plots

Antenna	Band	Duty Cycle(%)	T(us)	1/T(kHz)	VBW Setting	Duty Factor(dB)
0	Bluetooth –LE for 2Mbps	57.33	1075	0.93	1kHz	2.42
1	Bluetooth –LE for 2Mbps	57.33	1075	0.93	1kHz	2.42

<Ant. 0>

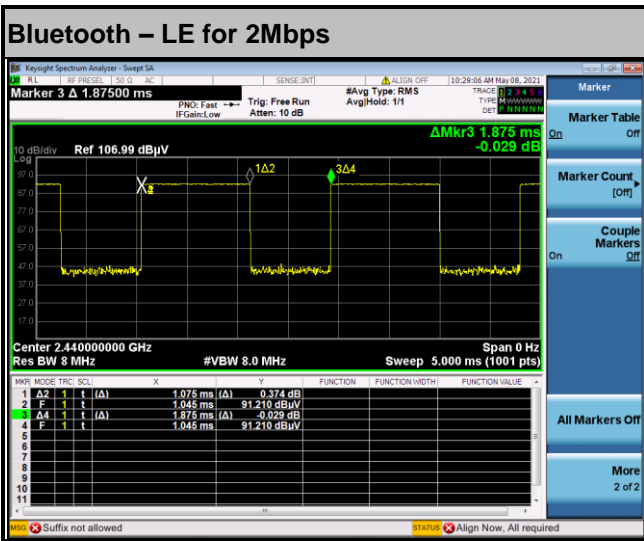

<Ant. 1>

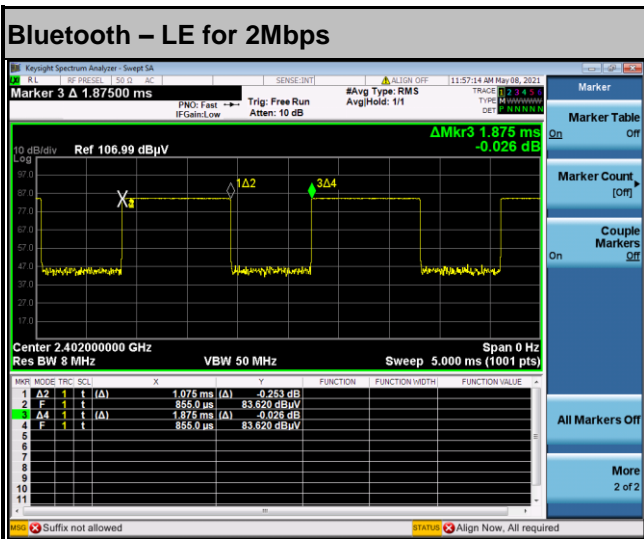

—THE END—