

# FCC RADIO TEST REPORT

**FCC ID** : LDK-SMST9105AXW  
**Equipment** : Catalyst 9105AX 802.11ax Access Point  
**Brand Name** : Cisco  
**Model Name** : C9105AXW-B, C9105AXW-C, C9105AXW-D, C9105AXW-F, C9105AXW-N, C9105AXW-S, C9105AXW-K, C9105AXW-x (Refer to section 1.1.5 for more details)  
**Applicant** : Cisco Systems, Inc.  
125 West Tasman Drive, San Jose, California, United States, 95134-1706  
**Manufacturer** : Cisco Systems, Inc.  
125 West Tasman Drive, San Jose, California, United States, 95134-1706  
**Standard** : 47 CFR FCC Part 15.247

The product was received on Feb. 27, 2020, and testing was started from Mar. 05, 2020 and completed on May 11, 2020. We, SPORTON INTERNATIONAL INC. EMC & Wireless Communications Laboratory, would like to declare that the tested sample has been evaluated in accordance with the procedures given in ANSI C63.10-2013 and shown compliance with the applicable technical standards.

The report must not be used by the client to claim product certification, approval, or endorsement by TAF or any agency of government.

The test results in this report apply exclusively to the tested model / sample. Without written approval of SPORTON INTERNATIONAL INC. EMC & Wireless Communications Laboratory, the test report shall not be reproduced except in full.

  
Approved by: Cliff Chang

**SPORTON INTERNATIONAL INC. EMC & Wireless Communications Laboratory**  
No. 52, Huaya 1st Rd., Guishan Dist., Taoyuan City, Taiwan (R.O.C.)



# Table of Contents

**History of this test report.....3**

**Summary of Test Result.....4**

**1 General Description .....5**

1.1 Information.....5

1.2 Applicable Standards .....9

1.3 Testing Location Information.....9

1.4 Measurement Uncertainty .....9

**2 Test Configuration of EUT .....10**

2.1 Test Channel Mode .....10

2.2 The Worst Case Measurement Configuration.....11

2.3 EUT Operation during Test .....12

2.4 Accessories .....12

2.5 Support Equipment.....13

2.6 Test Setup Diagram .....14

**3 Transmitter Test Result .....16**

3.1 AC Power-line Conducted Emissions .....16

3.2 DTS Bandwidth.....18

3.3 Maximum Conducted Output Power .....19

3.4 Power Spectral Density .....22

3.5 Emissions in Non-restricted Frequency Bands .....24

3.6 Emissions in Restricted Frequency Bands.....25

**4 Test Equipment and Calibration Data .....30**

**Appendix A. Test Results of AC Power-line Conducted Emissions**

**Appendix B. Test Results of DTS Bandwidth**

**Appendix C. Test Results of Maximum Conducted Output Power**

**Appendix D. Test Results of Power Spectral Density**

**Appendix E. Test Results of Emissions in Non-restricted Frequency Bands**

**Appendix F. Test Results of Emissions in Restricted Frequency Bands**

**Appendix G. Test Photos**

**Photographs of EUT v01**



### History of this test report

Report No.	Version	Description	Issued Date
FR992017-02AD	01	Initial issue of report	May 29, 2020



### Summary of Test Result

Report Clause	Ref Std. Clause	Test Items	Result (PASS/FAIL)	Remark
1.1.2	15.203	Antenna Requirement	PASS	-
3.1	15.207	AC Power-line Conducted Emissions	PASS	-
3.2	15.247(a)	DTS Bandwidth	PASS	-
3.3	15.247(b)	Maximum Conducted Output Power	PASS	-
3.4	15.247(e)	Power Spectral Density	PASS	-
3.5	15.247(d)	Emissions in Non-restricted Frequency Bands	PASS	-
3.6	15.247(d)	Emissions in Restricted Frequency Bands	PASS	-

**Declaration of Conformity:**

The test results with all measurement uncertainty excluded are presented in accordance with the regulation limits or requirements declared by manufacturers.

**Comments and Explanations:**

1. The test configuration, test mode and test software were written in this test report are declared by the manufacturer.
2. The declared of product specification for EUT presented in the report are provided by the manufacturer, and the manufacturer takes all the responsibilities for the accuracy of product specification.

Reviewed by: **Sam Chen**  
Report Producer: **Sandy Chuang**



# 1 General Description

## 1.1 Information

### 1.1.1 RF General Information

Frequency Range (MHz)	Bluetooth Mode	Ch. Frequency (MHz)	Channel Number
2400-2483.5	LE	2402-2480	0-39 [40]

Band	Mode	BWch (MHz)	Nant
2.4-2.4835GHz	BT-LE(1Mbps)	1	1TX
2.4-2.4835GHz	BT-LE(500Kb/s)	1	1TX
2.4-2.4835GHz	BT-LE(125Kb/s)	1	1TX
2.4-2.4835GHz	BT-LE(2Mbps)	2	1TX

Note:

- ♦ Bluetooth LE uses a GFSK modulation.
- ♦ BWch is the nominal channel bandwidth.
- ♦ Nss-Min is the minimum number of spatial streams.
- ♦ Nant is the number of outputs. e.g., 2(2, 3) means have 2 outputs for port 2 and port 3. 2 means have 2 outputs for port 1 and port 2.



1.1.2 Antenna Information

Ant.	Port	Brand	Model Name	Antenna Type	Connector	Gain (dBi)
1	1	PEGATRON	WIFI_1 ant	PIFA	I-PEX	Note 1
2	2	PEGATRON	WIFI_2 ant	PIFA	I-PEX	
3	1	PEGATRON	BLE ant	PIFA	I-PEX	

Note 1:

Ant.	Port	WLAN 2.4GHz Gain (dBi)							
		2400 MHz	2412 MHz	2437 MHz	2442 MHz	2450 MHz	2462 MHz	2472 MHz	2500 MHz
1	1	2.02	1.81	2.25	2.37	2.51	2.48	2.20	2.14
2	2	1.55	1.63	2.10	2.23	2.20	2.07	1.75	1.99

Ant.	Port	WLAN 5GHz Gain (dBi)							
		5150 MHz	5250 MHz	5350 MHz	5470 MHz	5500 MHz	5600 MHz	5725 MHz	5850 MHz
1	1	4.91	4.97	4.88	4.93	4.82	4.73	4.78	4.93
2	2	4.58	4.76	4.60	4.41	4.35	4.25	4.40	4.56

Ant.	Port	BT/Zigbee Gain (dBi)							
		2400 MHz	2412 MHz	2437 MHz	2442 MHz	2450 MHz	2462 MHz	2472 MHz	2500 MHz
3	1	2.47	2.45	2.55	2.70	2.69	2.64	2.58	2.62

Note 2: The above information was declared by manufacturer.



Note 3:

**For 2.4GHz function:**

**For IEEE 802.11 b/g/n/ax (1TX/1RX):**

Only Port 1 can be used as transmitting/receiving antenna.

**For IEEE 802.11 b/g/n/ax (2TX/2RX):**

Port 1 and Port 2 can be used as transmitting/receiving antenna.

Port 1 and Port 2 could transmit/receive simultaneously.

**For 5GHz function:**

**For IEEE 802.11a/n/ac/ax (1TX/1RX):**

Only Port 1 can be used as transmitting/receiving antenna.

**For IEEE 802.11a/n/ac/ax (2TX/2RX):**

Port 1 and Port 2 can be used as transmitting/receiving antenna.

Port 1 and Port 2 could transmit/receive simultaneously.

**For Bluetooth function:**

Only Port 1 can be used as transmitting/receiving antenna.

**For Zigbee function:**

Only Port 1 can be used as transmitting/receiving antenna.

### 1.1.3 Mode Test Duty Cycle

Mode	DC	DCF(dB)	T(s)	VBW(Hz) ≥ 1/T
BT-LE(1Mbps)	1	0	n/a (DC>=0.98)	n/a (DC>=0.98)
BT-LE(2Mbps)	1	0	n/a (DC>=0.98)	n/a (DC>=0.98)

Note:

- ◆ DC is Duty Cycle.
- ◆ DCF is Duty Cycle Factor.



1.1.4 EUT Operational Condition

<b>EUT Power Type</b>	From PoE		
<b>Function</b>	<input checked="" type="checkbox"/> Point-to-multipoint	<input type="checkbox"/> Point-to-point	
<b>Test Software Version</b>	17.18.2 (r782430 WLTEST)		
<b>Support Mode</b>	<input checked="" type="checkbox"/>	LE 1M PHY: 1 Mb/s	
	<input checked="" type="checkbox"/>	LE Coded PHY (S=2): 500 Kb/s	
	<input checked="" type="checkbox"/>	LE Coded PHY (S=8): 125 Kb/s	
	<input checked="" type="checkbox"/>	LE 2M PHY: 2 Mb/s	

Note: The above information was declared by manufacturer.

1.1.5 Table for Multiple Listing

The model names in the following table are all refer to the identical product.

Model Name	Description
C9105AXW-B	All the models are identical, the difference model for difference marketing strategy.
C9105AXW-C	
C9105AXW-D	
C9105AXW-F	
C9105AXW-N	
C9105AXW-S	
C9105AXW-K	
C9105AXW-x	
(x can be A-Z, regional country code)	

From the above models, model: C9105AXW-B was selected as representative model for the test and its data was recorded in this report.





## 1.2 Applicable Standards

According to the specifications of the manufacturer, the EUT must comply with the requirements of the following standards:

- ◆ 47 CFR FCC Part 15
- ◆ ANSI C63.10-2013

The following reference test guidance is not within the scope of accreditation of TAF.

- ◆ FCC KDB 558074 D01 v05r02
- ◆ FCC KDB 414788 D01 v01r01

## 1.3 Testing Location Information

Testing Location		
<input type="checkbox"/>	HWA YA	ADD : No. 52, Huaya 1st Rd., Guishan Dist., Taoyuan City, Taiwan (R.O.C.) TEL : 886-3-327-3456 FAX : 886-3-327-0973
<input checked="" type="checkbox"/>	JHUBEI	ADD : No.8, Lane 724, Bo-ai St., Jhubei City, HsinChu County 302, Taiwan, R.O.C. TEL : 886-3-656-9065 FAX : 886-3-656-9085

Test Condition	Test Site No.	Test Engineer	Test Environment	Test Date
RF Conducted	TH01-CB	Owen Hsu	20.5-22°C / 49-53%	Mar. 05, 2020~ Mar. 27, 2020
Radiated (Cabinet)	03CH05-CB	Stim Sun	21.3-23.2°C / 55-58%	Mar. 10, 2020~ May 05, 2020
AC Conduction	CO01-CB	GN Hou	23~24°C / 63~65%	May 11, 2020

Test site Designation No. TW0006 with FCC.

Test site registered number IC 4086D with Industry Canada.

## 1.4 Measurement Uncertainty

ISO/IEC 17025 requires that an estimate of the measurement uncertainties associated with the emissions test results be included in the report. The measurement uncertainties given below are based on a 95% confidence level (based on a coverage factor (k=2))

Test Items	Uncertainty	Remark
Conducted Emission (150kHz ~ 30MHz)	2.0 dB	Confidence levels of 95%
Radiated Emission (30MHz ~ 1,000MHz)	4.3 dB	Confidence levels of 95%
Radiated Emission (1GHz ~ 18GHz)	4.3 dB	Confidence levels of 95%
Radiated Emission (18GHz ~ 40GHz)	5.1 dB	Confidence levels of 95%
Conducted Emission	2.4 dB	Confidence levels of 95%
Output Power Measurement	1.5 dB	Confidence levels of 95%
Power Density Measurement	2.4 dB	Confidence levels of 95%
Bandwidth Measurement	2%	Confidence levels of 95%



## 2 Test Configuration of EUT

### 2.1 Test Channel Mode

Mode	Power Setting
BT-LE(1Mbps)	-
2402MHz	5
2440MHz	5
2480MHz	5
BT-LE(2Mbps)	-
2402MHz	5
2440MHz	5
2480MHz	5



## 2.2 The Worst Case Measurement Configuration

The Worst Case Mode for Following Conformance Tests	
<b>Tests Item</b>	AC power-line conducted emissions
<b>Condition</b>	AC power-line conducted measurement for line and neutral
<b>Operating Mode</b>	CTX
1	EUT_2.4GHz + PoE
2	EUT_5GHz + PoE
3	EUT_Bluetooth LE + PoE
4	EUT_Zigbee + PoE
For operating mode 3 is the worst case and it was record in this test report.	

The Worst Case Mode for Following Conformance Tests	
<b>Tests Item</b>	DTS Bandwidth Maximum Conducted Output Power Power Spectral Density Emissions in Non-restricted Frequency Bands
<b>Test Condition</b>	Conducted measurement at transmit chains

The Worst Case Mode for Following Conformance Tests	
<b>Tests Item</b>	Emissions in Restricted Frequency Bands
<b>Test Condition</b>	Radiated measurement If EUT consist of multiple antenna assembly (multiple antenna are used in EUT regardless of spatial multiplexing MIMO configuration), the radiated test should be performed with highest antenna gain of each antenna type.
<b>Operating Mode &lt; 1GHz</b>	CTX Y-axis generated the worst result for Emissions in Restricted Frequency Bands (above 1GHz), thus the measurement will follow this same test configuration.
1	EUT_2.4GHz + PoE in Y axis
2	EUT_5GHz + PoE in Y axis
3	EUT_Bluetooth LE + PoE in Y axis
4	EUT_Zigbee + PoE in Y axis
For operating mode 2 is the worst case and it was record in this test report.	
<b>Operating Mode &gt; 1GHz</b>	CTX (Cabinet) The EUT was performed at X axis, Y axis and Z axis position. The worst case was found at Y axis, thus the measurement will follow this same test configuration.
1	EUT_Bluetooth LE in Y axis



The Worst Case Mode for Following Conformance Tests	
Tests Item	Simultaneous Transmission Analysis - Co-location RF Exposure Evaluation
Operating Mode	
1	WLAN 2.4GHz + WLAN 5GHz + Bluetooth LE
2	WLAN 2.4GHz + WLAN 5GHz + Zigbee
Refer to Sporton Test Report No.: FA992017-02 for Co-location RF Exposure Evaluation.	

Note: It was supplied power by PoE for EUT, and the PoE is for measurement only, would not be marketed.

<For Conducted emissions and Radiated measurement (below 1GHz)>

Equipment	Brand Name	Model Name	FCC ID
PoE	PHIHONG	POE29U-1AT(PL)	N/A

<For other tests>

Equipment	Brand Name	Model Name	FCC ID
PoE	CERIO	POE-G30	N/A

### 2.3 EUT Operation during Test

The EUT was programmed to be in continuously transmitting mode.

### 2.4 Accessories

Accessories				
No.	Equipment Name	Brand Name	Model Name	Remark
1	Mounting bracket*1	PEGATRON	13BK-30N1601	-
Optional				
No.	Equipment Name	Brand Name	Model Name	Remark
2	Jumper Cable*1	Tung-Li	1402-00WF000	Non-Shielded, 0.07m
3	Spacer box*1	PEGATRON	13BK-30Q0701	-



## 2.5 Support Equipment

For AC Conduction:

Support Equipment				
No.	Equipment	Brand Name	Model Name	FCC ID
A	PoE	PHIHONG	POE29U-1AT(PL)	N/A
B	Flash disk3.0	Transcend	JetFlash-700	N/A

For Radiated (below 1GHz):

Support Equipment				
No.	Equipment	Brand Name	Model Name	FCC ID
A	PoE	PHIHONG	POE29U-1AT(PL)	N/A
B	Notebook	DELL	E4300	N/A
C	Fixture	TEXAS INSTRUMENTS	LAUNCHXL-CC26X2R1	N/A

For Radiated (above 1GHz) and RF Conducted:

Support Equipment				
No.	Equipment	Brand Name	Model Name	FCC ID
A	PoE	CERIO	POE-G30	N/A
B	Notebook	DELL	E4300	N/A
C	Fixture	TEXAS INSTRUMENTS	LAUNCHXL-CC26X2R1	N/A

## 2.6 Test Setup Diagram

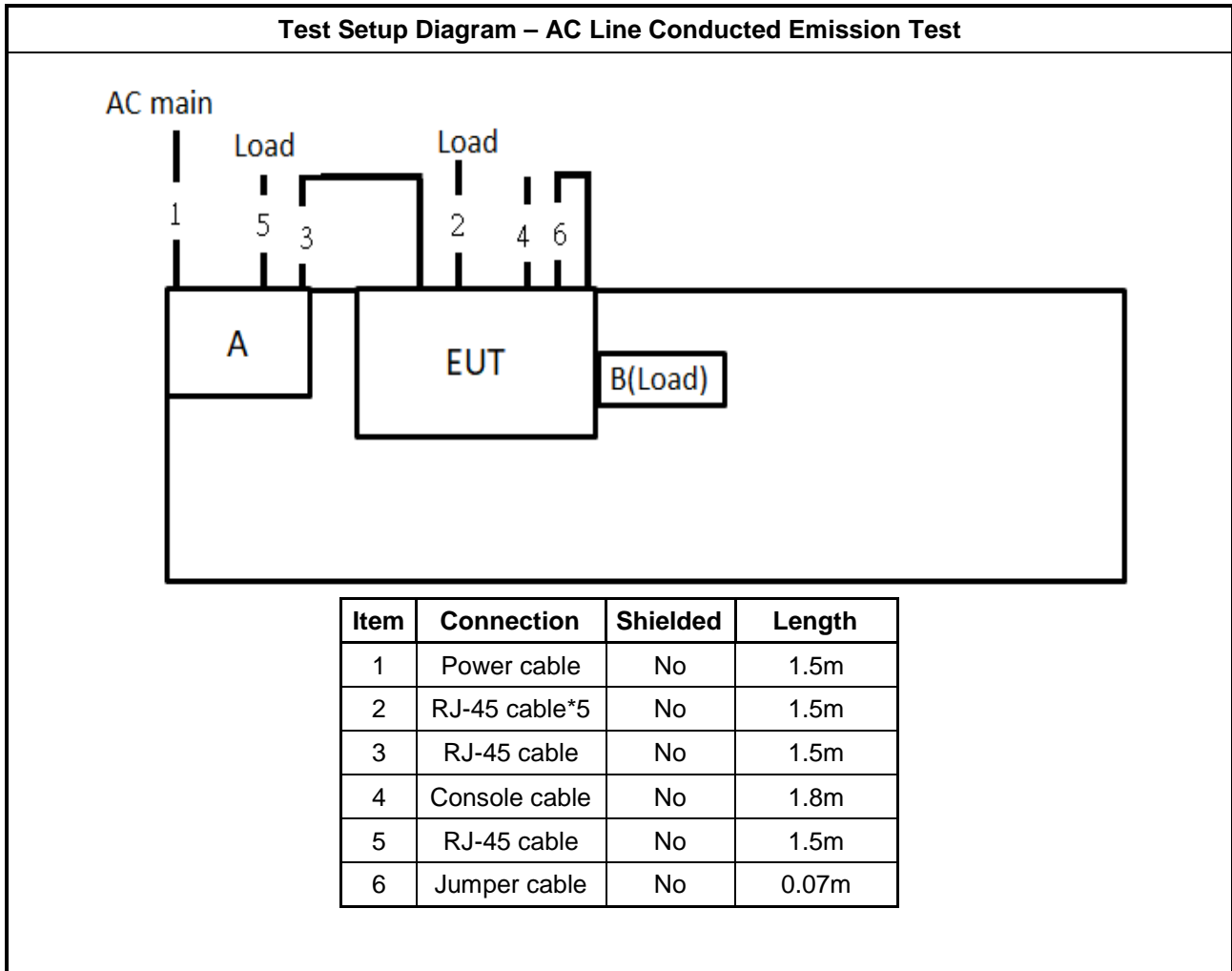



Test Setup Diagram - Radiated Test

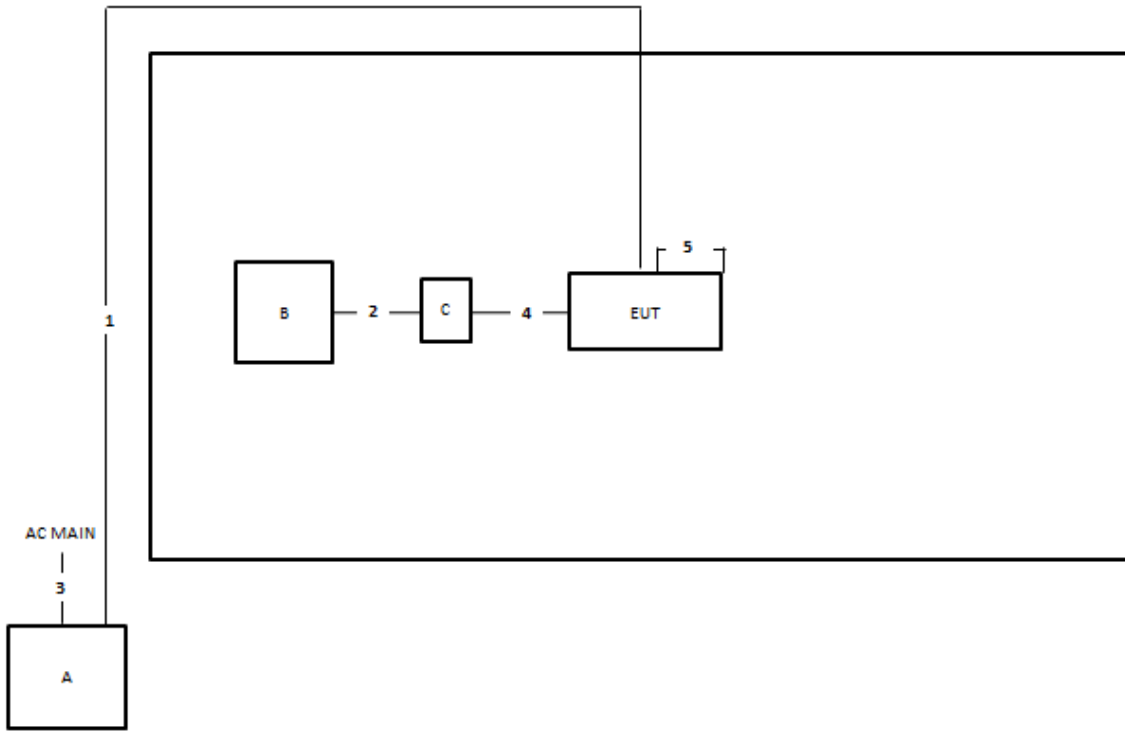

Item	Connection	Shielded	Length
1	RJ-45 cable	No	10m
2	USB cable	Yes	0.5m
3	Power cable	No	1.75m
4	Pin cable	No	0.1m
5	Jumper cable	No	0.07m



### 3 Transmitter Test Result

#### 3.1 AC Power-line Conducted Emissions

##### 3.1.1 AC Power-line Conducted Emissions Limit

AC Power-line Conducted Emissions Limit		
Frequency Emission (MHz)	Quasi-Peak	Average
0.15-0.5	66 - 56 *	56 - 46 *
0.5-5	56	46
5-30	60	50

Note 1: \* Decreases with the logarithm of the frequency.

##### 3.1.2 Measuring Instruments

Refer a test equipment and calibration data table in this test report.

##### 3.1.3 Test Procedures

Test Method
▪ Refer as ANSI C63.10-2013, clause 6.2 for AC power-line conducted emissions.



### 3.1.4 Test Setup

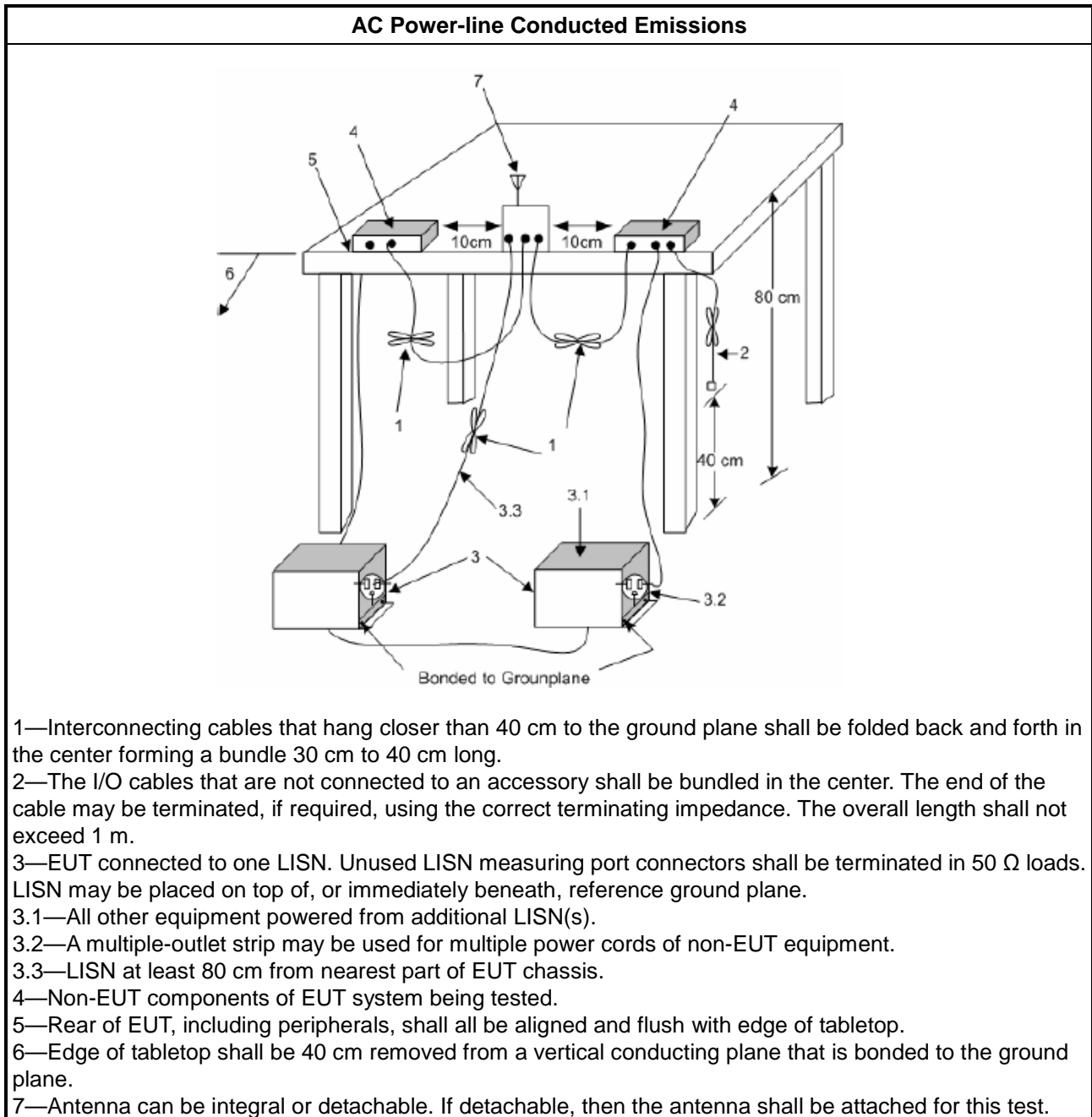

### 3.1.5 Test Result of AC Power-line Conducted Emissions

Refer as Appendix A

### 3.2 DTS Bandwidth

#### 3.2.1 6dB Bandwidth Limit

6dB Bandwidth Limit
<b>Systems using digital modulation techniques:</b>
<ul style="list-style-type: none"> <li>▪ 6 dB bandwidth <math>\geq</math> 500 kHz.</li> </ul>

#### 3.2.2 Measuring Instruments

Refer a test equipment and calibration data table in this test report.

#### 3.2.3 Test Procedures

Test Method
<ul style="list-style-type: none"> <li>▪ For the emission bandwidth shall be measured using one of the options below:</li> </ul>
<input checked="" type="checkbox"/> Refer as FCC KDB 558074, clause 8.2 & C63.10 clause 11.8.1 Option 1 for 6 dB bandwidth measurement.
<input type="checkbox"/> Refer as FCC KDB 558074, clause 8.2 & C63.10 clause 11.8.2 Option 2 for 6 dB bandwidth measurement.
<input type="checkbox"/> Refer as ANSI C63.10, clause 6.9.1 for occupied bandwidth testing.

#### 3.2.4 Test Setup

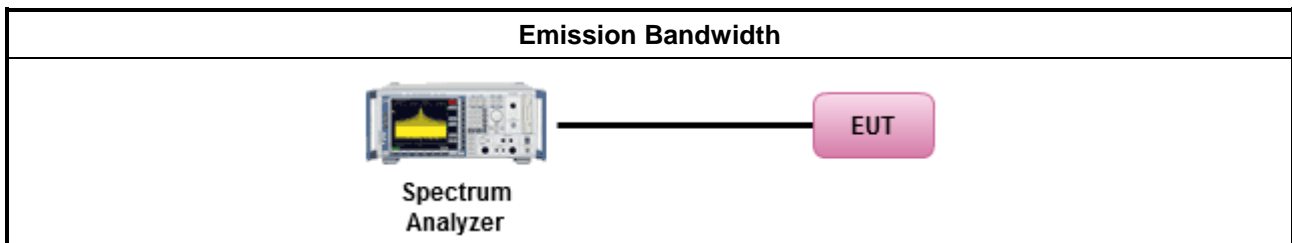

#### 3.2.5 Test Result of Emission Bandwidth

Refer as Appendix B



### 3.3 Maximum Conducted Output Power

#### 3.3.1 Maximum Conducted Output Power Limit

Maximum Conducted Output Power Limit	
	<ul style="list-style-type: none"> <li>▪ If <math>G_{TX} \leq 6</math> dBi, then <math>P_{Out} \leq 30</math> dBm (1 W)</li> </ul>
	<ul style="list-style-type: none"> <li>▪ Point-to-multipoint systems (P2M): If <math>G_{TX} &gt; 6</math> dBi, then <math>P_{Out} = 30 - (G_{TX} - 6)</math> dBm</li> </ul>
	<ul style="list-style-type: none"> <li>▪ Point-to-point systems (P2P): If <math>G_{TX} &gt; 6</math> dBi, then <math>P_{Out} = 30 - (G_{TX} - 6)/3</math> dBm</li> </ul>
	<ul style="list-style-type: none"> <li>▪ Smart antenna system (SAS):</li> </ul>
	<ul style="list-style-type: none"> <li>- Single beam: If <math>G_{TX} &gt; 6</math> dBi, then <math>P_{Out} = 30 - (G_{TX} - 6)/3</math> dBm</li> </ul>
	<ul style="list-style-type: none"> <li>- Overlap beam: If <math>G_{TX} &gt; 6</math> dBi, then <math>P_{Out} = 30 - (G_{TX} - 6)/3</math> dBm</li> </ul>
	<ul style="list-style-type: none"> <li>- Aggregate power on all beams: If <math>G_{TX} &gt; 6</math> dBi, then <math>P_{Out} = 30 - (G_{TX} - 6)/3 + 8</math> dB dBm</li> </ul>
<p><math>P_{Out}</math> = maximum peak conducted output power or maximum conducted output power in dBm,  <math>G_{TX}</math> = the maximum transmitting antenna directional gain in dBi.</p>	

#### 3.3.2 Measuring Instruments

Refer a test equipment and calibration data table in this test report.



3.3.3 Test Procedures

Test Method	
<ul style="list-style-type: none"> <li>▪ Maximum Peak Conducted Output Power</li> </ul>	
<input type="checkbox"/>	Refer as FCC KDB 558074, clause 8.3.1.1 & C63.10 clause 11.9.1.1 (RBW ≥ EBW method).
<input type="checkbox"/>	Refer as FCC KDB 558074, clause 8.3.1.3 & C63.10 clause 11.9.1.3 (peak power meter).
<ul style="list-style-type: none"> <li>▪ Maximum Conducted Output Power</li> </ul>	
[duty cycle ≥ 98% or external video / power trigger]	
<input type="checkbox"/>	Refer as FCC KDB 558074, clause 8.3.2.2 & C63.10 clause 11.9.2.2.2 Method AVGSA-1.
<input type="checkbox"/>	Refer as FCC KDB 558074, clause 8.3.2.2 & C63.10 clause 11.9.2.2.3 Method AVGSA-1A. (alternative)
duty cycle < 98% and average over on/off periods with duty factor	
<input type="checkbox"/>	Refer as FCC KDB 558074, clause 8.3.2.2 & C63.10 clause 11.9.2.2.4 Method AVGSA-2.
<input type="checkbox"/>	Refer as FCC KDB 558074, clause 8.3.2.2 & C63.10 clause 11.9.2.2.5 Method AVGSA-2A (alternative)
<input type="checkbox"/>	Refer as FCC KDB 558074, clause 8.3.2.2 & C63.10 clause 11.9.2.2.6 Method AVGSA-3
<input type="checkbox"/>	Refer as FCC KDB 558074, clause 8.3.2.2 & C63.10 clause 11.9.2.2.7 Method AVGSA-3A (alternative)
Measurement using a power meter (PM)	
<input type="checkbox"/>	Refer as FCC KDB 558074, clause 8.3.2.3 & C63.10 clause 11.9.2.3.1 Method AVGPM (using an RF average power meter).
<input checked="" type="checkbox"/>	Refer as FCC KDB 558074, clause 8.3.2.3 & C63.10 clause 11.9.2.3.2 Method AVGPM-G (using an gate RF average power meter).
<ul style="list-style-type: none"> <li>▪ For conducted measurement.</li> </ul>	
<ul style="list-style-type: none"> <li>▪ If the EUT supports multiple transmit chains using options given below: Refer as FCC KDB 662911, In-band power measurements. Using the measure-and-sum approach, measured all transmit ports individually. Sum the power (in linear power units e.g., mW) of all ports for each individual sample and save them.</li> </ul>	
<ul style="list-style-type: none"> <li>▪ If multiple transmit chains, EIRP calculation could be following as methods:  <math display="block">P_{total} = P_1 + P_2 + \dots + P_n</math>                     (calculated in linear unit [mW] and transfer to log unit [dBm])  <math display="block">EIRP_{total} = P_{total} + DG</math> </li> </ul>	

### 3.3.4 Test Setup

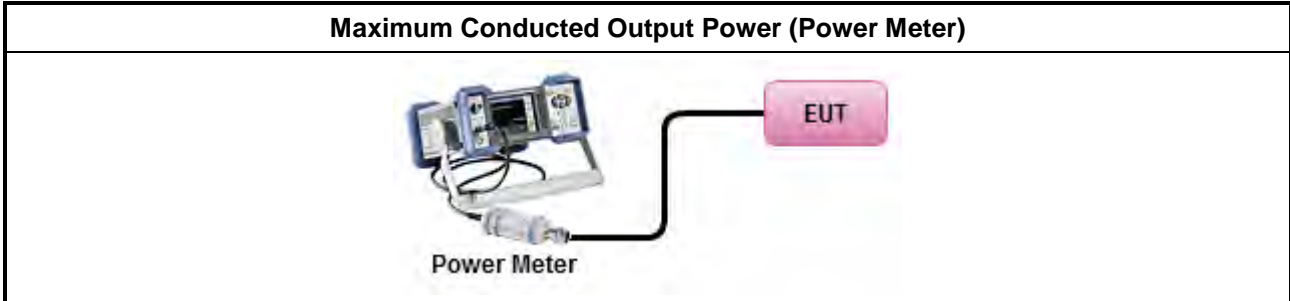

### 3.3.5 Test Result of Maximum Conducted Output Power

Refer as Appendix C



### 3.4 Power Spectral Density

#### 3.4.1 Power Spectral Density Limit

Power Spectral Density Limit
<ul style="list-style-type: none"> <li>Power Spectral Density (PSD) ≤ 8 dBm/3kHz</li> </ul>

#### 3.4.2 Measuring Instruments

Refer a test equipment and calibration data table in this test report.

#### 3.4.3 Test Procedures

Test Method
<ul style="list-style-type: none"> <li>Peak power spectral density procedures that the same method as used to determine the conducted output power. If maximum peak conducted output power was measured to demonstrate compliance to the output power limit, then the peak PSD procedure below (Method PKPSD) shall be used. If maximum conducted output power was measured to demonstrate compliance to the output power limit, then one of the average PSD procedures shall be used, as applicable based on the following criteria (the peak PSD procedure is also an acceptable option).</li> </ul>
<input checked="" type="checkbox"/> Refer as FCC KDB 558074, clause 8.4 & C63.10 clause 11.10 Method Max. PSD. [duty cycle ≥ 98% or external video / power trigger]
<ul style="list-style-type: none"> <li>For conducted measurement.</li> </ul>
<ul style="list-style-type: none"> <li>If The EUT supports multiple transmit chains using options given below:               <ul style="list-style-type: none"> <li><input type="checkbox"/> Option 1: Measure and sum the spectra across the outputs. Refer as FCC KDB 662911, In-band power spectral density (PSD). Sample all transmit ports simultaneously using a spectrum analyzer for each transmit port. Where the trace bin-by-bin of each transmit port summing can be performed. (i.e., in the first spectral bin of output 1 is summed with that in the first spectral bin of output 2 and that from the first spectral bin of output 3, and so on up to the NTX output to obtain the value for the first frequency bin of the summed spectrum.). Add up the amplitude (power) values for the different transmit chains and use this as the new data trace.</li> <li><input type="checkbox"/> Option 2: Measure and sum spectral maxima across the outputs. With this technique, spectra are measured at each output of the device at the required resolution bandwidth. The maximum value (peak) of each spectrum is determined. These maximum values are then summed mathematically in linear power units across the outputs. These operations shall be performed separately over frequency spans that have different out-of-band or spurious emission limits,</li> <li><input type="checkbox"/> Option 3: Measure and add 10 log(N) dB, where N is the number of transmit chains. Refer as FCC KDB 662911, In-band power spectral density (PSD). Performed at each transmit chains and each transmit chains shall be compared with the limit have been reduced with 10 log(N). Or each transmit chains shall be add 10 log(N) to compared with the limit.</li> </ul> </li> </ul>

### 3.4.4 Test Setup

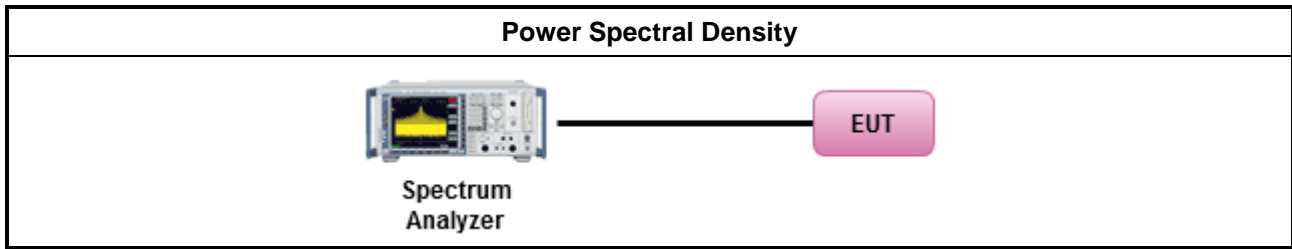

### 3.4.5 Test Result of Power Spectral Density

Refer as Appendix D

### 3.5 Emissions in Non-restricted Frequency Bands

#### 3.5.1 Emissions in Non-restricted Frequency Bands Limit

Un-restricted Band Emissions Limit	
RF output power procedure	Limit (dBc)
Peak output power procedure	20
Average output power procedure	30

Note 1: If the peak output power procedure is used to measure the fundamental emission power to demonstrate compliance to requirements, then the peak conducted output power measured within any 100 kHz outside the authorized frequency band shall be attenuated by at least 20 dB relative to the maximum measured in-band peak PSD level.

Note 2: If the average output power procedure is used to measure the fundamental emission power to demonstrate compliance to requirements, then the power in any 100 kHz outside of the authorized frequency band shall be attenuated by at least 30 dB relative to the maximum measured in-band average PSD level.

#### 3.5.2 Measuring Instruments

Refer a test equipment and calibration data table in this test report.

#### 3.5.3 Test Procedures

Test Method
<ul style="list-style-type: none"> <li>Refer as FCC KDB 558074, clause 8.5 for unwanted emissions into non-restricted bands.</li> </ul>

#### 3.5.4 Test Setup

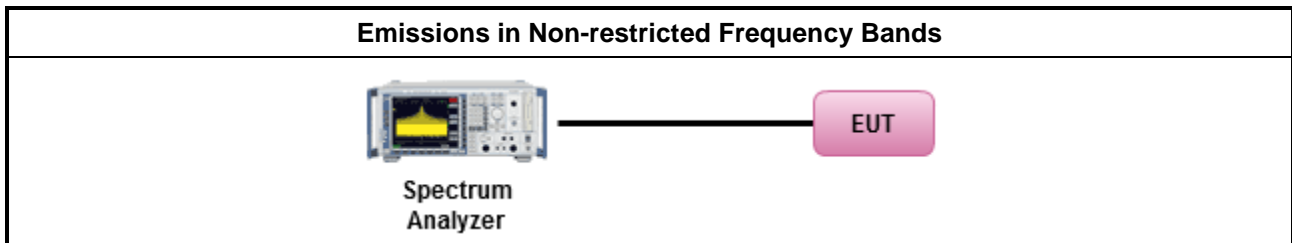

#### 3.5.5 Test Result of Emissions in Non-restricted Frequency Bands

Refer as Appendix E





### 3.6 Emissions in Restricted Frequency Bands

#### 3.6.1 Emissions in Restricted Frequency Bands Limit

Restricted Band Emissions Limit			
Frequency Range (MHz)	Field Strength (uV/m)	Field Strength (dBuV/m)	Measure Distance (m)
0.009~0.490	2400/F(kHz)	48.5 - 13.8	300
0.490~1.705	24000/F(kHz)	33.8 - 23	30
1.705~30.0	30	29	30
30~88	100	40	3
88~216	150	43.5	3
216~960	200	46	3
Above 960	500	54	3

Note 1: Test distance for frequencies at or above 30 MHz, measurements may be performed at a distance other than the limit distance provided they are not performed in the near field and the emissions to be measured can be detected by the measurement equipment. When performing measurements at a distance other than that specified, the results shall be extrapolated to the specified distance using an extrapolation factor of 20 dB/decade (inverse of linear distance for field-strength measurements, inverse of linear distance-squared for power-density measurements).

Note 2: Test distance for frequencies at below 30 MHz, measurements may be performed at a distance closer than the EUT limit distance; however, an attempt should be made to avoid making measurements in the near field. When performing measurements below 30 MHz at a closer distance than the limit distance, the results shall be extrapolated to the specified distance by either making measurements at a minimum of two or more distances on at least one radial to determine the proper extrapolation factor or by using the square of an inverse linear distance extrapolation factor (40 dB / decade). The test report shall specify the extrapolation method used to determine compliance of the EUT.

Note 3: Using the distance of 1m during the test for above 18 GHz, and the test value to correct for the distance factor at 3m.

#### 3.6.2 Measuring Instruments

Refer a test equipment and calibration data table in this test report.



**3.6.3 Test Procedures**

<b>Test Method</b>	
<ul style="list-style-type: none"> <li>▪ The average emission levels shall be measured in [duty cycle <math>\geq</math> 98 or duty factor].</li> </ul>	
<ul style="list-style-type: none"> <li>▪ Refer as ANSI C63.10, clause 6.10.3 band-edge testing shall be performed at the lowest frequency channel and highest frequency channel within the allowed operating band.</li> </ul>	
<ul style="list-style-type: none"> <li>▪ For the transmitter unwanted emissions shall be measured using following options below:</li> </ul>	
	<ul style="list-style-type: none"> <li>▪ Refer as FCC KDB 558074, clause 8.6 for unwanted emissions into restricted bands.</li> </ul>
	<input type="checkbox"/> Refer as FCC KDB 558074, clause 8.6 & C63.10 clause 11.12.2.5.1(trace averaging for duty cycle $\geq$ 98%).
	<input type="checkbox"/> Refer as FCC KDB 558074, clause 8.6 & C63.10 clause 11.12.2.5.2(trace averaging + duty factor).
	<input checked="" type="checkbox"/> Refer as FCC KDB 558074, clause 8.6 & C63.10 clause 11.12.2.5.3(Reduced VBW $\geq$ 1/T).
	<input type="checkbox"/> Refer as ANSI C63.10, clause 11.12.2.5.3 (Reduced VBW). VBW $\geq$ 1/T, where T is pulse time.
	<input type="checkbox"/> Refer as ANSI C63.10, clause 7.5 average value of pulsed emissions.
	<input checked="" type="checkbox"/> Refer as FCC KDB 558074, clause 8.6 & C63.10 clause 11.12.2.4 measurement procedure peak limit.
<ul style="list-style-type: none"> <li>▪ For the transmitter band-edge emissions shall be measured using following options below:</li> </ul>	
	<ul style="list-style-type: none"> <li>▪ Refer as FCC KDB 558074 clause 8.7 &amp; c63.10 clause 11.13.1, When the performing peak or average radiated measurements, emissions within 2 MHz of the authorized band edge may be measured using the marker-delta method described below.</li> </ul>
	<ul style="list-style-type: none"> <li>▪ Refer as FCC KDB 558074, clause 8.7 (ANSI C63.10, clause 6.10.6) for marker-delta method for band-edge measurements.</li> </ul>
	<ul style="list-style-type: none"> <li>▪ Refer as FCC KDB 558074, clause 8.7 for narrower resolution bandwidth (100kHz) using the band power and summing the spectral levels (i.e., 1 MHz).</li> </ul>
	<ul style="list-style-type: none"> <li>▪ For conducted unwanted emissions into restricted bands (absolute emission limits). Devices with multiple transmit chains using options given below:                (1) Measure and sum the spectra across the outputs or                (2) Measure and add 10 log(N) dB             </li> </ul>
	<ul style="list-style-type: none"> <li>▪ For FCC KDB 662911 The methodology described here may overestimate array gain, thereby resulting in apparent failures to satisfy the out-of-band limits even if the device is actually compliant. In such cases, compliance may be demonstrated by performing radiated tests around the frequencies at which the apparent failures occurred.</li> </ul>



<b>Test Method</b>	
▪	For conducted and cabinet radiation measurement, refer as FCC KDB 558074, clause 8.6 & C63.10 clause 11.12.2.2.
▪	For conducted unwanted emissions into non-restricted bands (relative emission limits). Devices with multiple transmit chains: Refer as FCC KDB 662911, when testing out-of-band and spurious emissions against relative emission limits, tests may be performed on each output individually without summing or adding 10 log(N) if the measurements are made relative to the in-band emissions on the individual outputs.
▪	For conducted unwanted emissions into restricted bands (absolute emission limits). Devices with multiple transmit chains using options given below: (1) Measure and sum the spectra across the outputs or (2) Measure and add 10 log(N) dB
▪	For FCC KDB 662911 The methodology described here may overestimate array gain, thereby resulting in apparent failures to satisfy the out-of-band limits even if the device is actually compliant. In such cases, compliance may be demonstrated by performing radiated tests around the frequencies at which the apparent failures occurred.

3.6.4 Test Setup

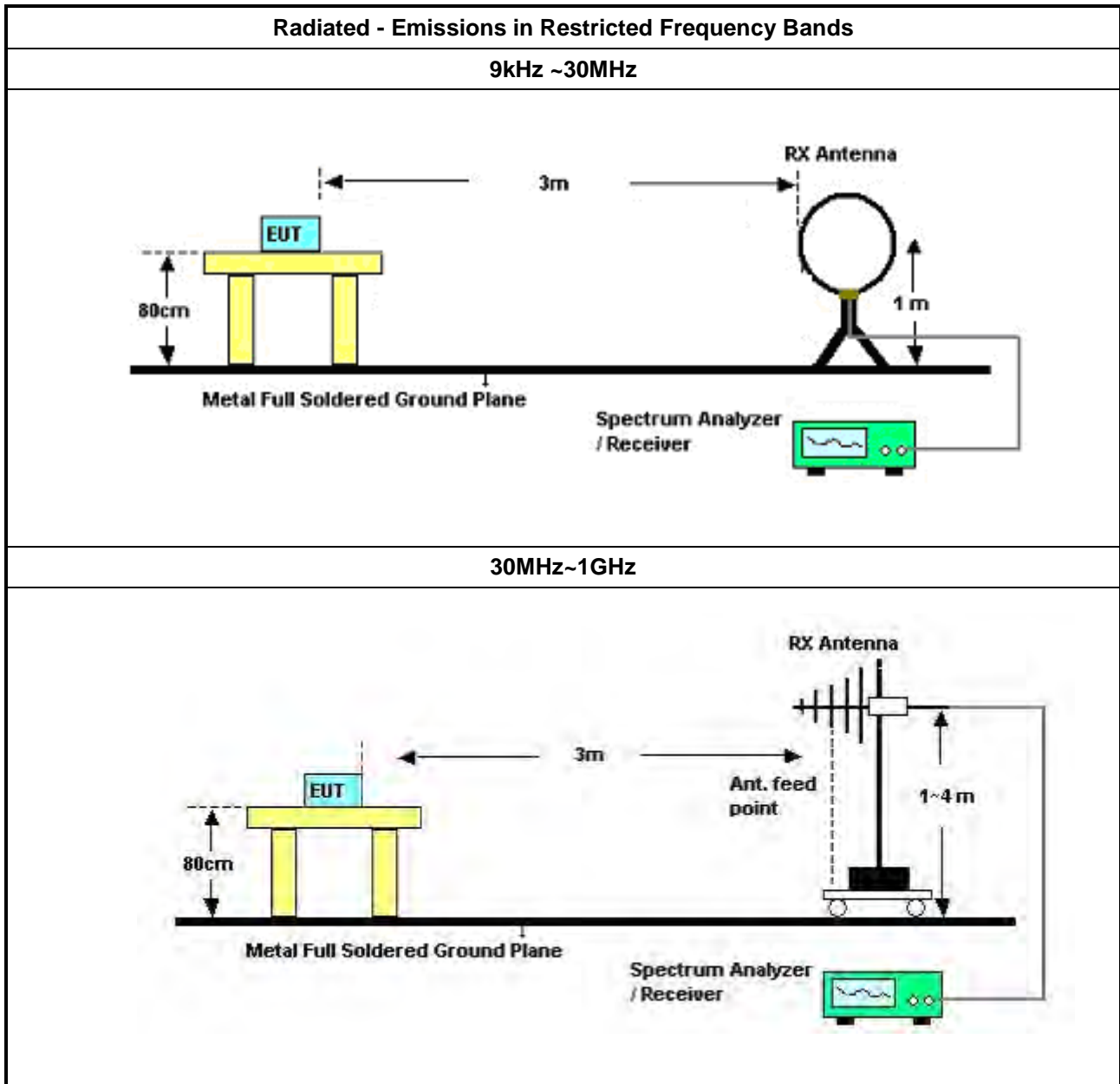

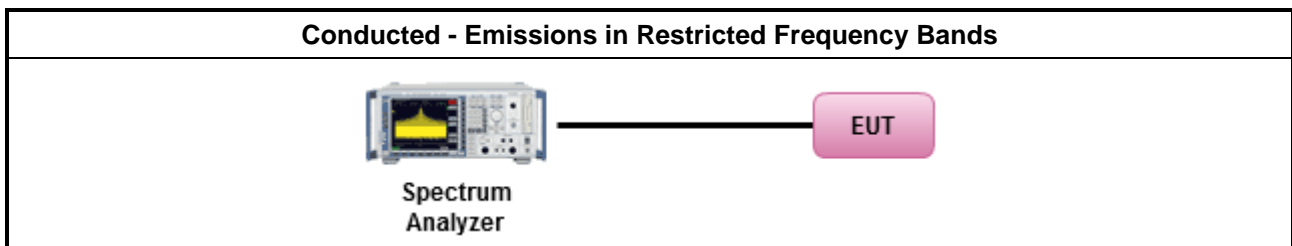
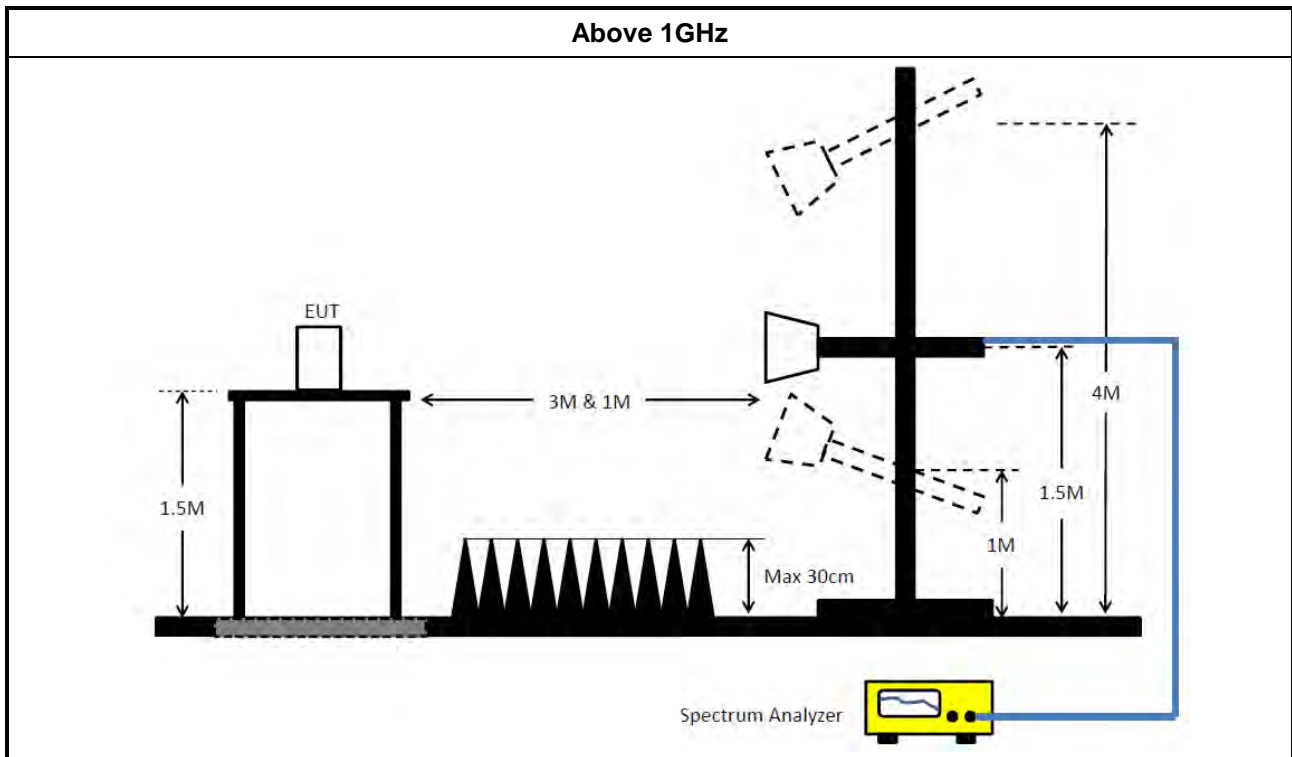

**3.6.5 Measurement Results Calculation**

The measured Level is calculated using:  
 Corrected Reading: Antenna Factor + Cable Loss + Read Level - Preamp Factor = Level.

**3.6.6 Emissions in Restricted Frequency Bands (Below 30MHz)**

There is a comparison data of both open-field test site and alternative test site - semi-Anechoic chamber according to KDB414788 Radiated Test Site, and the result came out very similar.

All amplitude of spurious emissions that are attenuated by more than 20 dB below the permissible value has no need to be reported.

The radiated emissions were investigated from 9 kHz or the lowest frequency generated within the device, up to the 10 harmonic or 40 GHz, whichever is appropriate.

**3.6.7 Test Result of Emissions in Restricted Frequency Bands**

Refer as Appendix F



## 4 Test Equipment and Calibration Data

Instrument	Manufacturer	Model No.	Serial No.	Characteristics	Calibration Date	Calibration Due Date	Remark
EMI Receiver	Agilent	N9038A	My52260123	9kHz ~ 8.45GHz	Feb. 26, 2020	Feb. 25, 2021	Conduction (CO01-CB)
LISN	F.C.C.	FCC-LISN-50-16-2	04083	150kHz ~ 100MHz	Dec. 25, 2019	Dec. 24, 2020	Conduction (CO01-CB)
LISN	Schwarzbeck	NSLK 8127	8127647	9kHz ~ 30MHz	Feb. 25, 2020	Feb. 24, 2021	Conduction (CO01-CB)
COND Cable	Woken	Cable	Low cable-CO01	9kHz ~ 30MHz	May 21, 2019	May 20, 2020	Conduction (CO01-CB)
Software	Audix	E3	6.120210n	-	N.C.R.	N.C.R.	Conduction (CO01-CB)
Loop Antenna	Teseq	HLA 6120	24155	9kHz - 30 MHz	Mar. 29, 2019	Mar. 28, 2020	Radiation (03CH05-CB)
Loop Antenna	Teseq	HLA 6120	24155	9kHz - 30 MHz	Apr. 13, 2020	Apr. 12, 2021	Radiation (03CH05-CB)
Bilog Antenna with 6dB Attenuator	TESEQ & EMCI	CBL 6112D & N-6-06	35236 & AT-N0610	30MHz ~ 2GHz	Mar. 28, 2019	Mar. 27, 2020	Radiation (03CH05-CB)
Bilog Antenna with 6dB Attenuator	TESEQ & EMCI	CBL 6112D & N-6-06	35236 & AT-N0610	30MHz ~ 2GHz	Mar. 27, 2020	Mar. 26, 2021	Radiation (03CH05-CB)
Horn Antenna	SCHWARZBECK	BBHA9120D	BBHA 9120D-1291	1GHz~18GHz	Oct. 05, 2019	Oct. 04, 2020	Radiation (03CH05-CB)
Horn Antenna	SCHWARZBECK	BBHA 9170	BBHA9170507	15GHz ~ 40GHz	Jun. 12, 2019	Jun. 11, 2020	Radiation (03CH05-CB)
Pre-Amplifier	Agilent	310N	187291	0.1MHz ~ 1GHz	Mar. 20, 2019	Mar. 19, 2020	Radiation (03CH05-CB)
Pre-Amplifier	Agilent	310N	187291	0.1MHz ~ 1GHz	Mar. 19, 2020	Mar. 18, 2021	Radiation (03CH05-CB)
Pre-Amplifier	Agilent	83017A	MY53270063	0.5GHz ~ 26.5GHz	Mar. 19, 2019	Mar. 18, 2020	Radiation (03CH05-CB)
Pre-Amplifier	Agilent	83017A	MY53270063	0.5GHz ~ 26.5GHz	Mar. 11, 2020	Mar. 10, 2021	Radiation (03CH05-CB)
Pre-Amplifier	MITEQ	TTA1840-35-HG	1864479	18GHz ~ 40GHz	Jul. 03, 2019	Jul. 02, 2020	Radiation (03CH05-CB)
Spectrum Analyzer	R&S	FSP40	100304	9kHz ~ 40GHz	Aug. 15, 2019	Aug. 14, 2020	Radiation (03CH05-CB)
EMI Test Receiver	R&S	ESCS	826547/017	9kHz ~ 2.75GHz	May 15, 2019	May 14, 2020	Radiation (03CH05-CB)



Instrument	Manufacturer	Model No.	Serial No.	Characteristics	Calibration Date	Calibration Due Date	Remark
RF Cable-low	Woken	RG402	LOW Cable-04+23	30MHz~1GHz	Oct. 07, 2019	Oct. 06, 2020	Radiation (03CH05-CB)
RF Cable-high	Woken	RG402	High Cable-28	1GHz~18GHz	Oct. 07, 2019	Oct. 06, 2020	Radiation (03CH05-CB)
RF Cable-high	Woken	RG402	High Cable-04+28	1GHz~18GHz	Oct. 07, 2019	Oct. 06, 2020	Radiation (03CH05-CB)
RF Cable-high	Woken	RG402	High Cable-40G#1	18GHz ~ 40 GHz	Jul. 24, 2019	Jul. 23, 2020	Radiation (03CH05-CB)
RF Cable-high	Woken	RG402	High Cable-40G#2	18GHz ~ 40 GHz	Jul. 24, 2019	Jul. 23, 2020	Radiation (03CH05-CB)
Spectrum analyzer	R&S	FSV40	101027	9kHz~40GHz	Jul. 02, 2019	Jul. 01, 2020	Conducted (TH01-CB)
RF Cable-high	Woken	RG402	High Cable-06	1 GHz – 26.5 GHz	Oct. 07, 2019	Oct. 06, 2020	Conducted (TH01-CB)
RF Cable-high	Woken	RG402	High Cable-07	1 GHz –26.5 GHz	Oct. 07, 2019	Oct. 06, 2020	Conducted (TH01-CB)
RF Cable-high	Woken	RG402	High Cable-08	1 GHz –26.5 GHz	Oct. 07, 2019	Oct. 06, 2020	Conducted (TH01-CB)
RF Cable-high	Woken	RG402	High Cable-09	1 GHz –26.5 GHz	Oct. 07, 2019	Oct. 06, 2020	Conducted (TH01-CB)
RF Cable-high	Woken	RG402	High Cable-10	1 GHz –26.5 GHz	Oct. 07, 2019	Oct. 06, 2020	Conducted (TH01-CB)
RF Cable-high	Woken	RG402	High Cable-28	1 GHz –26.5 GHz	Nov. 18, 2019	Nov. 17, 2020	Conducted (TH01-CB)
Power Sensor	Agilent	E9327A	US40442088	50MHz~18GHz	Feb. 07, 2020	Feb. 06, 2021	Conducted (TH01-CB)
Power Meter	Agilent	E4416A	GB41291199	50MHz~18GHz	Feb. 07, 2020	Feb. 06, 2021	Conducted (TH01-CB)

Note: Calibration Interval of instruments listed above is one year.

NCR means Non-Calibration required.



# AC Power-line Conducted Emissions Result

Appendix A

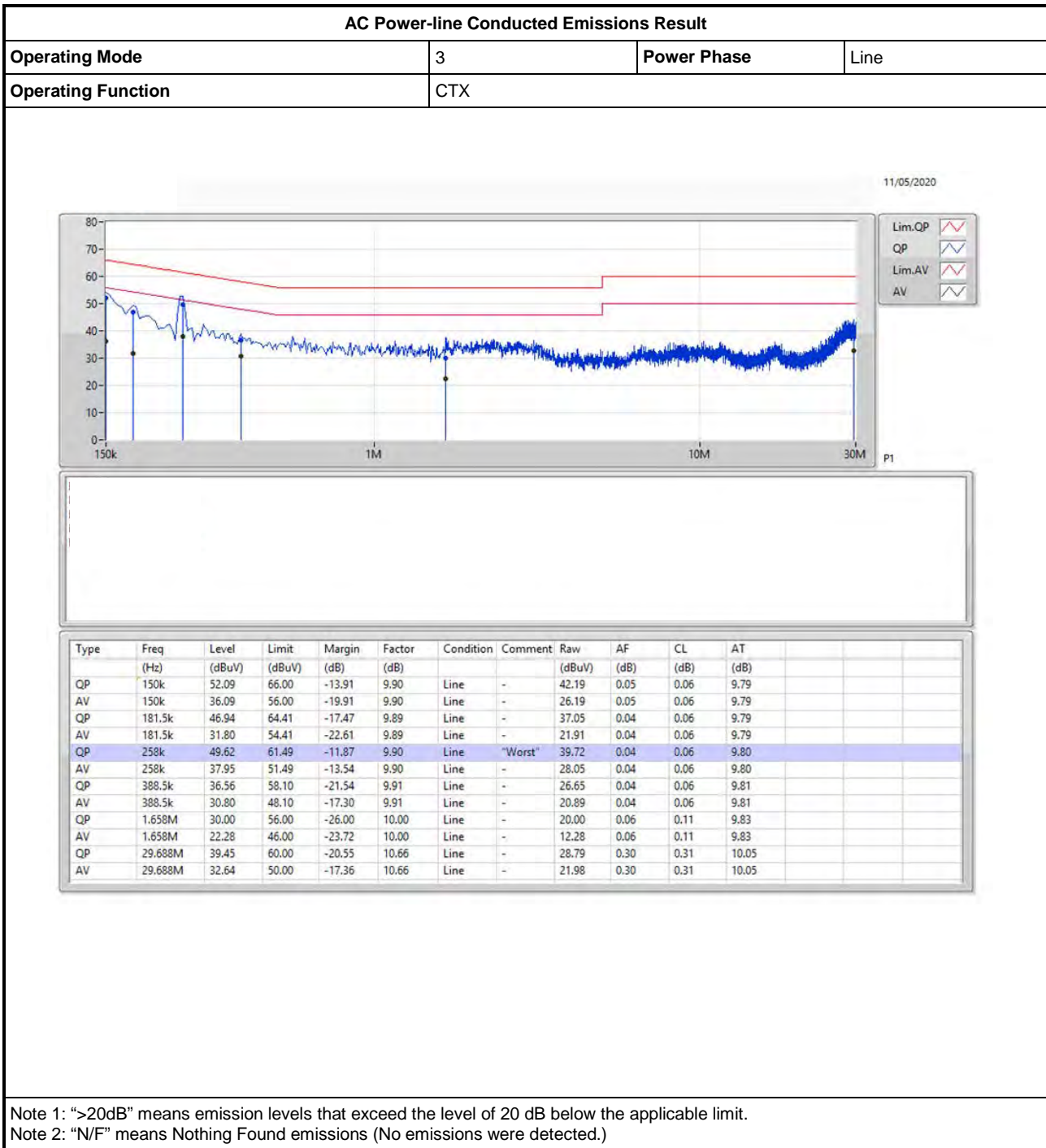





# AC Power-line Conducted Emissions Result

Appendix A

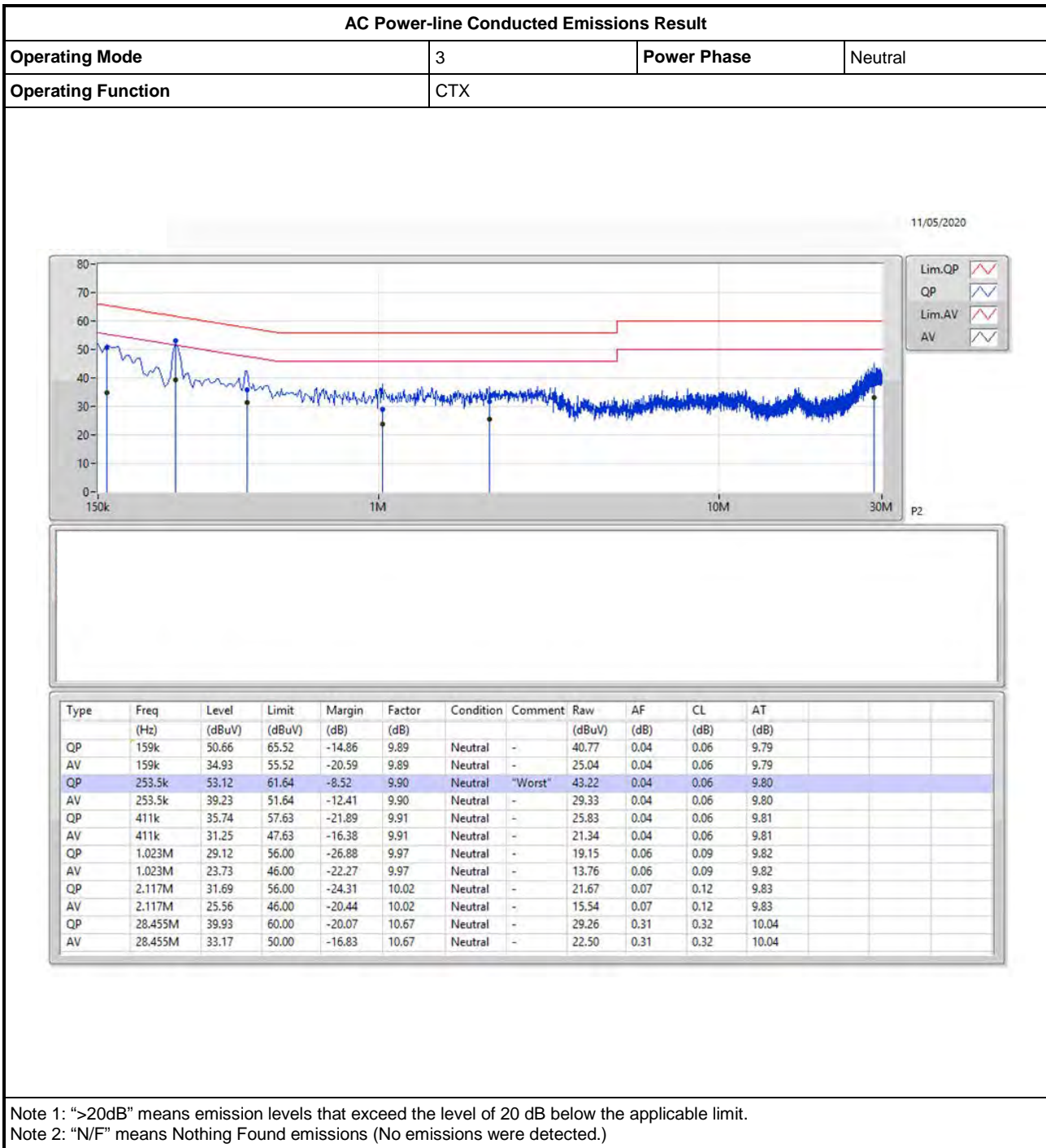



Summary

Mode	Max-N dB (Hz)	Max-OBW (Hz)	ITU-Code	Min-N dB (Hz)	Min-OBW (Hz)
2.4-2.4835GHz	-	-	-	-	-
BT-LE(1Mbps)	705k	1.078M	1M08F1D	683.75k	1.051M
BT-LE(2Mbps)	1.44M	2.075M	2M08F1D	1.374M	2.046M

**Max-N dB** = Maximum 6dB down bandwidth; **Max-OBW** = Maximum 99% occupied bandwidth;  
**Min-N dB** = Minimum 6dB down bandwidth; **Min-OBW** = Minimum 99% occupied bandwidth;



Result

Mode	Result	Limit (Hz)	Port 1-N dB (Hz)	Port 1-OBW (Hz)
BT-LE(1Mbps)	-	-	-	-
2402MHz	Pass	500k	705k	1.078M
2440MHz	Pass	500k	683.75k	1.051M
2480MHz	Pass	500k	695k	1.061M
BT-LE(2Mbps)	-	-	-	-
2402MHz	Pass	500k	1.44M	2.075M
2440MHz	Pass	500k	1.413M	2.046M
2480MHz	Pass	500k	1.374M	2.066M

Port X-N dB = Port X 6dB down bandwidth; Port X-OBW = Port X 99% occupied bandwidth;

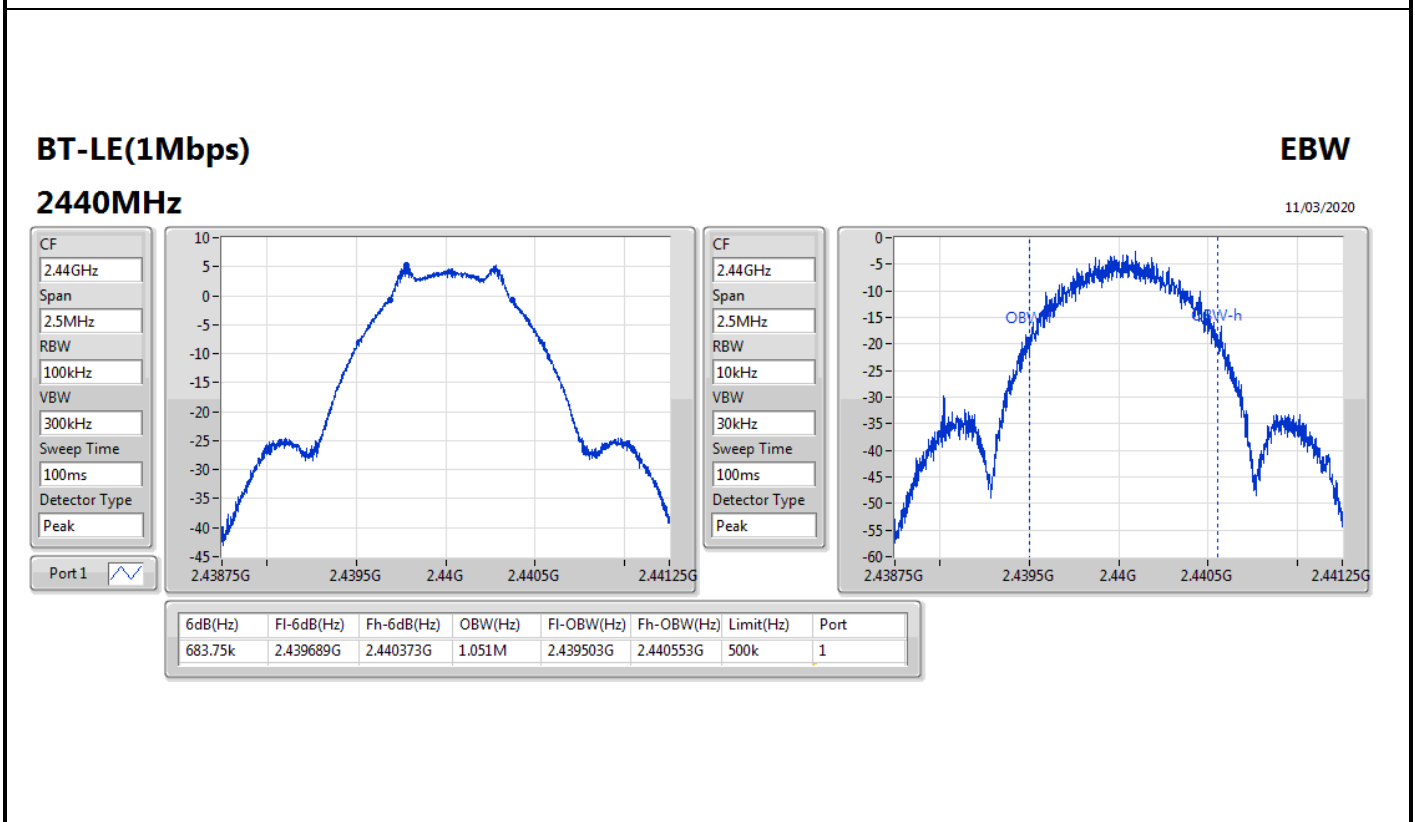
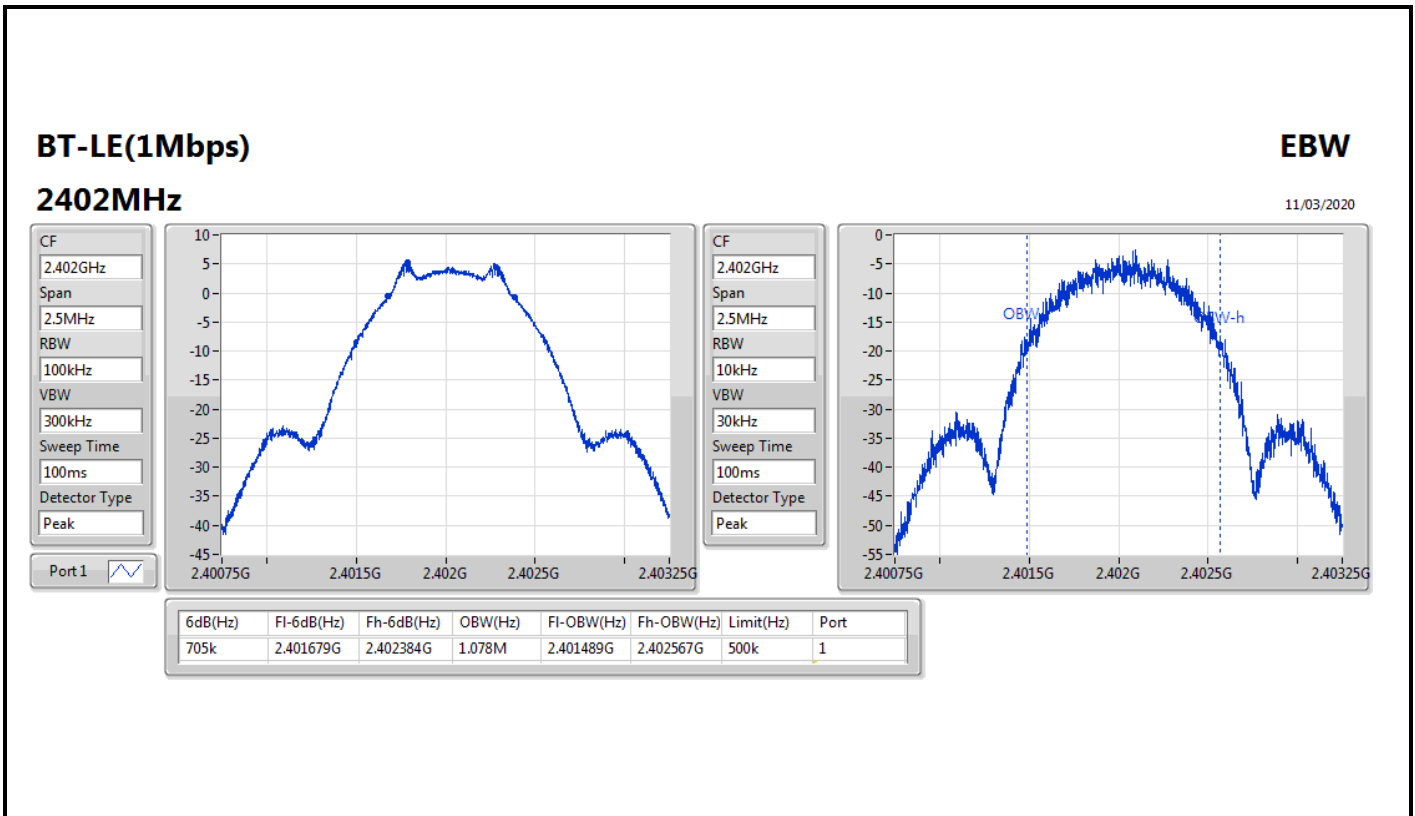

**BT-LE(1Mbps)**

**EBW**

**2480MHz**

11/03/2020

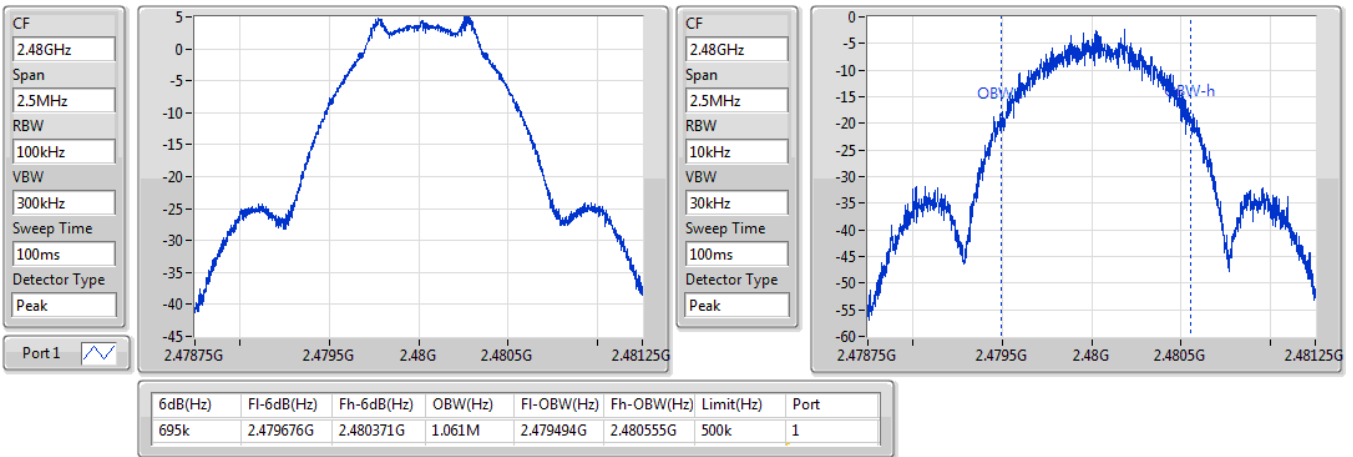

**BT-LE(2Mbps)**

**EBW**

**2402MHz**

11/03/2020

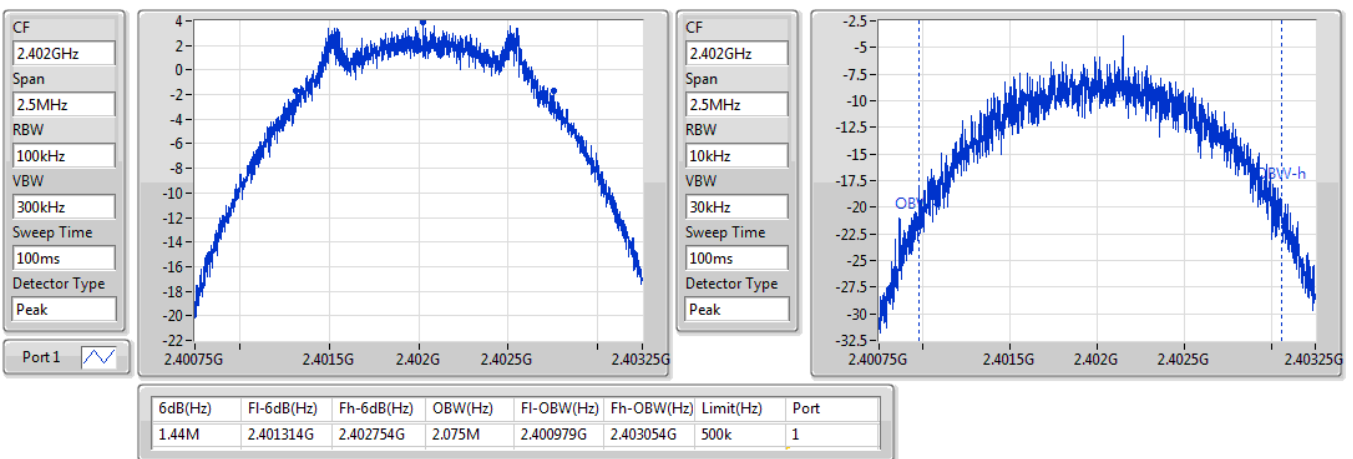

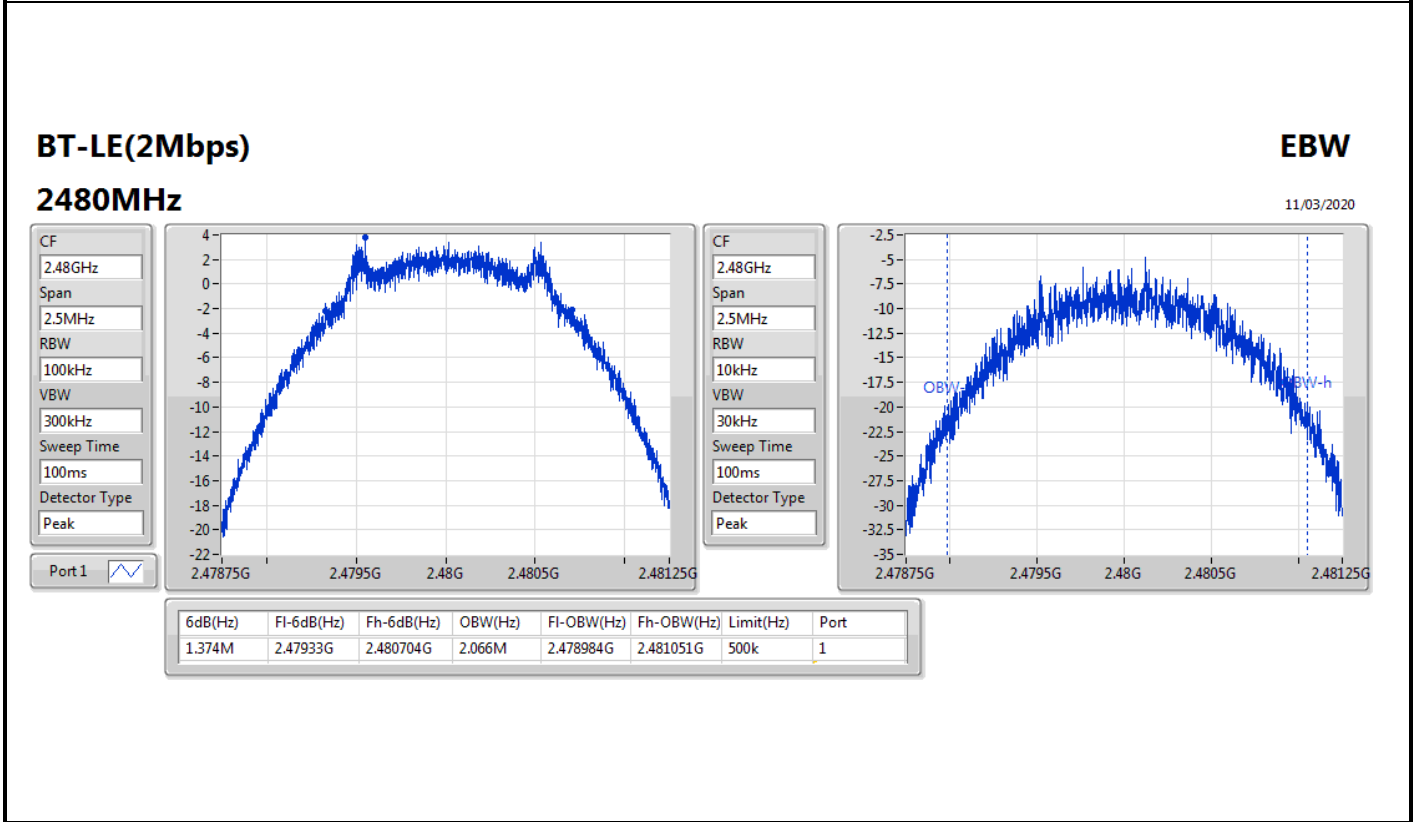
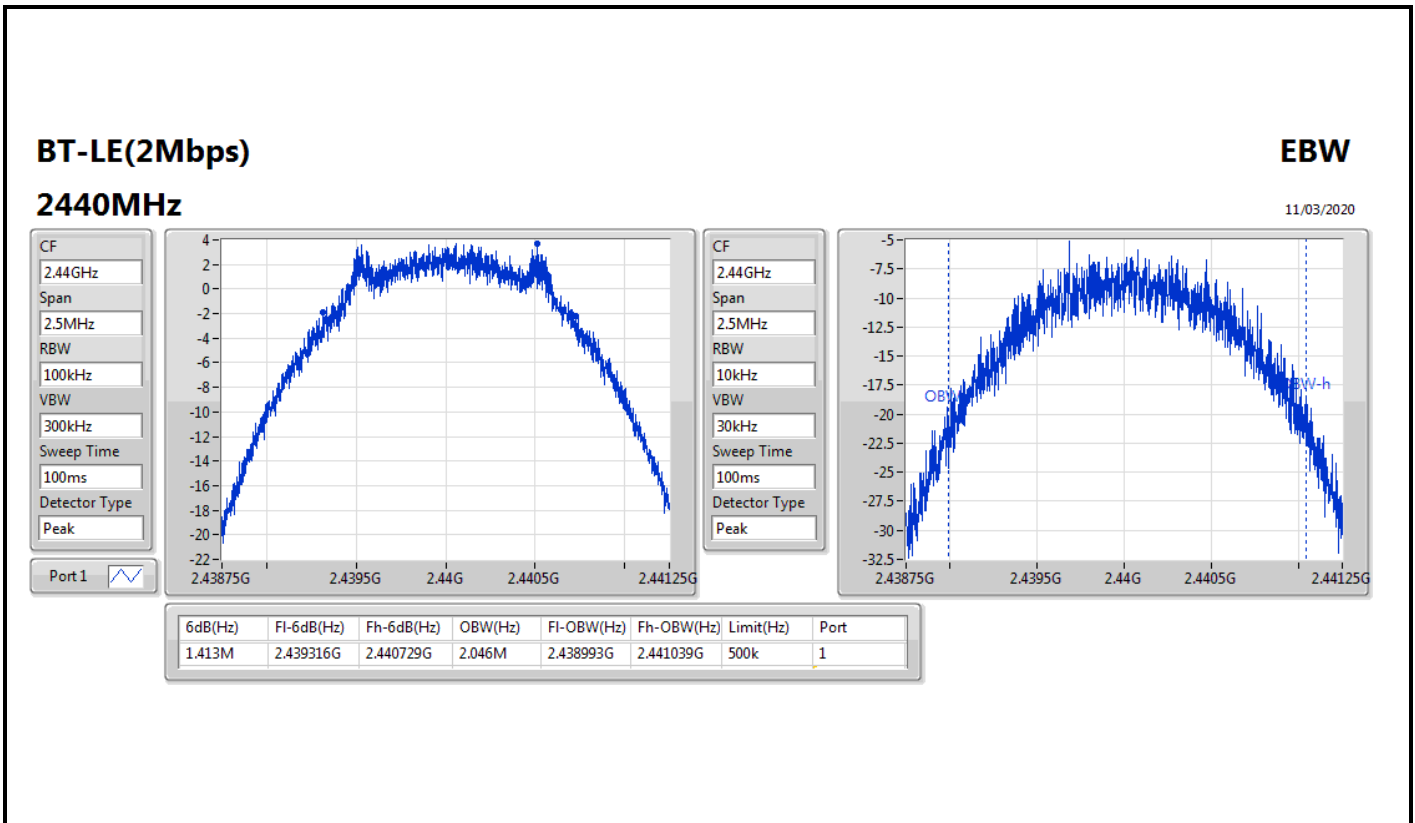



**Summary**

Mode	Power (dBm)	Power (W)	EIRP (dBm)	EIRP (W)
2.4-2.4835GHz	-	-		
BT-LE(1Mbps)	5.24	0.00334	7.84	0.00609
BT-LE(2Mbps)	5.22	0.00333	7.86	0.00611



**Result**

Mode	Result	Gain (dBi)	Power (dBm)	Power Limit (dBm)	EIRP Power (dBm)
BT-LE(1Mbps)	-	-	-	-	-
2402MHz	Pass	2.47	5.24	30.00	7.71
2440MHz	Pass	2.70	5.14	30.00	7.84
2480MHz	Pass	2.58	4.90	30.00	7.48
BT-LE(2Mbps)	-	-	-	-	-
2402MHz	Pass	2.47	5.22	30.00	7.69
2440MHz	Pass	2.70	5.16	30.00	7.86
2480MHz	Pass	2.58	4.92	30.00	7.50

**DG** = Directional Gain; **Port X** = Port X output power





**Summary**

Mode	PD (dBm/RBW)
2.4-2.4835GHz	-
BT-LE(1Mbps)	-5.45
BT-LE(2Mbps)	-10.41

RBW=3 kHz.



Result

Mode	Result	Gain (dBi)	PD (dBm/RBW)	PD Limit (dBm/RBW)
BT-LE(1Mbps)	-	-	-	-
2402MHz	Pass	2.47	-5.45	8.00
2440MHz	Pass	2.70	-7.95	8.00
2480MHz	Pass	2.58	-9.67	8.00
BT-LE(2Mbps)	-	-	-	-
2402MHz	Pass	2.47	-10.57	8.00
2440MHz	Pass	2.70	-11.40	8.00
2480MHz	Pass	2.58	-10.41	8.00

DG = Directional Gain; RBW=3 kHz;

PD = trace bin-by-bin of each transmits port summing can be performed maximum power density; Port X = Port X power density;

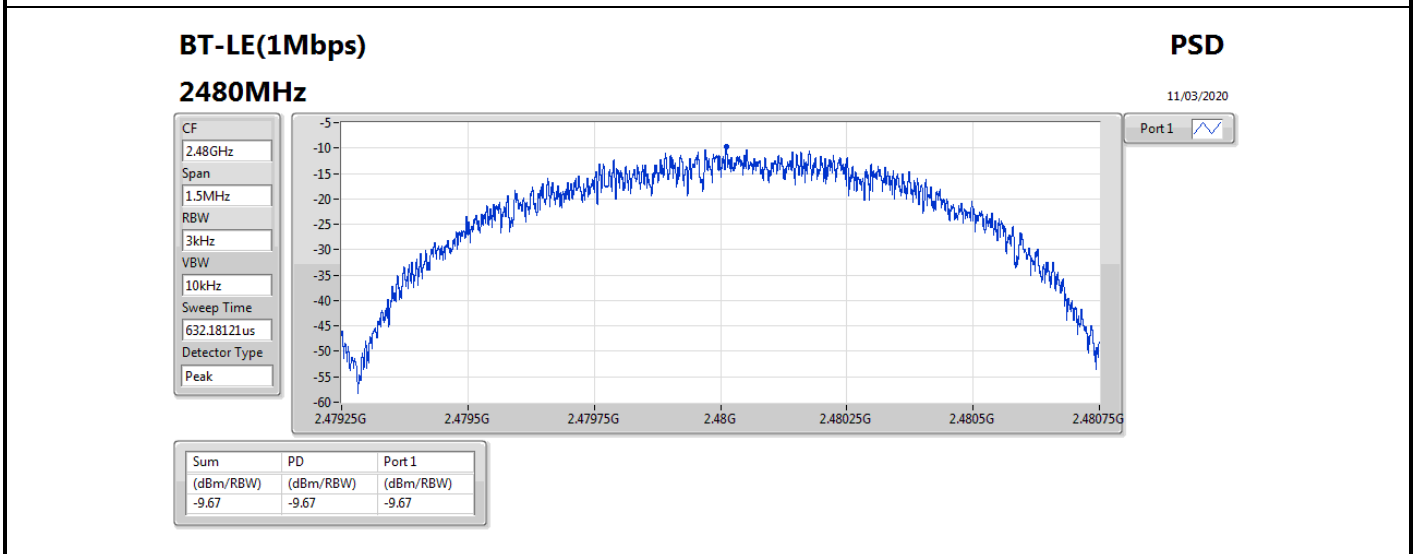
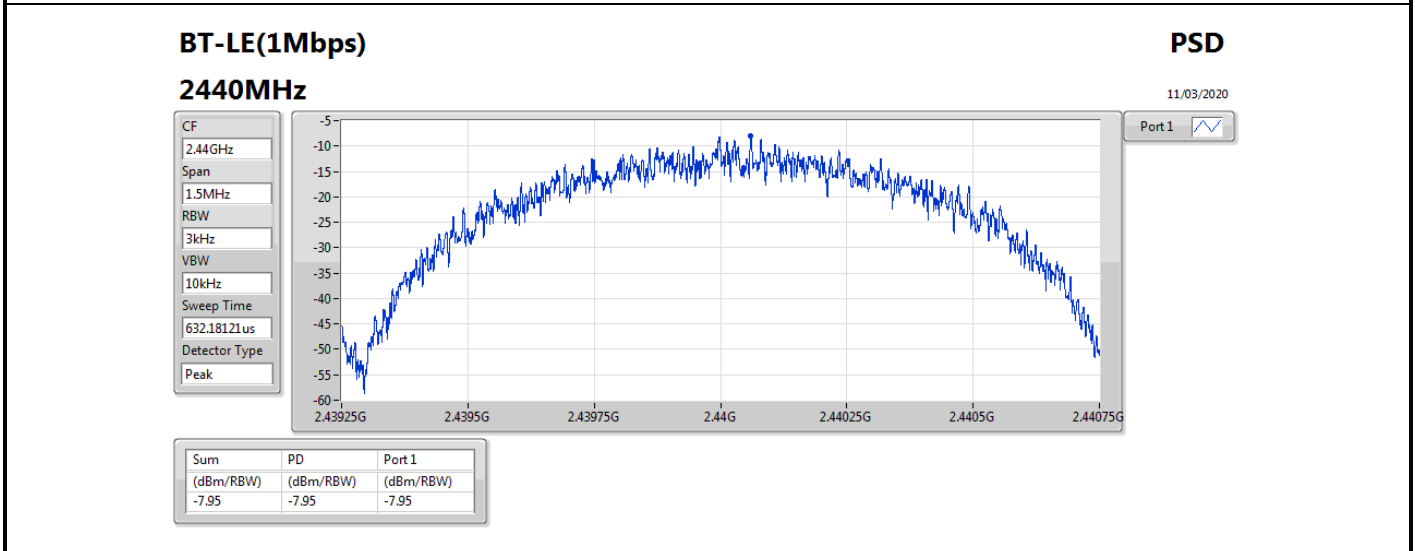
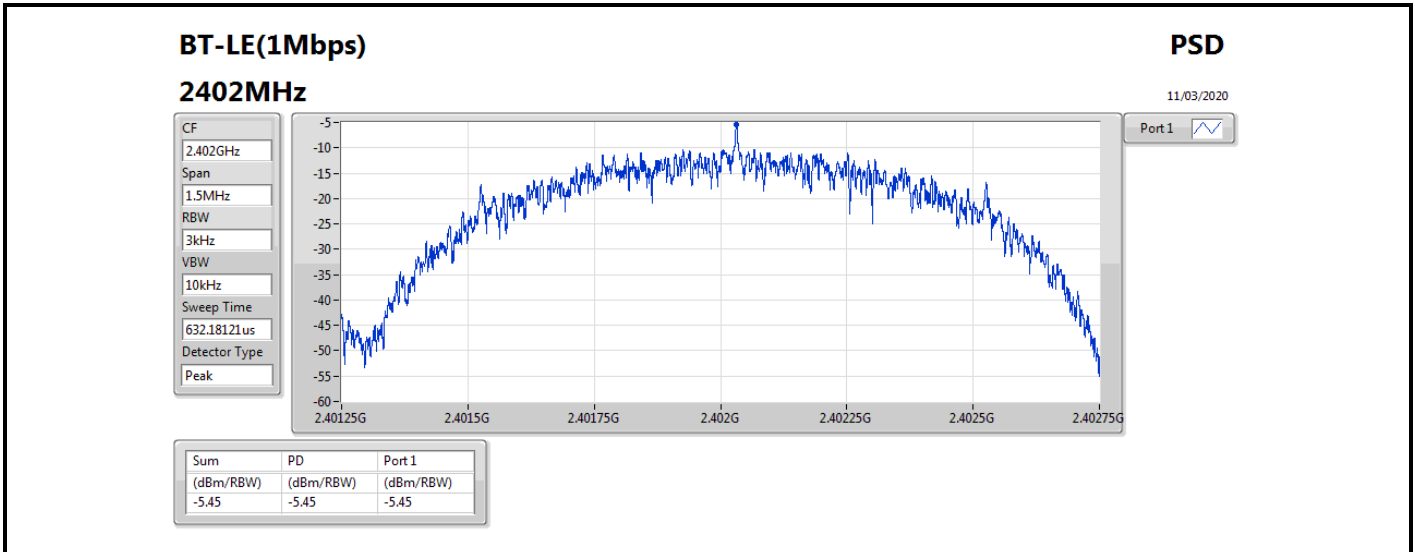

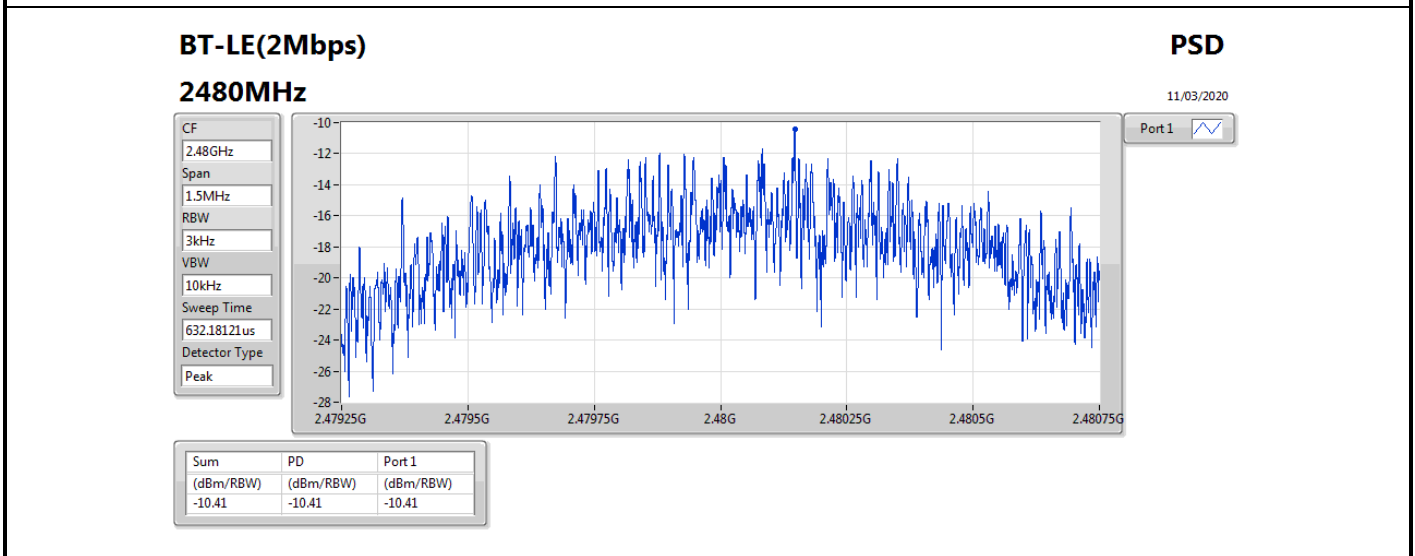
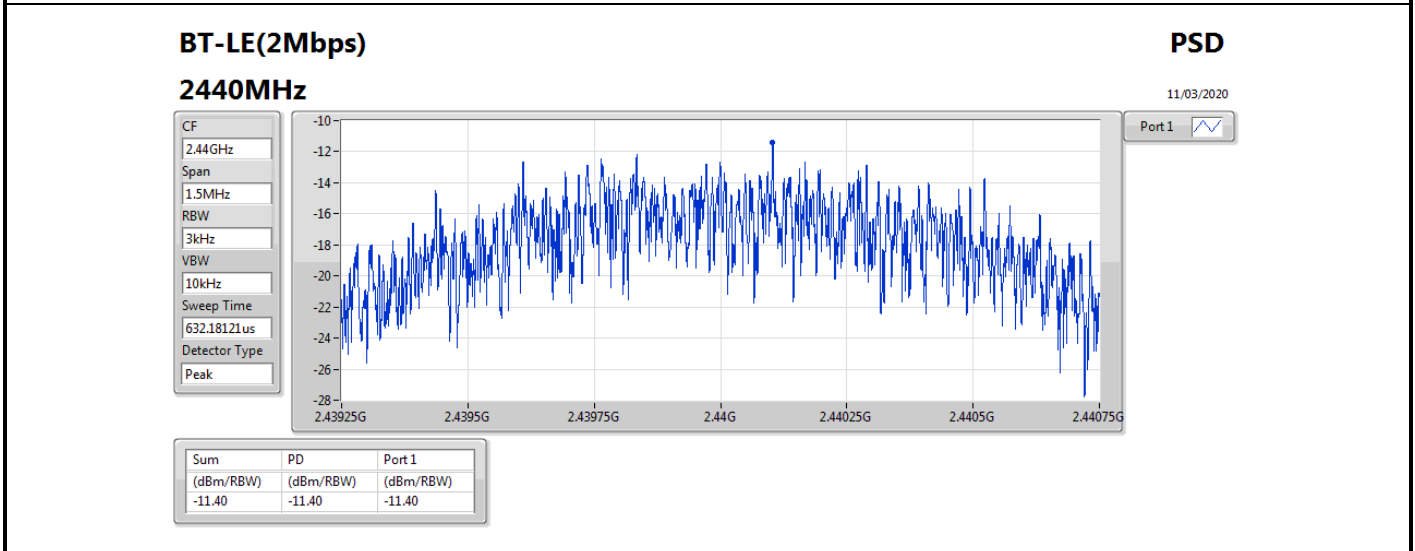
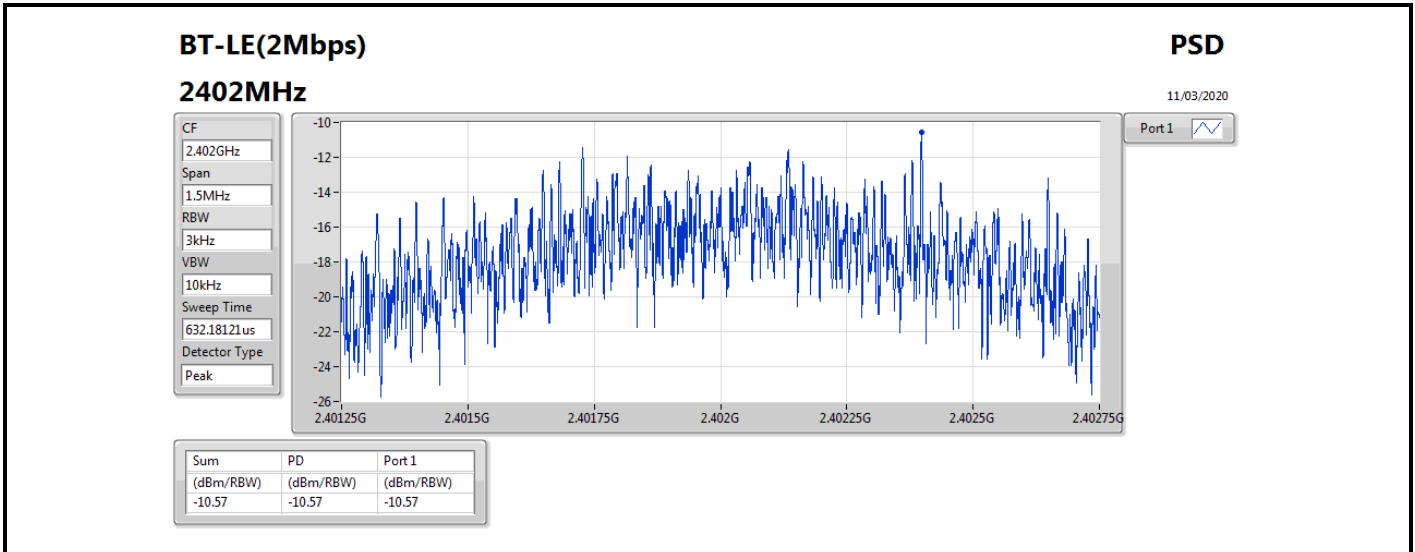



Summary

Mode	Result	Ref (Hz)	Ref (dBm)	Limit (dBm)	Freq (Hz)	Level (dBm)	Freq (Hz)	Level (dBm)	Freq (Hz)	Level (dBm)	Freq (Hz)	Level (dBm)	Freq (Hz)	Level (dBm)	Port
2.4-2.4835GHz	-	-	-	-	-	-	-	-	-	-	-	-	-	-	-
BT-LE(1Mbps)	Pass	2.40225G	5.26	-24.74	2.098G	-52.88	2.4G	-44.27	2.4G	-42.47	2.49005G	-50.93	16.44289G	-45.73	1
BT-LE(2Mbps)	Pass	2.40154G	4.19	-25.81	695.05M	-52.89	2.4G	-26.99	2.4G	-26.26	2.48542G	-52.18	16.45977G	-45.41	1



Result

Mode	Result	Ref (Hz)	Ref (dBm)	Limit (dBm)	Freq (Hz)	Level (dBm)	Freq (Hz)	Level (dBm)	Freq (Hz)	Level (dBm)	Freq (Hz)	Level (dBm)	Freq (Hz)	Level (dBm)	Port
BT-LE(1Mbps)	-	-	-	-	-	-	-	-	-	-	-	-	-	-	-
2402MHz	Pass	2.40225G	5.26	-24.74	2.098G	-52.88	2.4G	-44.27	2.4G	-42.47	2.49005G	-50.93	16.44289G	-45.73	1
2440MHz	Pass	2.40225G	5.26	-24.74	944.15M	-52.45	2.3978G	-52.26	2.4835G	-56.26	2.48795G	-51.28	23.4843G	-46.58	1
2480MHz	Pass	2.40225G	5.26	-24.74	807.85M	-52.53	2.39407G	-52.47	2.4835G	-52.04	2.48694G	-51.14	16.20668G	-44.50	1
BT-LE(2Mbps)	-	-	-	-	-	-	-	-	-	-	-	-	-	-	-
2402MHz	Pass	2.40154G	4.19	-25.81	695.05M	-52.89	2.4G	-26.99	2.4G	-26.26	2.48542G	-52.18	16.45977G	-45.41	1
2440MHz	Pass	2.40154G	4.19	-25.81	2.09594G	-52.84	2.39522G	-52.20	2.4835G	-55.82	2.48848G	-52.07	17.34557G	-45.95	1
2480MHz	Pass	2.40154G	4.19	-25.81	878.94M	-52.52	2.39003G	-51.84	2.4835G	-52.90	2.48391G	-48.96	16.85345G	-45.60	1

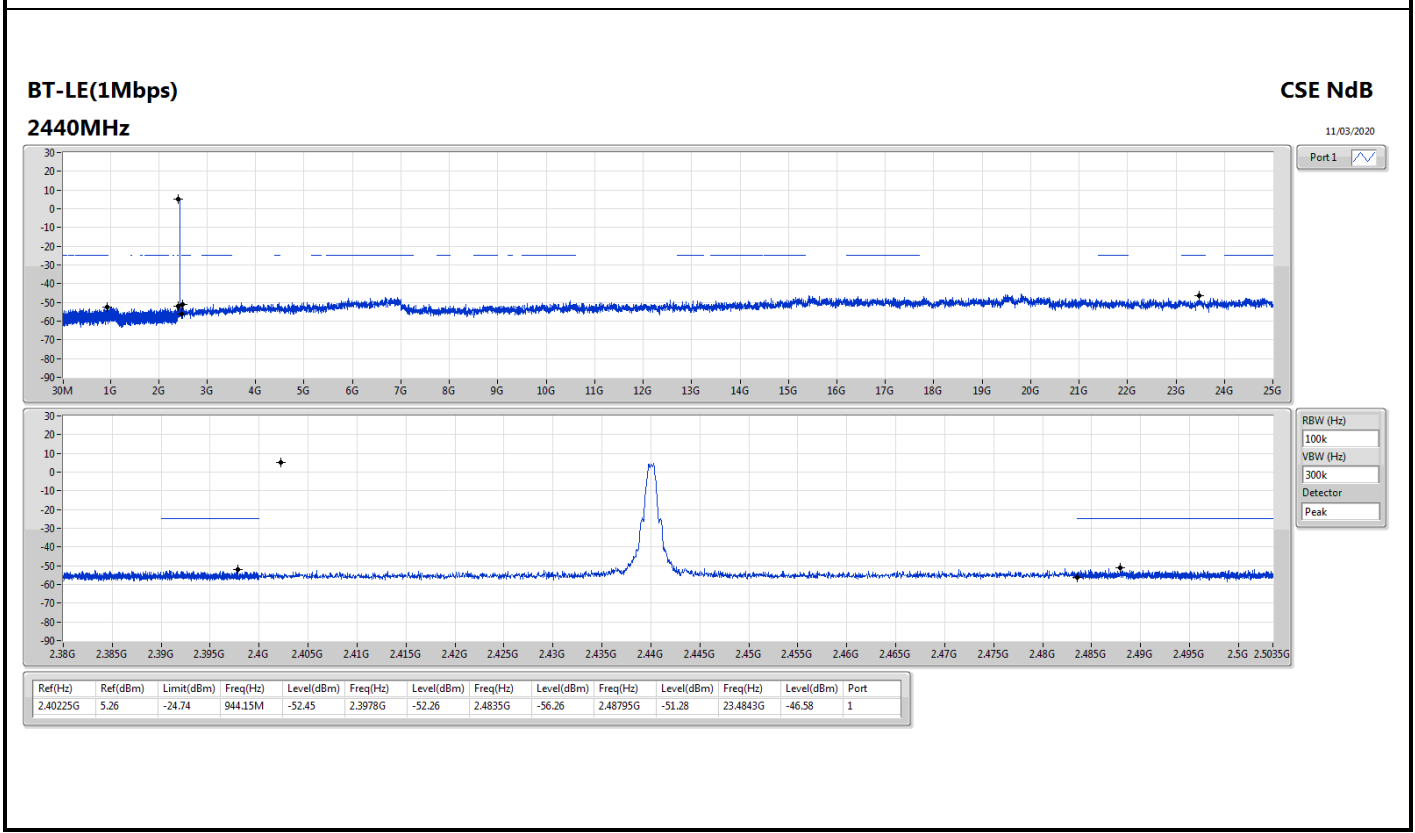
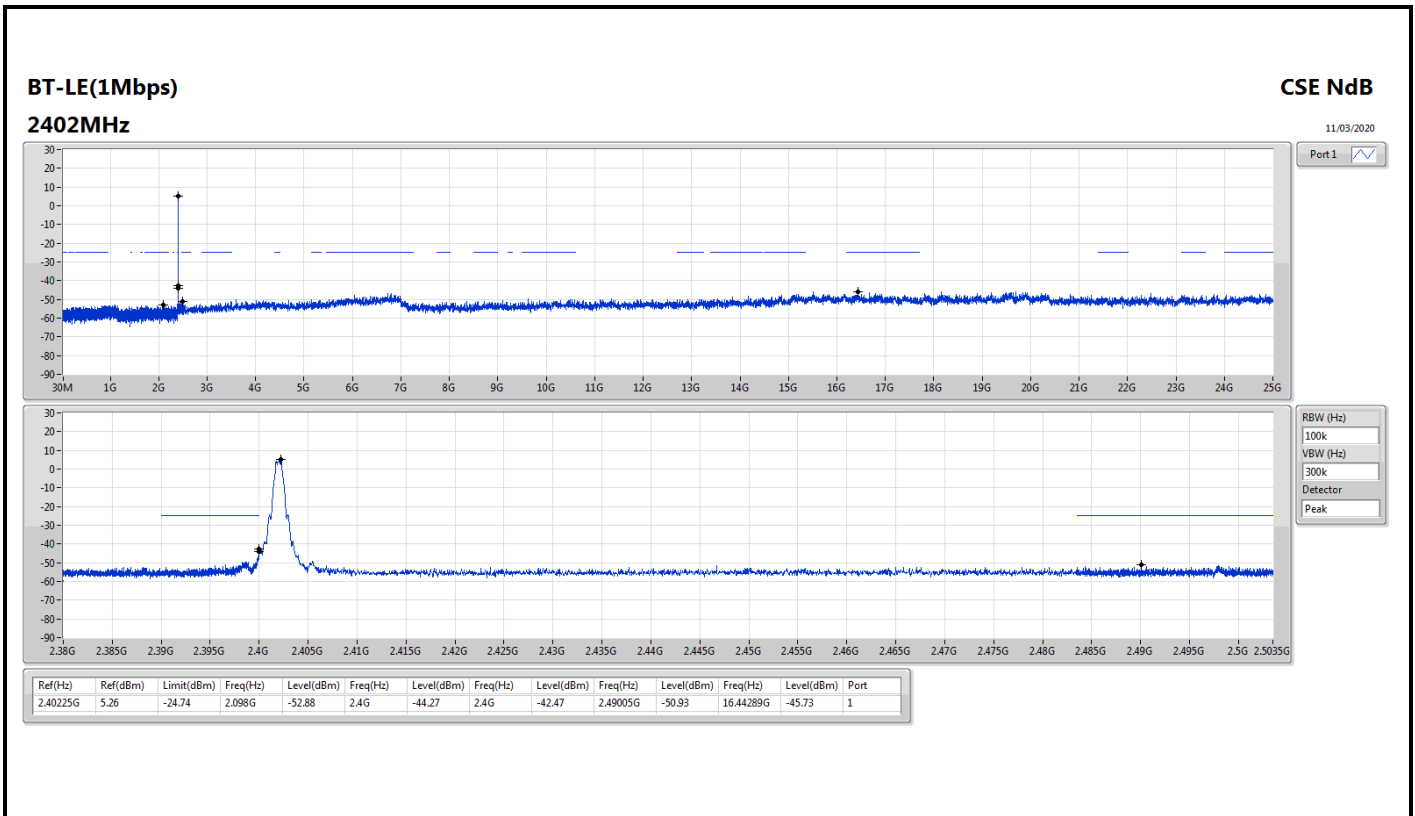

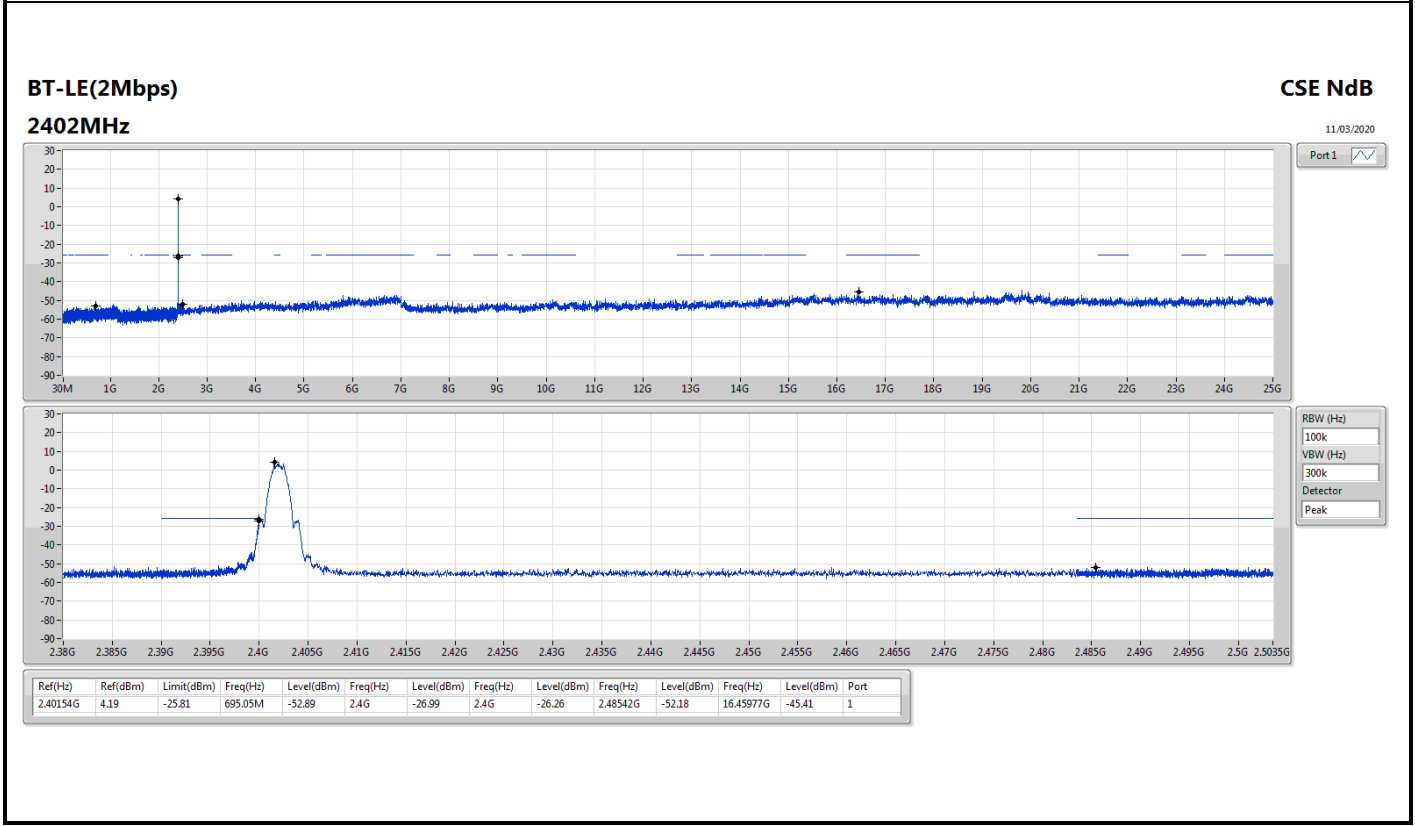
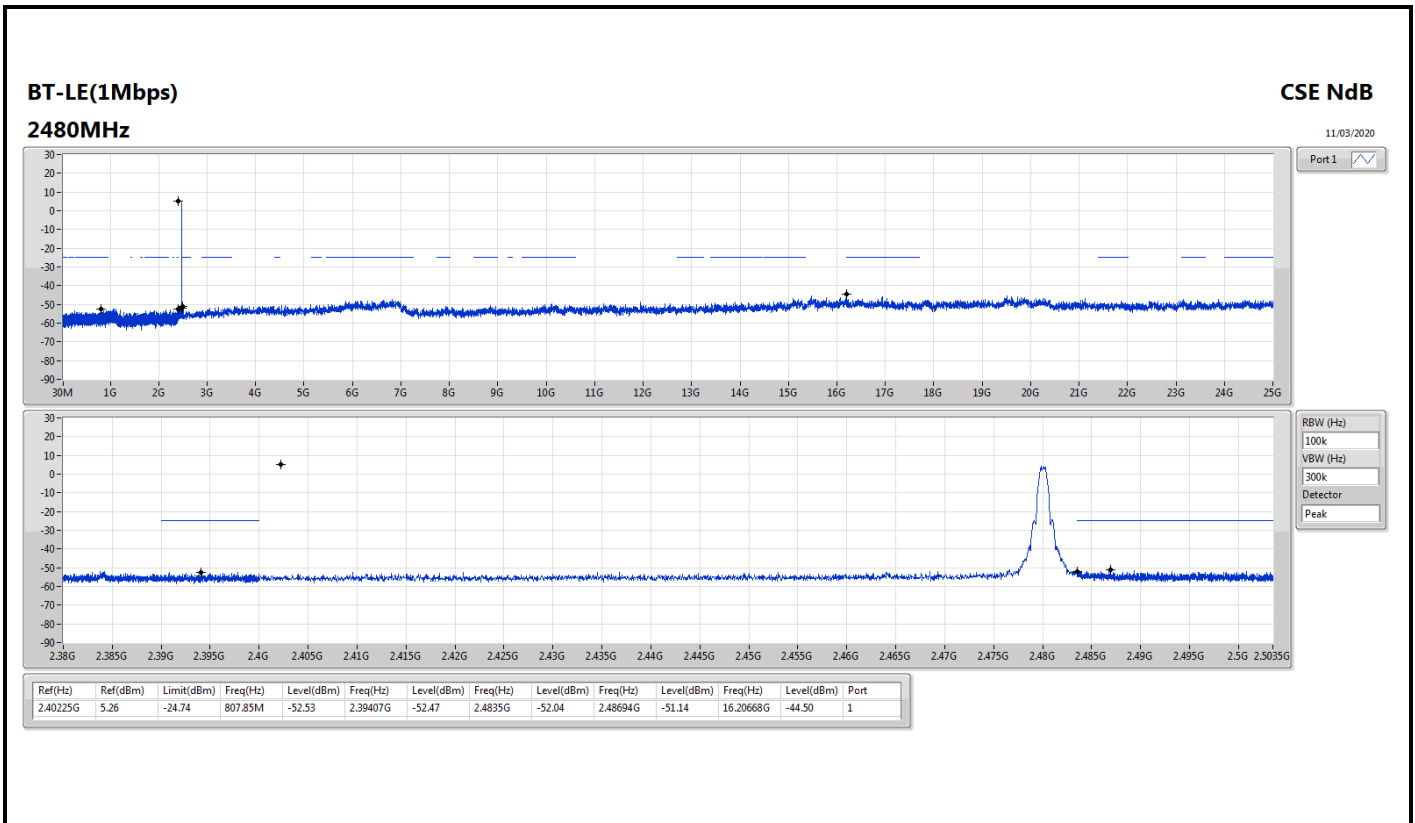



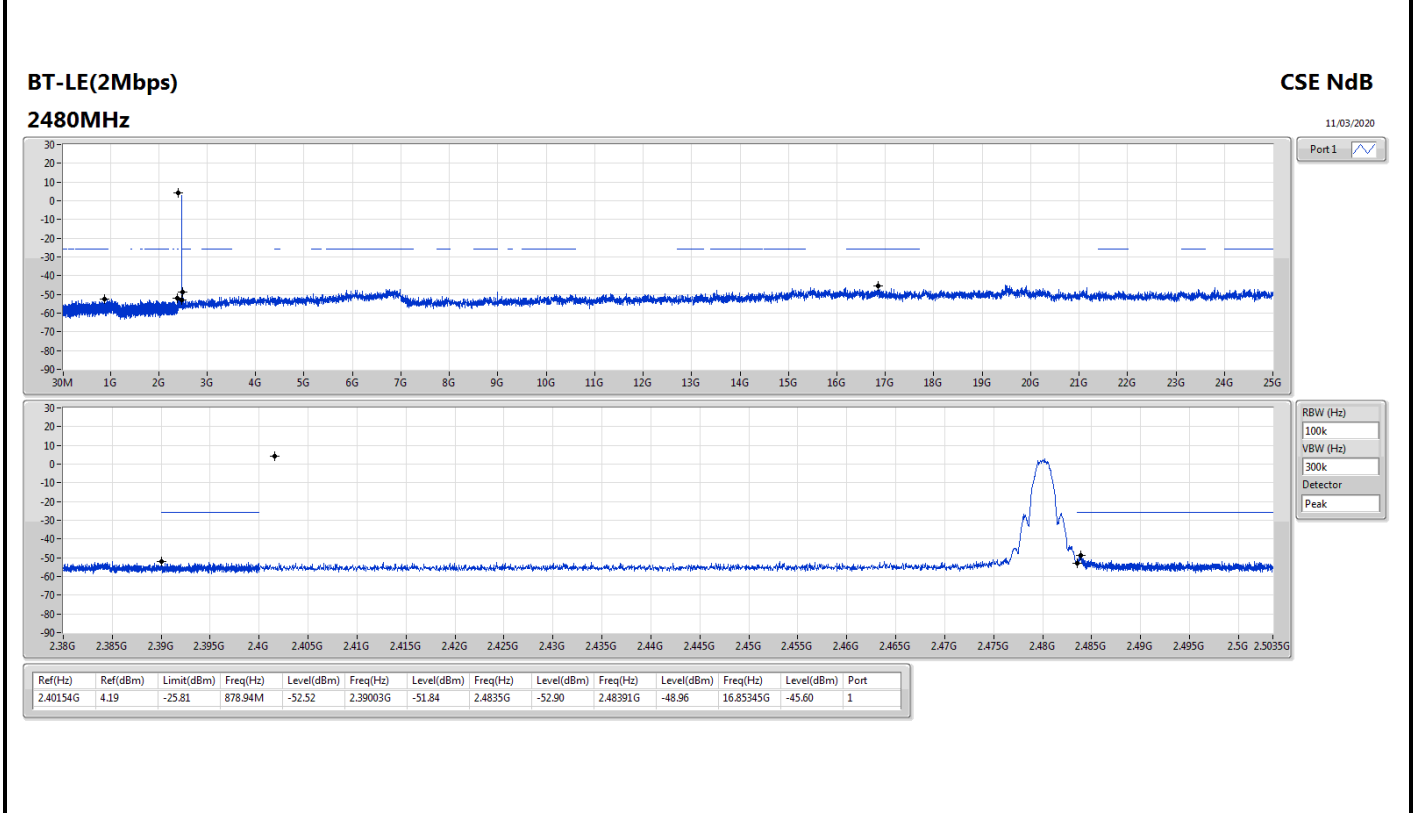
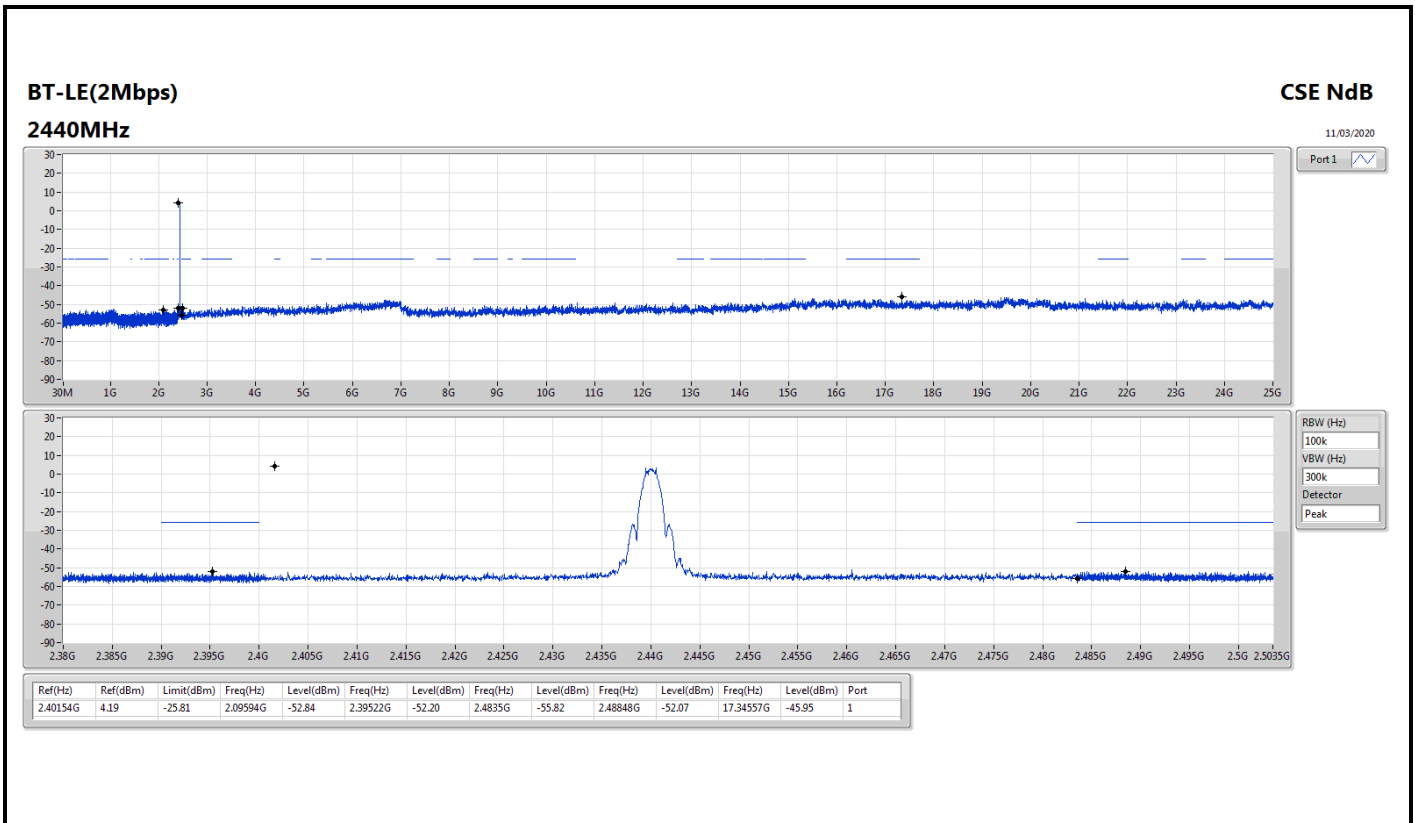

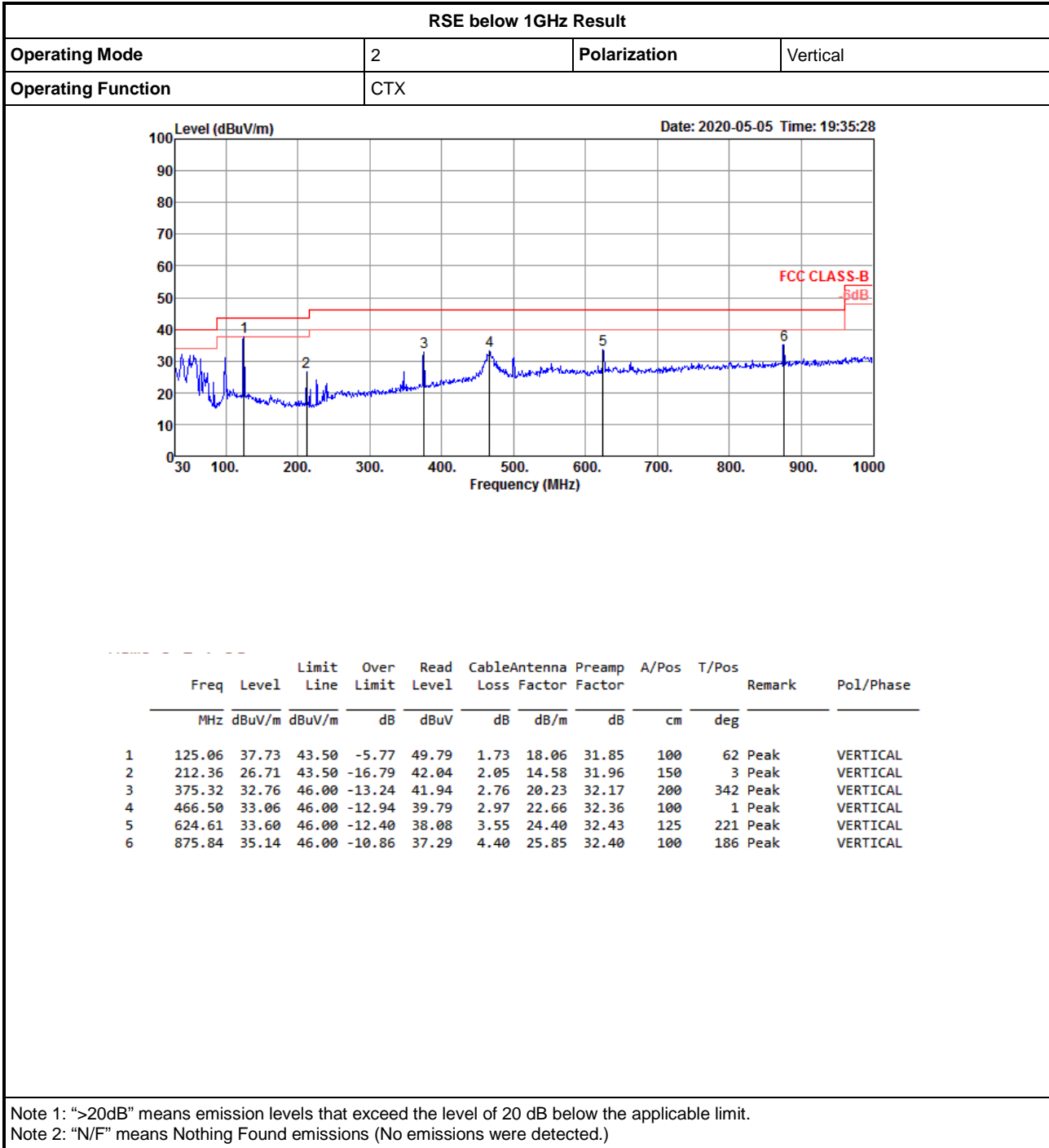

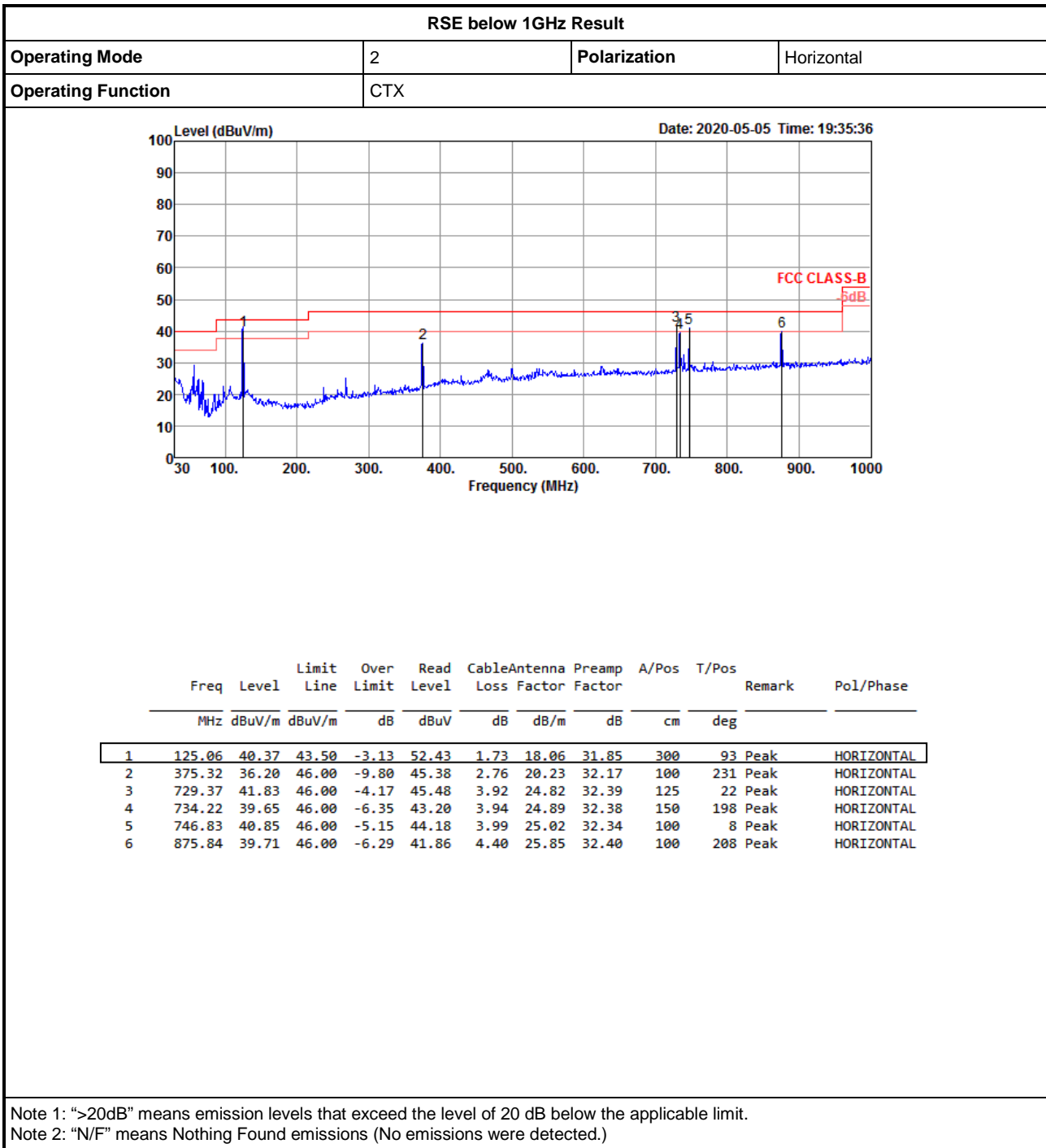



For Radiated Cabinet:

Summary

Mode	Result	Type	Freq (Hz)	Level (dBuV/m)	Limit (dBuV/m)	Margin (dB)	Dist (m)	Condition	Azimuth (°)	Height (m)	Comments
2.4-2.4835GHz	-	-	-	-	-	-	-	-	-	-	-
BT-LE(1Mbps)	Pass	AV	4.8043G	34.96	54.00	-19.04	3	Vertical	173	1.95	-

**BT-LE(1Mbps)**

11/03/2020

**2402MHz\_TX**

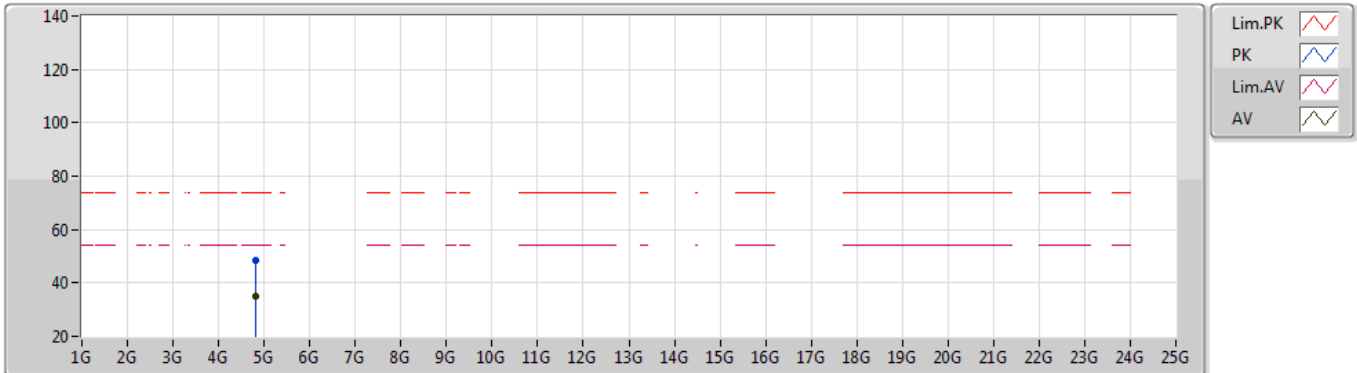

EUT Y\_1TX  
Setting 5  
02-D-S-5

Type	Freq (Hz)	Level (dBuV/m)	Limit (dBuV/m)	Margin (dB)	Raw (dBuV)	Dist (m)	Condition	Azimuth (°)	Height (m)	Comment	AF (dB)	CL (dB)	PA (dB)
PK	4.80446G	48.29	74.00	-25.71	40.15	3	Vertical	173	1.95	-	32.72	5.80	30.38
AV	4.8043G	34.96	54.00	-19.04	26.82	3	Vertical	173	1.95	-	32.72	5.80	30.38

**BT-LE(1Mbps)**

11/03/2020

**2402MHz\_TX**

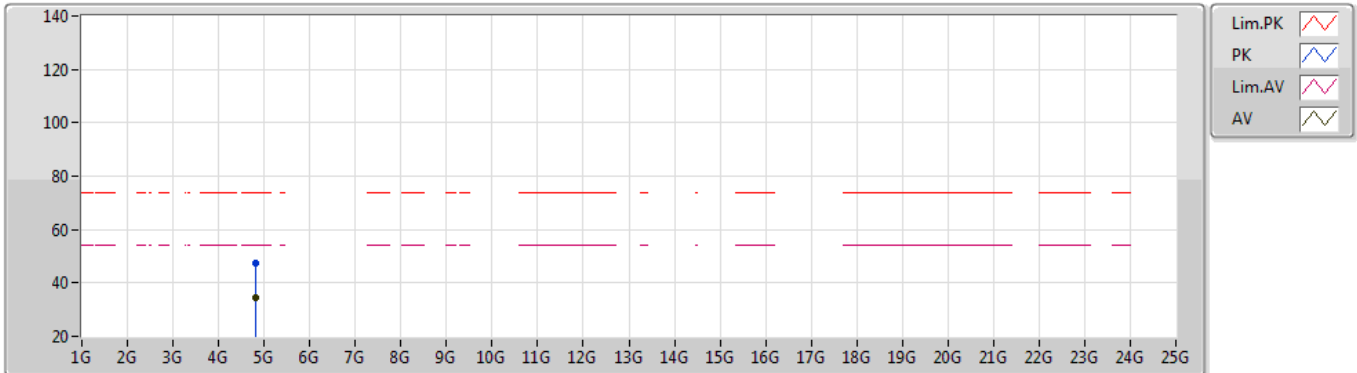

EUT Y\_1TX  
Setting 5  
02-D-S-5

Type	Freq (Hz)	Level (dBuV/m)	Limit (dBuV/m)	Margin (dB)	Raw (dBuV)	Dist (m)	Condition	Azimuth (°)	Height (m)	Comment	AF (dB)	CL (dB)	PA (dB)
PK	4.8035G	47.28	74.00	-26.72	39.15	3	Horizontal	97	2.01	-	32.71	5.80	30.38
AV	4.80368G	34.28	54.00	-19.72	26.15	3	Horizontal	97	2.01	-	32.71	5.80	30.38



For Conducted Harmonic (1~3GHz):

Summary

Mode	Result	F-Start (Hz)	F-Stop (Hz)	Type	Freq (Hz)	DG (dBi)	Psum (dBm)	EIRP (dBm)	Limit (dBm)	Margin (dB)
2.4-2.4835GHz	-	-	-	-	-	-	-	-	-	-
BT-LE(1Mbps)	Pass	1G	2.38G	AV	2.34395G	2.70	-57.77	-55.07	-41.20	-13.87
BT-LE(2Mbps)	Pass	1G	2.38G	AV	2.34412G	2.70	-58.93	-56.23	-41.20	-15.03

DG = Directional Gain;  
PX=Port X; Psum=P1+.P2+...PX



Result

Mode	Result	F-Start (Hz)	F-Stop (Hz)	Type	Freq (Hz)	DG (dBi)	Psum (dBm)	EIRP (dBm)	Limit (dBm)	Margin (dB)
BT-LE(1Mbps)	-	-	-	-	-	-	-	-	-	-
2402MHz	Pass	1G	2.38G	AV	2.35413G	2.47	-66.30	-63.83	-41.20	-22.63
2402MHz	Pass	2.38G	2.4G	AV	2.38036G	2.47	-73.32	-70.85	-41.20	-29.65
2402MHz	Pass	2.4G	2.4835G	AV	2.4835G	2.47	-77.55	-75.08	-41.20	-33.88
2402MHz	Pass	2.4835G	2.5035G	AV	2.49798G	2.47	-61.87	-59.40	-41.20	-18.20
2402MHz	Pass	2.5035G	3G	AV	2.55216G	2.47	-72.69	-70.22	-41.20	-29.02
2402MHz	Pass	1G	2.38G	PK	2.35395G	2.47	-58.09	-55.62	-21.20	-34.42
2402MHz	Pass	2.38G	2.4G	PK	2.38012G	2.47	-62.72	-60.25	-21.20	-39.05
2402MHz	Pass	2.4G	2.4835G	PK	2.4835G	2.47	-68.61	-66.14	-21.20	-44.94
2402MHz	Pass	2.4835G	2.5035G	PK	2.49778G	2.47	-57.18	-54.71	-21.20	-33.51
2402MHz	Pass	2.5035G	3G	PK	2.51033G	2.47	-63.59	-61.12	-21.20	-39.92
2440MHz	Pass	1G	2.38G	AV	2.34395G	2.70	-57.77	-55.07	-41.20	-13.87
2440MHz	Pass	2.38G	2.4G	AV	2.38064G	2.70	-72.21	-69.51	-41.20	-28.31
2440MHz	Pass	2.4G	2.4835G	AV	2.4835G	2.70	-78.07	-75.37	-41.20	-34.17
2440MHz	Pass	2.4835G	2.5035G	AV	2.50258G	2.70	-68.91	-66.21	-41.20	-25.01
2440MHz	Pass	2.5035G	3G	AV	2.53602G	2.70	-58.27	-55.57	-41.20	-14.37
2440MHz	Pass	1G	2.38G	PK	2.34447G	2.70	-54.94	-52.24	-21.20	-31.04
2440MHz	Pass	2.38G	2.4G	PK	2.3806G	2.70	-60.00	-57.30	-21.20	-36.10
2440MHz	Pass	2.4G	2.4835G	PK	2.4835G	2.70	-68.16	-65.46	-21.20	-44.26
2440MHz	Pass	2.4835G	2.5035G	PK	2.50058G	2.70	-54.46	-51.76	-21.20	-30.56
2440MHz	Pass	2.5035G	3G	PK	2.53577G	2.70	-54.05	-51.35	-21.20	-30.15
2480MHz	Pass	1G	2.38G	AV	2.37327G	2.58	-74.25	-71.67	-41.20	-30.47
2480MHz	Pass	2.38G	2.4G	AV	2.38396G	2.58	-69.55	-66.97	-41.20	-25.77
2480MHz	Pass	2.4G	2.4835G	AV	2.4835G	2.58	-78.16	-75.58	-41.20	-34.38
2480MHz	Pass	2.4835G	2.5035G	AV	2.49674G	2.58	-66.20	-63.62	-41.20	-22.42
2480MHz	Pass	2.5035G	3G	AV	2.57599G	2.58	-63.16	-60.58	-41.20	-19.38
2480MHz	Pass	1G	2.38G	PK	1.04002G	2.58	-64.32	-61.74	-21.20	-40.54
2480MHz	Pass	2.38G	2.4G	PK	2.38376G	2.58	-63.22	-60.64	-21.20	-39.44
2480MHz	Pass	2.4G	2.4835G	PK	2.4835G	2.58	-68.29	-65.71	-21.20	-44.51
2480MHz	Pass	2.4835G	2.5035G	PK	2.49666G	2.58	-57.42	-54.84	-21.20	-33.64
2480MHz	Pass	2.5035G	3G	PK	2.55737G	2.58	-54.45	-51.87	-21.20	-30.67
BT-LE(2Mbps)	-	-	-	-	-	-	-	-	-	-
2402MHz	Pass	1G	2.38G	AV	2.35413G	2.47	-66.49	-64.02	-41.20	-22.82
2402MHz	Pass	2.38G	2.4G	AV	2.38068G	2.47	-71.63	-69.16	-41.20	-27.96
2402MHz	Pass	2.4G	2.4835G	AV	2.4835G	2.47	-78.33	-75.86	-41.20	-34.66
2402MHz	Pass	2.4835G	2.5035G	AV	2.49806G	2.47	-62.97	-60.50	-41.20	-19.30
2402MHz	Pass	2.5035G	3G	AV	2.50362G	2.47	-73.33	-70.86	-41.20	-29.66
2402MHz	Pass	1G	2.38G	PK	2.32911G	2.47	-58.01	-55.54	-21.20	-34.34
2402MHz	Pass	2.38G	2.4G	PK	2.38016G	2.47	-61.44	-58.97	-21.20	-37.77
2402MHz	Pass	2.4G	2.4835G	PK	2.4835G	2.47	-68.56	-66.09	-21.20	-44.89
2402MHz	Pass	2.4835G	2.5035G	PK	2.49754G	2.47	-57.72	-55.25	-21.20	-34.05
2402MHz	Pass	2.5035G	3G	PK	2.50412G	2.47	-62.70	-60.23	-21.20	-39.03
2440MHz	Pass	1G	2.38G	AV	2.34412G	2.70	-58.93	-56.23	-41.20	-15.03
2440MHz	Pass	2.38G	2.4G	AV	2.38G	2.70	-70.91	-68.21	-41.20	-27.01
2440MHz	Pass	2.4G	2.4835G	AV	2.4835G	2.70	-77.77	-75.07	-41.20	-33.87
2440MHz	Pass	2.4835G	2.5035G	AV	2.5025G	2.70	-66.85	-64.15	-41.20	-22.95
2440MHz	Pass	2.5035G	3G	AV	2.53602G	2.70	-59.26	-56.56	-41.20	-15.36
2440MHz	Pass	1G	2.38G	PK	2.34378G	2.70	-54.70	-52.00	-21.20	-30.80
2440MHz	Pass	2.38G	2.4G	PK	2.38012G	2.70	-59.64	-56.94	-21.20	-35.74
2440MHz	Pass	2.4G	2.4835G	PK	2.4835G	2.70	-69.47	-66.77	-21.20	-45.57
2440MHz	Pass	2.4835G	2.5035G	PK	2.50134G	2.70	-54.09	-51.39	-21.20	-30.19
2440MHz	Pass	2.5035G	3G	PK	2.53639G	2.70	-54.18	-51.48	-21.20	-30.28
2480MHz	Pass	1G	2.38G	AV	2.37431G	2.58	-74.10	-71.52	-41.20	-30.32





Mode	Result	F-Start (Hz)	F-Stop (Hz)	Type	Freq (Hz)	DG (dBi)	Psum (dBm)	EIRP (dBm)	Limit (dBm)	Margin (dB)
2480MHz	Pass	2.38G	2.4G	AV	2.384G	2.58	-71.08	-68.50	-41.20	-27.30
2480MHz	Pass	2.4G	2.4835G	AV	2.4835G	2.58	-77.87	-75.29	-41.20	-34.09
2480MHz	Pass	2.4835G	2.5035G	AV	2.49714G	2.58	-66.19	-63.61	-41.20	-22.41
2480MHz	Pass	2.5035G	3G	AV	2.57599G	2.58	-64.39	-61.81	-41.20	-20.61
2480MHz	Pass	1G	2.38G	PK	2.3731G	2.58	-63.05	-60.47	-21.20	-39.27
2480MHz	Pass	2.38G	2.4G	PK	2.38348G	2.58	-63.63	-61.05	-21.20	-39.85
2480MHz	Pass	2.4G	2.4835G	PK	2.4835G	2.58	-69.09	-66.51	-21.20	-45.31
2480MHz	Pass	2.4835G	2.5035G	PK	2.4973G	2.58	-56.07	-53.49	-21.20	-32.29
2480MHz	Pass	2.5035G	3G	PK	2.5277G	2.58	-56.01	-53.43	-21.20	-32.23

DG = Directional Gain;  
 PX=Port X; Psum=P1+.P2+...PX

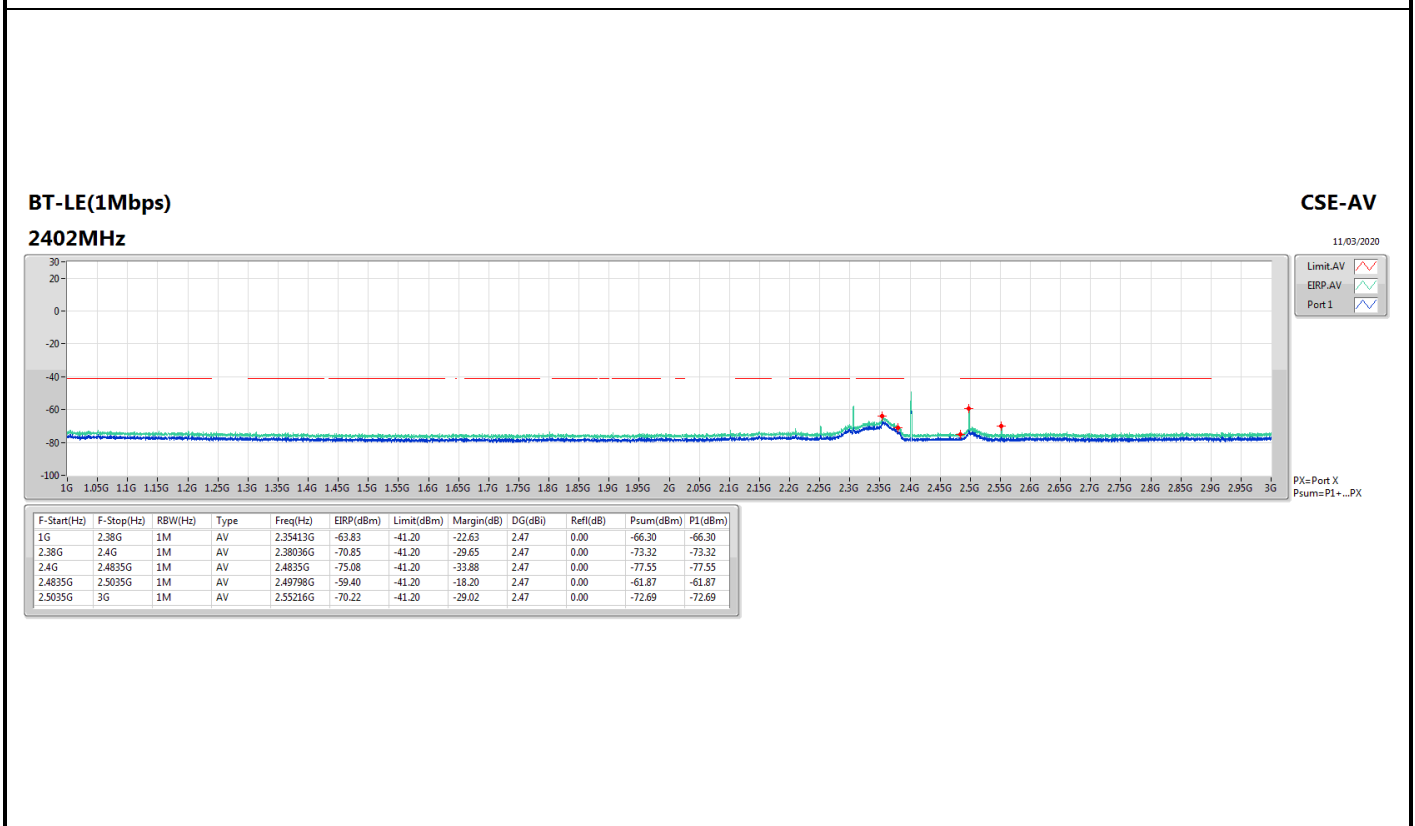
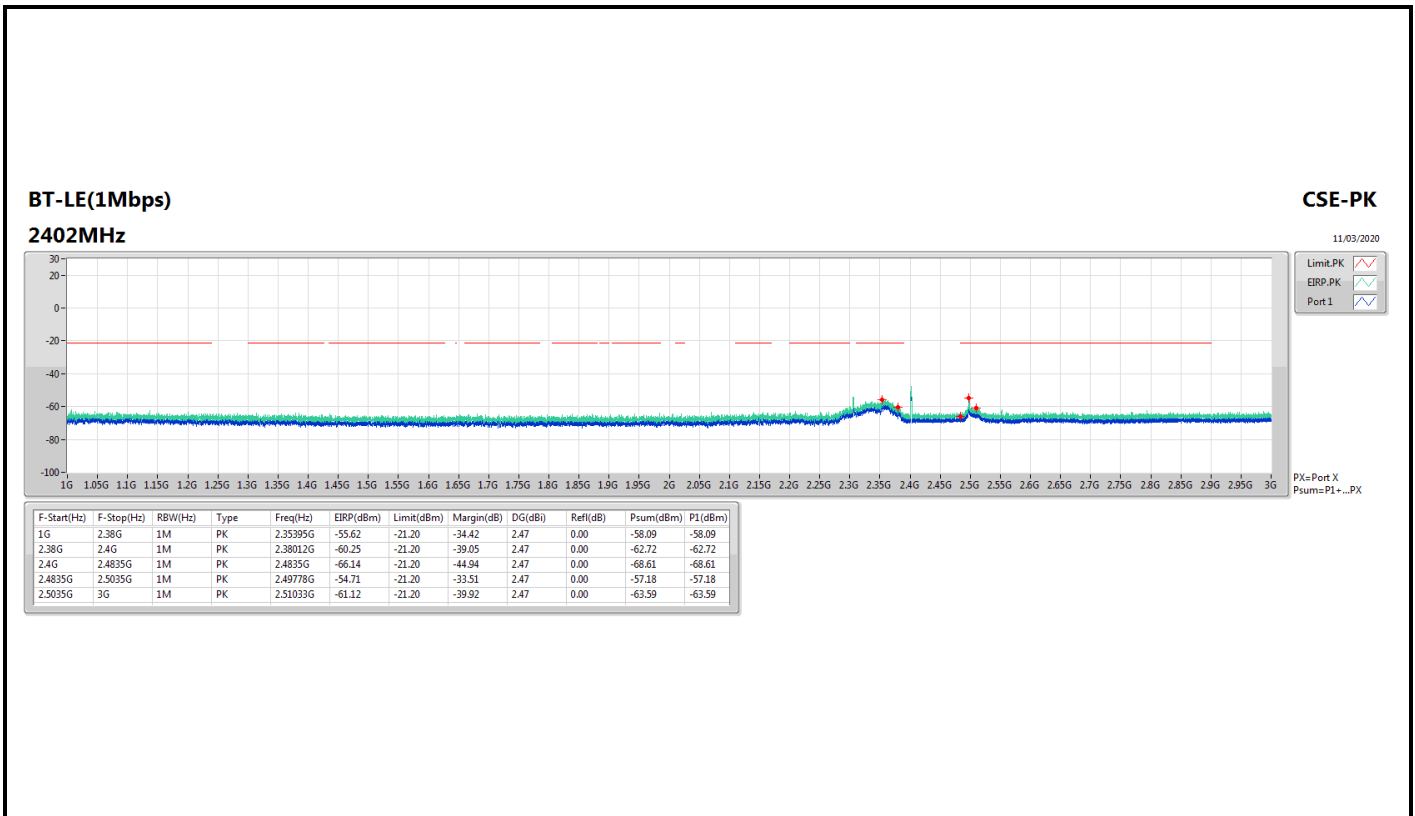

**BT-LE(1Mbps)**  
**2440MHz**

CSE-PK

11/03/2020

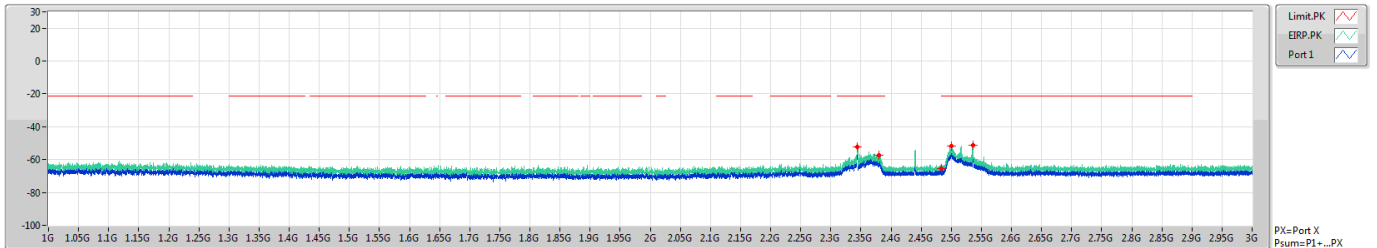

F-Start(Hz)	F-Stop(Hz)	RBW(Hz)	Type	Freq(Hz)	EIRP(dBm)	Limit(dBm)	Margin(dB)	DG(dB)	Ref(dB)	Psum(dBm)	P1(dBm)
1G	2.38G	1M	PK	2.34447G	-52.24	-21.20	-31.04	2.70	0.00	-54.94	-54.94
2.38G	2.4G	1M	PK	2.3806G	-57.30	-21.20	-36.10	2.70	0.00	-60.00	-60.00
2.4G	2.4835G	1M	PK	2.4835G	-65.46	-21.20	-44.26	2.70	0.00	-68.16	-68.16
2.4835G	2.5035G	1M	PK	2.50058G	-51.76	-21.20	-30.56	2.70	0.00	-54.46	-54.46
2.5035G	3G	1M	PK	2.53577G	-51.35	-21.20	-30.15	2.70	0.00	-54.05	-54.05

**BT-LE(1Mbps)**  
**2440MHz**

CSE-AV

11/03/2020

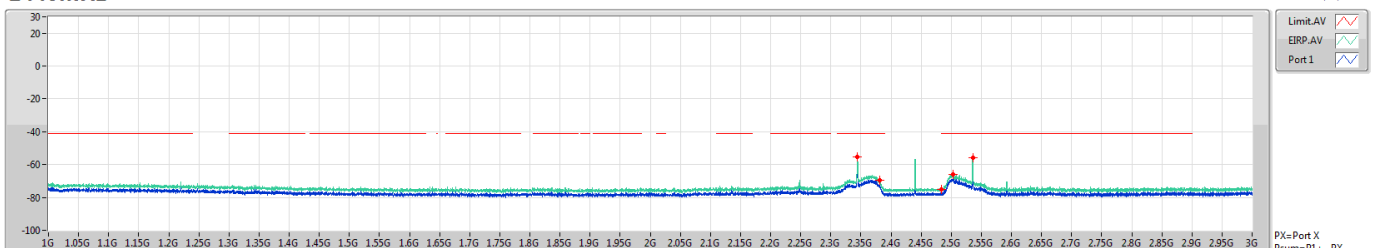

F-Start(Hz)	F-Stop(Hz)	RBW(Hz)	Type	Freq(Hz)	EIRP(dBm)	Limit(dBm)	Margin(dB)	DG(dB)	Ref(dB)	Psum(dBm)	P1(dBm)
1G	2.38G	1M	AV	2.34395G	-55.07	-41.20	-13.87	2.70	0.00	-57.77	-57.77
2.38G	2.4G	1M	AV	2.38064G	-69.51	-41.20	-28.31	2.70	0.00	-72.21	-72.21
2.4G	2.4835G	1M	AV	2.4835G	-75.37	-41.20	-34.17	2.70	0.00	-78.07	-78.07
2.4835G	2.5035G	1M	AV	2.50258G	-66.21	-41.20	-25.01	2.70	0.00	-68.91	-68.91
2.5035G	3G	1M	AV	2.53602G	-55.57	-41.20	-14.37	2.70	0.00	-58.27	-58.27

**BT-LE(1Mbps)**  
**2480MHz**

CSE-PK

11/03/2020

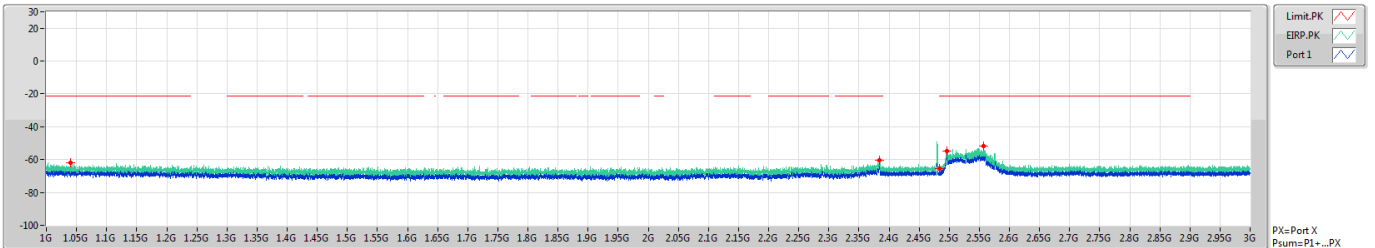

F-Start(Hz)	F-Stop(Hz)	RBW(Hz)	Type	Freq(Hz)	EIRP(dBm)	Limit(dBm)	Margin(dB)	DG(dB)	Ref(dB)	Psum(dBm)	P1(dBm)
1G	2.38G	1M	PK	1.04002G	-61.74	-21.20	-40.54	2.58	0.00	-64.32	-64.32
2.38G	2.4G	1M	PK	2.38376G	-60.64	-21.20	-39.44	2.58	0.00	-63.22	-63.22
2.4G	2.4835G	1M	PK	2.4835G	-65.71	-21.20	-44.51	2.58	0.00	-68.29	-68.29
2.4835G	2.5035G	1M	PK	2.49666G	-54.84	-21.20	-33.64	2.58	0.00	-57.42	-57.42
2.5035G	3G	1M	PK	2.55737G	-51.87	-21.20	-30.67	2.58	0.00	-54.45	-54.45

**BT-LE(1Mbps)**  
**2480MHz**

CSE-AV

11/03/2020

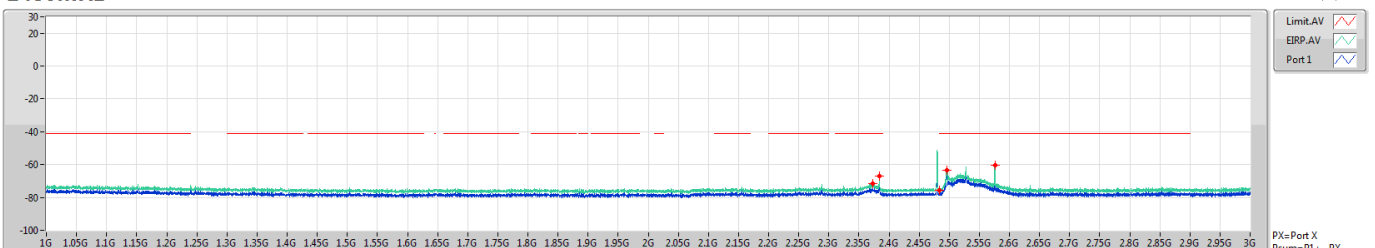

F-Start(Hz)	F-Stop(Hz)	RBW(Hz)	Type	Freq(Hz)	EIRP(dBm)	Limit(dBm)	Margin(dB)	DG(dB)	Ref(dB)	Psum(dBm)	P1(dBm)
1G	2.38G	1M	AV	2.37327G	-71.67	-41.20	-30.47	2.58	0.00	-74.25	-74.25
2.38G	2.4G	1M	AV	2.38396G	-66.97	-41.20	-25.77	2.58	0.00	-69.55	-69.55
2.4G	2.4835G	1M	AV	2.4835G	-75.58	-41.20	-34.38	2.58	0.00	-78.16	-78.16
2.4835G	2.5035G	1M	AV	2.49674G	-63.62	-41.20	-22.42	2.58	0.00	-66.20	-66.20
2.5035G	3G	1M	AV	2.57599G	-60.58	-41.20	-19.38	2.58	0.00	-63.16	-63.16

**BT-LE(2Mbps)**  
**2402MHz**

CSE-PK

11/03/2020

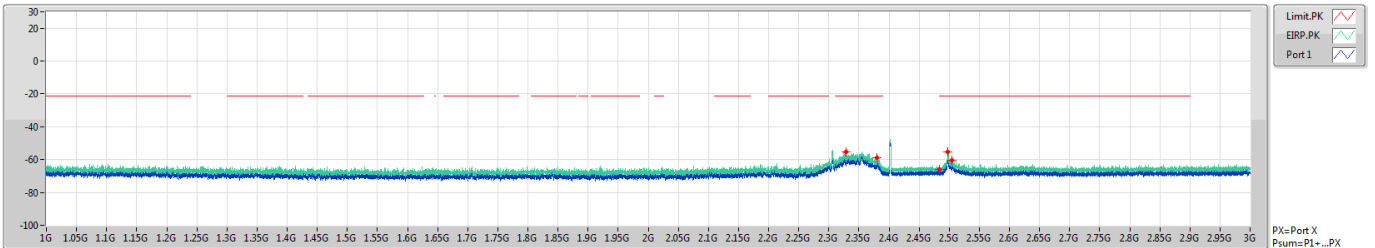

F-Start(Hz)	F-Stop(Hz)	RBW(Hz)	Type	Freq(Hz)	EIRP(dBm)	Limit(dBm)	Margin(dB)	DG(dB)	Ref(dB)	Psum(dBm)	P1(dBm)
1G	2.38G	1M	PK	2.32911G	-55.54	-21.20	-34.34	2.47	0.00	-58.01	-58.01
2.38G	2.4G	1M	PK	2.38016G	-58.97	-21.20	-37.77	2.47	0.00	-61.44	-61.44
2.4G	2.4835G	1M	PK	2.4835G	-66.09	-21.20	-44.89	2.47	0.00	-68.56	-68.56
2.4835G	2.5035G	1M	PK	2.49754G	-55.25	-21.20	-34.05	2.47	0.00	-57.72	-57.72
2.5035G	3G	1M	PK	2.50412G	-60.23	-21.20	-39.03	2.47	0.00	-62.70	-62.70

**BT-LE(2Mbps)**  
**2402MHz**

CSE-AV

11/03/2020

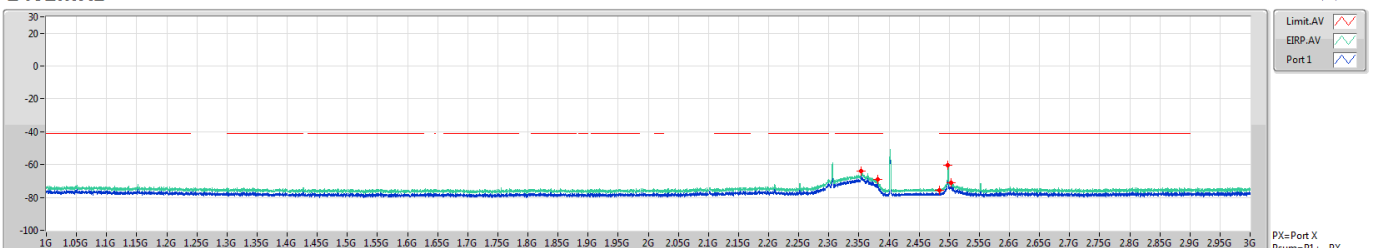

F-Start(Hz)	F-Stop(Hz)	RBW(Hz)	Type	Freq(Hz)	EIRP(dBm)	Limit(dBm)	Margin(dB)	DG(dB)	Ref(dB)	Psum(dBm)	P1(dBm)
1G	2.38G	1M	AV	2.35413G	-64.02	-41.20	-22.82	2.47	0.00	-66.49	-66.49
2.38G	2.4G	1M	AV	2.38068G	-69.16	-41.20	-27.96	2.47	0.00	-71.63	-71.63
2.4G	2.4835G	1M	AV	2.4835G	-75.86	-41.20	-34.66	2.47	0.00	-78.33	-78.33
2.4835G	2.5035G	1M	AV	2.49806G	-60.50	-41.20	-19.30	2.47	0.00	-62.97	-62.97
2.5035G	3G	1M	AV	2.50362G	-70.86	-41.20	-29.66	2.47	0.00	-73.33	-73.33

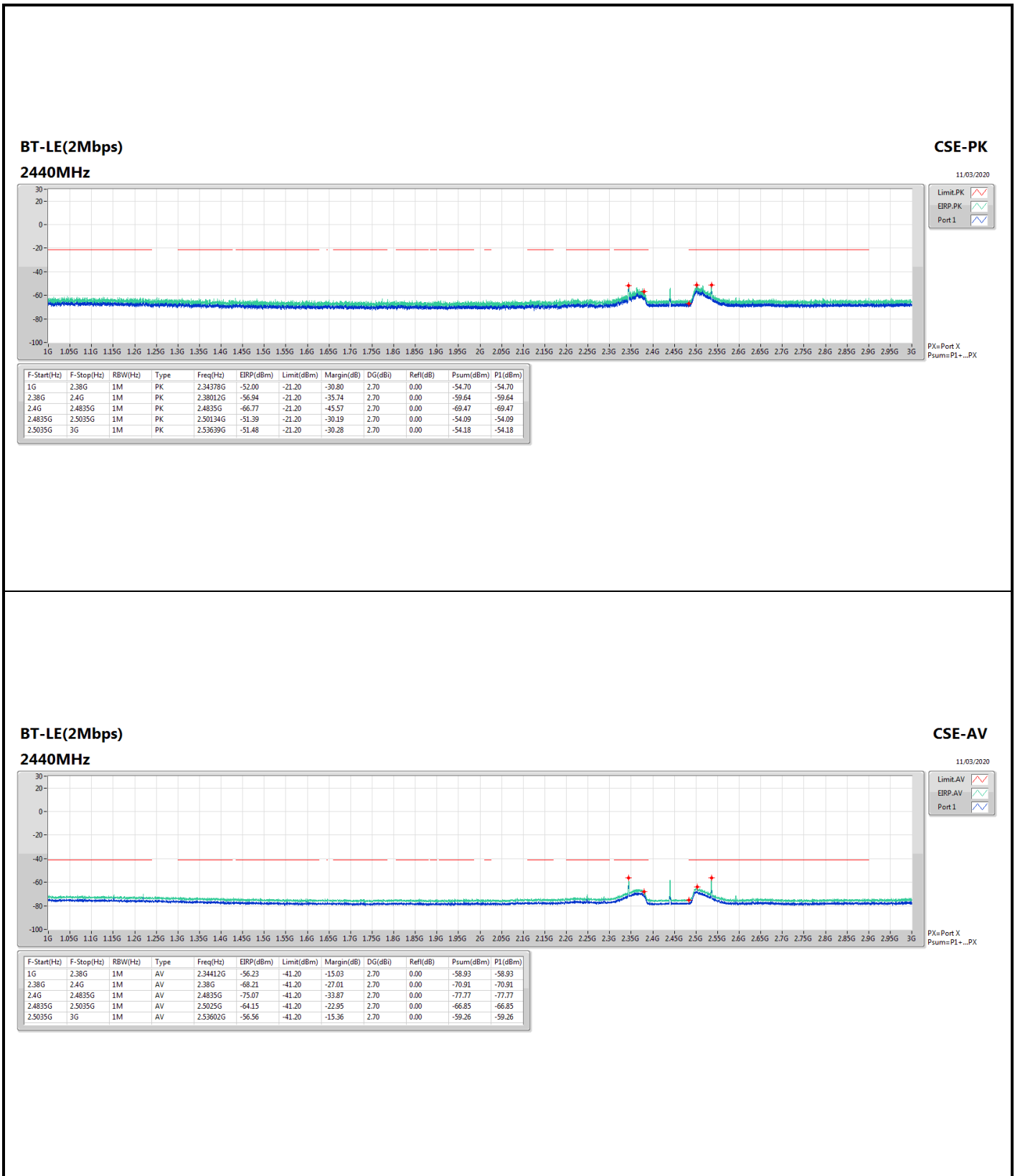

**BT-LE(2Mbps)**  
**2480MHz**

CSE-PK

11/03/2020

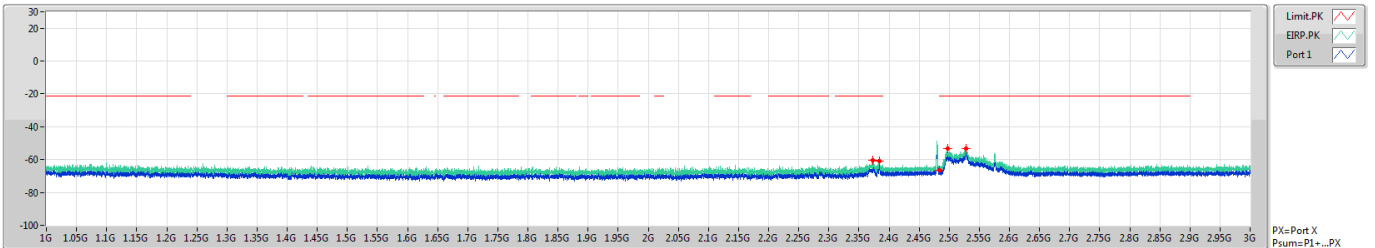

F-Start(Hz)	F-Stop(Hz)	RBW(Hz)	Type	Freq(Hz)	EIRP(dBm)	Limit(dBm)	Margin(dB)	DG(dB)	Ref(dB)	Psum(dBm)	P1(dBm)
1G	2.38G	1M	PK	2.3731G	-60.47	-21.20	-39.27	2.58	0.00	-63.05	-63.05
2.38G	2.4G	1M	PK	2.38348G	-61.05	-21.20	-39.85	2.58	0.00	-63.63	-63.63
2.4G	2.4835G	1M	PK	2.4835G	-66.51	-21.20	-45.31	2.58	0.00	-69.09	-69.09
2.4835G	2.5035G	1M	PK	2.4973G	-53.49	-21.20	-32.29	2.58	0.00	-56.07	-56.07
2.5035G	3G	1M	PK	2.5277G	-53.43	-21.20	-32.23	2.58	0.00	-56.01	-56.01

**BT-LE(2Mbps)**  
**2480MHz**

CSE-AV

11/03/2020

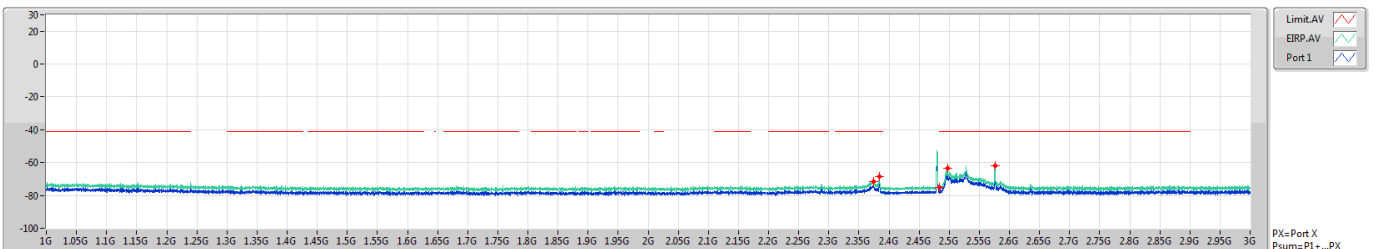

F-Start(Hz)	F-Stop(Hz)	RBW(Hz)	Type	Freq(Hz)	EIRP(dBm)	Limit(dBm)	Margin(dB)	DG(dB)	Ref(dB)	Psum(dBm)	P1(dBm)
1G	2.38G	1M	AV	2.37431G	-71.52	-41.20	-30.32	2.58	0.00	-74.10	-74.10
2.38G	2.4G	1M	AV	2.384G	-68.50	-41.20	-27.30	2.58	0.00	-71.08	-71.08
2.4G	2.4835G	1M	AV	2.4835G	-75.29	-41.20	-34.09	2.58	0.00	-77.87	-77.87
2.4835G	2.5035G	1M	AV	2.49714G	-63.61	-41.20	-22.41	2.58	0.00	-66.19	-66.19
2.5035G	3G	1M	AV	2.57599G	-61.81	-41.20	-20.61	2.58	0.00	-64.39	-64.39



For Conducted Harmonic (3~18GHz):

Summary

Mode	Result	F-Start (Hz)	F-Stop (Hz)	Type	Freq (Hz)	DG (dBi)	Psum (dBm)	EIRP (dBm)	Limit (dBm)	Margin (dB)
2.4-2.4835GHz	-	-	-	-	-	-	-	-	-	-
BT-LE(1Mbps)	Pass	3G	7.5G	AV	4.80394G	2.47	-51.75	-49.28	-41.20	-8.08
BT-LE(2Mbps)	Pass	3G	7.5G	AV	4.80281G	2.47	-55.22	-52.75	-41.20	-11.55

DG = Directional Gain;  
PX=Port X; Psum=P1+.P2+...PX





Result

Mode	Result	F-Start (Hz)	F-Stop (Hz)	Type	Freq (Hz)	DG (dBi)	Psum (dBm)	EIRP (dBm)	Limit (dBm)	Margin (dB)
BT-LE(1Mbps)	-	-	-	-	-	-	-	-	-	-
2402MHz	Pass	3G	7.5G	AV	4.80394G	2.47	-51.75	-49.28	-41.20	-8.08
2402MHz	Pass	7.5G	25G	AV	19.49844G	2.47	-79.33	-76.86	-41.20	-35.66
2402MHz	Pass	3G	7.5G	PK	4.8045G	2.47	-49.19	-46.72	-21.20	-25.52
2402MHz	Pass	7.5G	25G	PK	19.78719G	2.47	-70.19	-67.72	-21.20	-46.52
2440MHz	Pass	3G	7.5G	AV	4.87988G	2.70	-53.74	-51.04	-41.20	-9.84
2440MHz	Pass	7.5G	25G	AV	19.51813G	2.70	-79.19	-76.49	-41.20	-35.29
2440MHz	Pass	3G	7.5G	PK	4.88044G	2.70	-50.67	-47.97	-21.20	-26.77
2440MHz	Pass	7.5G	25G	PK	19.59906G	2.70	-69.99	-67.29	-21.20	-46.09
2480MHz	Pass	3G	7.5G	AV	4.95975G	2.58	-58.92	-56.34	-41.20	-15.14
2480MHz	Pass	7.5G	25G	AV	12.4G	2.58	-70.53	-67.95	-41.20	-26.75
2480MHz	Pass	3G	7.5G	PK	4.95975G	2.58	-55.68	-53.10	-21.20	-31.90
2480MHz	Pass	7.5G	25G	PK	12.39781G	2.58	-64.17	-61.59	-21.20	-40.39
BT-LE(2Mbps)	-	-	-	-	-	-	-	-	-	-
2402MHz	Pass	3G	7.5G	AV	4.80281G	2.47	-55.22	-52.75	-41.20	-11.55
2402MHz	Pass	3G	7.5G	AV	4.80338G	2.47	-55.77	-53.30	-41.20	-12.10
2402MHz	Pass	7.5G	25G	AV	19.52906G	2.47	-79.34	-76.87	-41.20	-35.67
2402MHz	Pass	3G	7.5G	PK	4.80338G	2.47	-49.54	-47.07	-21.20	-25.87
2402MHz	Pass	3G	7.5G	PK	4.80506G	2.47	-49.32	-46.85	-21.20	-25.65
2402MHz	Pass	7.5G	25G	PK	19.48313G	2.47	-70.45	-67.98	-21.20	-46.78
2440MHz	Pass	3G	7.5G	AV	4.88044G	2.70	-57.35	-54.65	-41.20	-13.45
2440MHz	Pass	3G	7.5G	AV	4.881G	2.70	-57.20	-54.50	-41.20	-13.30
2440MHz	Pass	7.5G	25G	AV	19.51813G	2.70	-78.85	-76.15	-41.20	-34.95
2440MHz	Pass	3G	7.5G	PK	4.87931G	2.70	-50.69	-47.99	-21.20	-26.79
2440MHz	Pass	3G	7.5G	PK	4.88044G	2.70	-52.16	-49.46	-21.20	-28.26
2440MHz	Pass	7.5G	25G	PK	15.49531G	2.70	-69.85	-67.15	-21.20	-45.95
2480MHz	Pass	3G	7.5G	AV	4.96031G	2.58	-62.91	-60.33	-41.20	-19.13
2480MHz	Pass	3G	7.5G	AV	4.96088G	2.58	-62.35	-59.77	-41.20	-18.57
2480MHz	Pass	7.5G	25G	AV	12.39781G	2.58	-71.11	-68.53	-41.20	-27.33
2480MHz	Pass	3G	7.5G	PK	4.95919G	2.58	-55.88	-53.30	-21.20	-32.10
2480MHz	Pass	3G	7.5G	PK	4.95975G	2.58	-57.40	-54.82	-21.20	-33.62
2480MHz	Pass	7.5G	25G	PK	12.39781G	2.58	-64.48	-61.90	-21.20	-40.70

DG = Directional Gain;  
 PX=Port X; Psum=P1+.P2+...PX





**BT-LE(1Mbps)**  
**2480MHz**

**CSE-PK**

11/03/2020

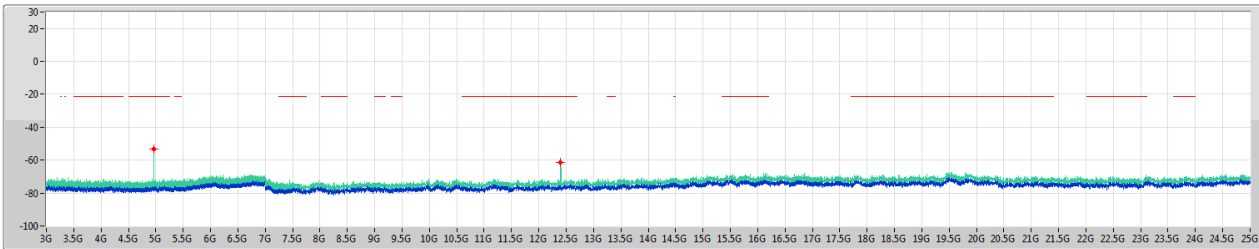

PX=Port X  
Psum=P1+...PX

F-Start(Hz)	F-Stop(Hz)	RBW(Hz)	Type	Freq(Hz)	EIRP(dBm)	Limit(dBm)	Margin(dB)	DG(dBi)	Ref(dB)	Psum(dBm)	P1(dBm)
3G	7.5G	1M	PK	4.95975G	-53.10	-21.20	-31.90	2.58	0.00	-55.68	-55.68
7.5G	25G	1M	PK	12.39781G	-61.59	-21.20	-40.39	2.58	0.00	-64.17	-64.17

**BT-LE(1Mbps)**  
**2480MHz**

**CSE-AV**

11/03/2020

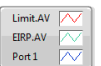
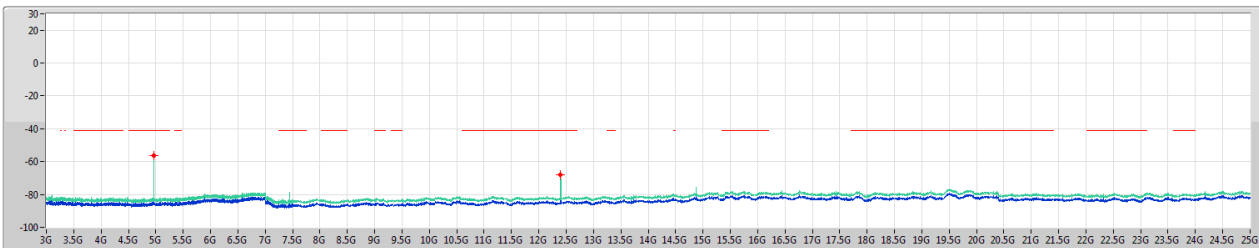

PX=Port X  
Psum=P1+...PX

F-Start(Hz)	F-Stop(Hz)	RBW(Hz)	Type	Freq(Hz)	EIRP(dBm)	Limit(dBm)	Margin(dB)	DG(dBi)	Ref(dB)	Psum(dBm)	P1(dBm)
3G	7.5G	1M	AV	4.95975G	-56.34	-41.20	-15.14	2.58	0.00	-58.92	-58.92
7.5G	25G	1M	AV	12.4G	-67.95	-41.20	-26.75	2.58	0.00	-70.53	-70.53

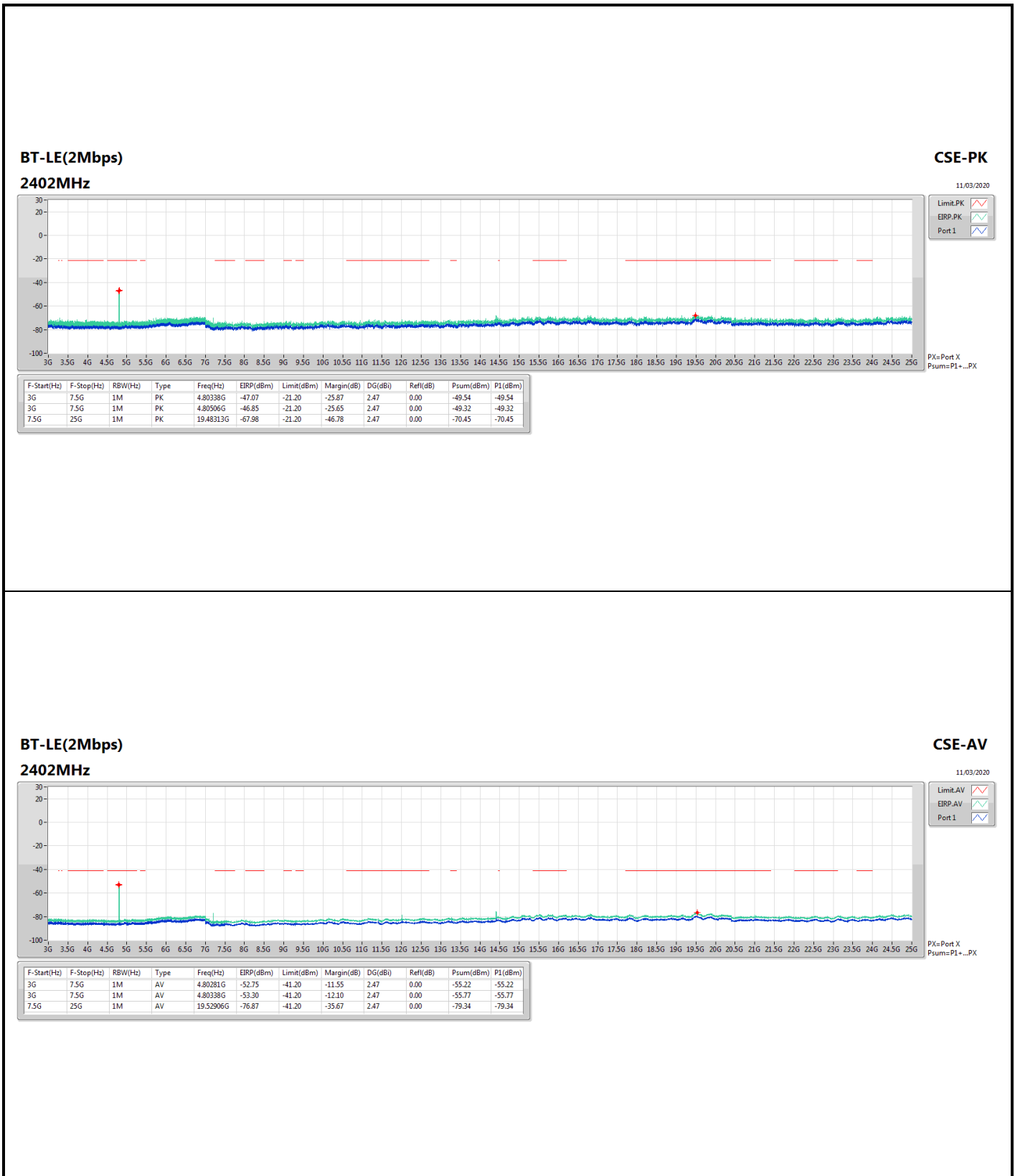

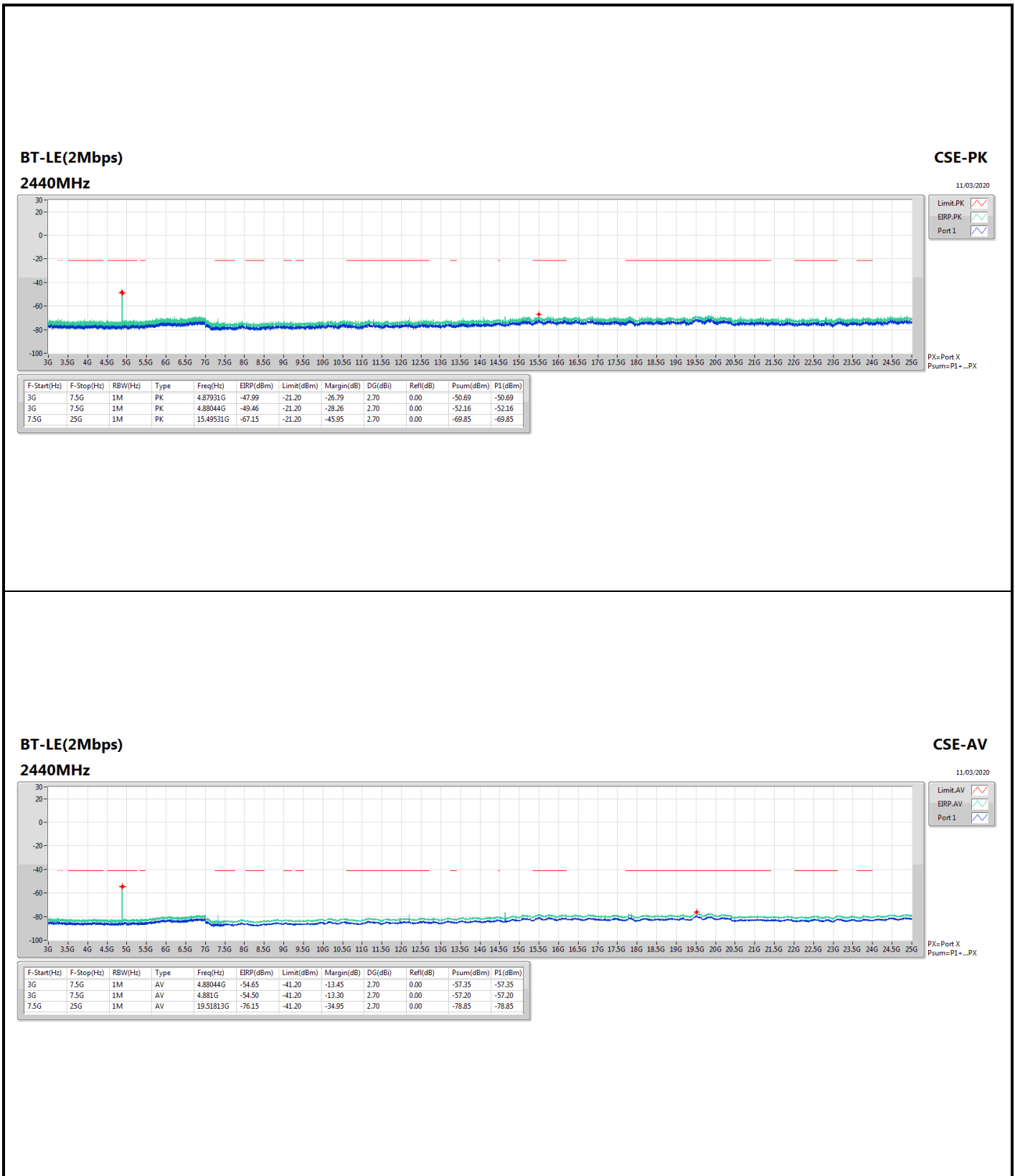

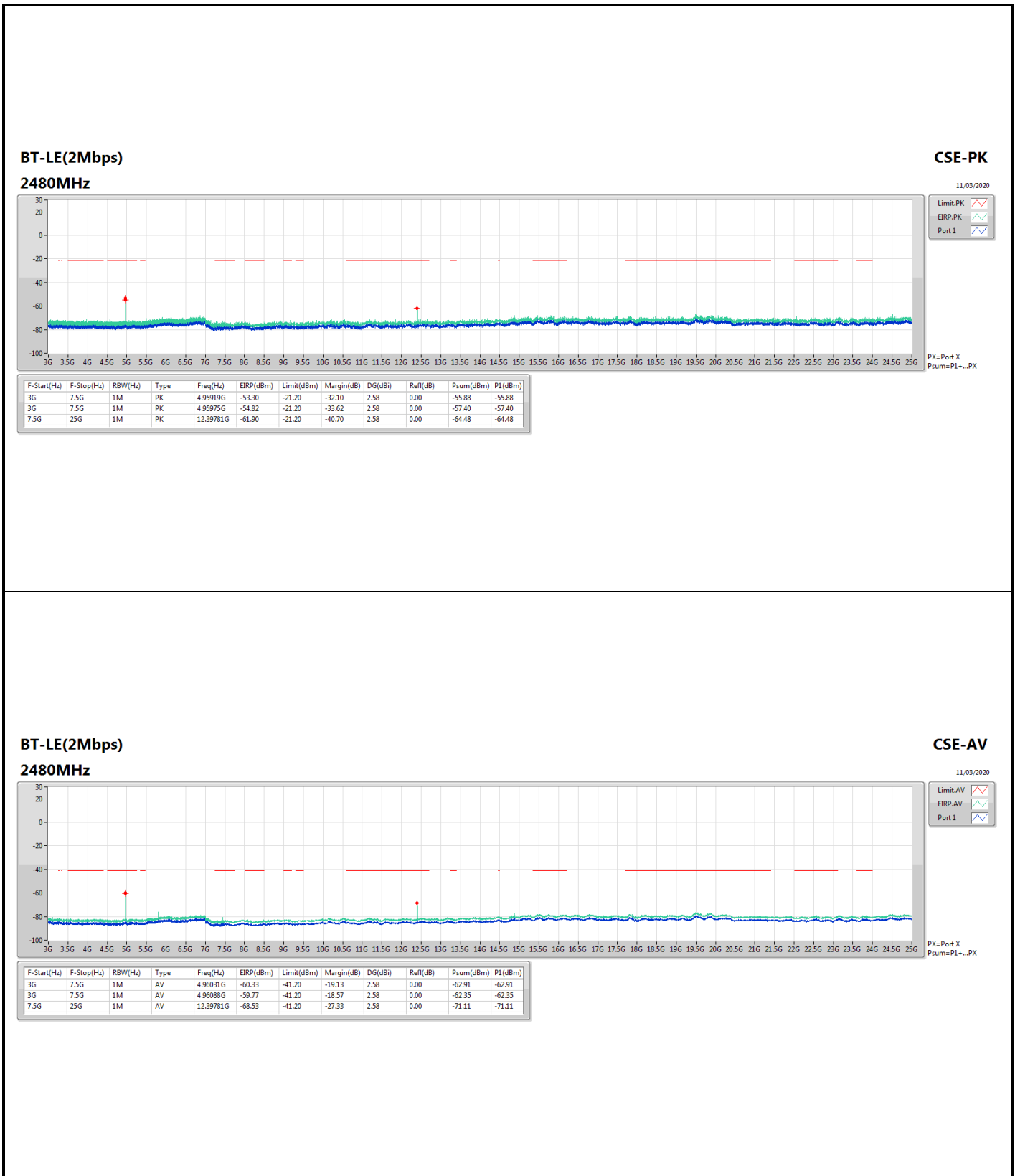



For Conducted Bandedge:

Summary

Mode	Result	F-Start (Hz)	F-Stop (Hz)	Type	Freq (Hz)	DG (dBi)	Psum (dBm)	EIRP (dBm)	Limit (dBm)	Margin (dB)
2.4-2.4835GHz	-	-	-	-	-	-	-	-	-	-
BT-LE(1Mbps)	Pass	2.4835G	2.5035G	AV	2.4835G	2.58	-55.90	-53.32	-41.20	-12.12
BT-LE(2Mbps)	Pass	2.4G	2.4835G	AV	2.4835G	2.58	-50.84	-48.26	-41.20	-7.06

DG = Directional Gain;  
PX=Port X; Psum=P1+.P2+...PX





Result

Mode	Result	F-Start (Hz)	F-Stop (Hz)	Type	Freq (Hz)	DG (dBi)	Psum (dBm)	EIRP (dBm)	Limit (dBm)	Margin (dB)
BT-LE(1Mbps)	-	-	-	-	-	-	-	-	-	-
2402MHz	Pass	2.3G	2.38G	AV	2.3542G	2.47	-63.21	-60.74	-41.20	-19.54
2402MHz	Pass	2.38G	2.4G	AV	2.38836G	2.47	-60.99	-58.52	-41.20	-17.32
2402MHz	Pass	2.4G	2.4835G	AV	2.4835G	2.47	-64.41	-61.94	-41.20	-20.74
2402MHz	Pass	2.4835G	2.5035G	AV	2.4981G	2.47	-56.97	-54.50	-41.20	-13.30
2402MHz	Pass	2.5035G	2.6G	AV	2.50968G	2.47	-64.35	-61.88	-41.20	-20.68
2402MHz	Pass	2.3G	2.38G	PK	2.35657G	2.47	-52.59	-50.12	-21.20	-28.92
2402MHz	Pass	2.38G	2.4G	PK	2.3832G	2.47	-52.11	-49.64	-21.20	-28.44
2402MHz	Pass	2.4G	2.4835G	PK	2.4835G	2.47	-54.08	-51.61	-21.20	-30.41
2402MHz	Pass	2.4835G	2.5035G	PK	2.4979G	2.47	-50.74	-48.27	-21.20	-27.07
2402MHz	Pass	2.5035G	2.6G	PK	2.57175G	2.47	-53.51	-51.04	-21.20	-29.84
2440MHz	Pass	2.3G	2.38G	AV	2.34408G	2.70	-57.61	-54.91	-41.20	-13.71
2440MHz	Pass	2.38G	2.4G	AV	2.38688G	2.70	-63.22	-60.52	-41.20	-19.32
2440MHz	Pass	2.4G	2.4835G	AV	2.4835G	2.70	-63.17	-60.47	-41.20	-19.27
2440MHz	Pass	2.4835G	2.5035G	AV	2.48794G	2.70	-59.18	-56.48	-41.20	-15.28
2440MHz	Pass	2.5035G	2.6G	AV	2.53612G	2.70	-58.12	-55.42	-41.20	-14.22
2440MHz	Pass	2.3G	2.38G	PK	2.34357G	2.70	-51.18	-48.48	-21.20	-27.28
2440MHz	Pass	2.38G	2.4G	PK	2.38304G	2.70	-52.93	-50.23	-21.20	-29.03
2440MHz	Pass	2.4G	2.4835G	PK	2.4835G	2.70	-52.43	-49.73	-21.20	-28.53
2440MHz	Pass	2.4835G	2.5035G	PK	2.48562G	2.70	-50.20	-47.50	-21.20	-26.30
2440MHz	Pass	2.5035G	2.6G	PK	2.53631G	2.70	-50.62	-47.92	-21.20	-26.72
2480MHz	Pass	2.3G	2.38G	AV	2.3174G	2.58	-63.94	-61.36	-41.20	-20.16
2480MHz	Pass	2.38G	2.4G	AV	2.38404G	2.58	-57.22	-54.64	-41.20	-13.44
2480MHz	Pass	2.4G	2.4835G	AV	2.4835G	2.58	-56.15	-53.57	-41.20	-12.37
2480MHz	Pass	2.4835G	2.5035G	AV	2.4835G	2.58	-55.90	-53.32	-41.20	-12.12
2480MHz	Pass	2.5035G	2.6G	AV	2.57602G	2.58	-58.36	-55.78	-41.20	-14.58
2480MHz	Pass	2.3G	2.38G	PK	2.37949G	2.58	-52.85	-50.27	-21.20	-29.07
2480MHz	Pass	2.38G	2.4G	PK	2.38384G	2.58	-50.49	-47.91	-21.20	-26.71
2480MHz	Pass	2.4G	2.4835G	PK	2.4835G	2.58	-46.58	-44.00	-21.20	-22.80
2480MHz	Pass	2.4835G	2.5035G	PK	2.48378G	2.58	-46.15	-43.57	-21.20	-22.37
2480MHz	Pass	2.5035G	2.6G	PK	2.52835G	2.58	-50.39	-47.81	-21.20	-26.61
BT-LE(2Mbps)	-	-	-	-	-	-	-	-	-	-
2402MHz	Pass	2.3G	2.38G	AV	2.36762G	2.47	-63.49	-61.02	-41.20	-19.82
2402MHz	Pass	2.38G	2.4G	AV	2.38892G	2.47	-61.54	-59.07	-41.20	-17.87
2402MHz	Pass	2.4G	2.4835G	AV	2.4835G	2.47	-64.15	-61.68	-41.20	-20.48
2402MHz	Pass	2.4835G	2.5035G	AV	2.49826G	2.47	-58.57	-56.10	-41.20	-14.90
2402MHz	Pass	2.5035G	2.6G	AV	2.5222G	2.47	-63.88	-61.41	-41.20	-20.21
2402MHz	Pass	2.3G	2.38G	PK	2.32522G	2.47	-52.47	-50.00	-21.20	-28.80
2402MHz	Pass	2.38G	2.4G	PK	2.38912G	2.47	-50.22	-47.75	-21.20	-26.55
2402MHz	Pass	2.4G	2.4835G	PK	2.4835G	2.47	-54.89	-52.42	-21.20	-31.22
2402MHz	Pass	2.4835G	2.5035G	PK	2.4985G	2.47	-50.64	-48.17	-21.20	-26.97
2402MHz	Pass	2.5035G	2.6G	PK	2.51513G	2.47	-52.99	-50.52	-21.20	-29.32
2440MHz	Pass	2.3G	2.38G	AV	2.34415G	2.70	-59.78	-57.08	-41.20	-15.88
2440MHz	Pass	2.38G	2.4G	AV	2.38984G	2.70	-63.15	-60.45	-41.20	-19.25
2440MHz	Pass	2.4G	2.4835G	AV	2.4835G	2.70	-62.85	-60.15	-41.20	-18.95
2440MHz	Pass	2.4835G	2.5035G	AV	2.4879G	2.70	-59.80	-57.10	-41.20	-15.90
2440MHz	Pass	2.5035G	2.6G	AV	2.536G	2.70	-59.85	-57.15	-41.20	-15.95
2440MHz	Pass	2.3G	2.38G	PK	2.34386G	2.70	-51.13	-48.43	-21.20	-27.23
2440MHz	Pass	2.38G	2.4G	PK	2.38996G	2.70	-51.86	-49.16	-21.20	-27.96
2440MHz	Pass	2.4G	2.4835G	PK	2.4835G	2.70	-52.97	-50.27	-21.20	-29.07
2440MHz	Pass	2.4835G	2.5035G	PK	2.4889G	2.70	-50.31	-47.61	-21.20	-26.41
2440MHz	Pass	2.5035G	2.6G	PK	2.53578G	2.70	-50.89	-48.19	-21.20	-26.99
2480MHz	Pass	2.3G	2.38G	AV	2.37456G	2.58	-64.39	-61.81	-41.20	-20.61



Mode	Result	F-Start (Hz)	F-Stop (Hz)	Type	Freq (Hz)	DG (dBi)	Psum (dBm)	EIRP (dBm)	Limit (dBm)	Margin (dB)
2480MHz	Pass	2.38G	2.4G	AV	2.38408G	2.58	-58.82	-56.24	-41.20	-15.04
2480MHz	Pass	2.4G	2.4835G	AV	2.4835G	2.58	-50.84	-48.26	-41.20	-7.06
2480MHz	Pass	2.4835G	2.5035G	AV	2.4835G	2.58	-51.44	-48.86	-41.20	-7.66
2480MHz	Pass	2.5035G	2.6G	AV	2.57629G	2.58	-59.99	-57.41	-41.20	-16.21
2480MHz	Pass	2.3G	2.38G	PK	2.37906G	2.58	-52.98	-50.40	-21.20	-29.20
2480MHz	Pass	2.38G	2.4G	PK	2.38416G	2.58	-51.01	-48.43	-21.20	-27.23
2480MHz	Pass	2.4G	2.4835G	PK	2.4835G	2.58	-42.05	-39.47	-21.20	-18.27
2480MHz	Pass	2.4835G	2.5035G	PK	2.4835G	2.58	-42.22	-39.64	-21.20	-18.44
2480MHz	Pass	2.5035G	2.6G	PK	2.52734G	2.58	-50.31	-47.73	-21.20	-26.53

DG = Directional Gain;  
 PX=Port X; Psum=P1+.P2+...PX

