

**FCC Part 15 Certification**  
**Test Report**

**2.4 GHz Frequency Hopping Spread Spectrum  
(Modular Approval)**

**FCC ID: HSW-BT2022M**  
**FCC Rule Part: 15.247**

**ACS Report Number: 03-0193-15BC**

Manufacturer: Cirronet, Inc.  
Model: BT2022

Test Begin Date: October 6, 2003  
Test End Date: October 24, 2003

Report Issue Date: January 5, 2004

Prepared by:   
R. Sam Wismer  
Engineering Manager  
ACS, Inc.

Reviewed by:   
Richard Bianco  
EMI/EMC Approvals Engineer  
ACS, Inc.

This test report shall not be reproduced except in full. This report may be reproduced in part with prior written consent of ACS, Inc. The results contained in this report are representative of the sample(s) submitted for evaluation.

**This report contains 16 pages**

# Table of Contents

---

<b>1.0 General</b>	<b>3</b>
1.1 Introduction	3
1.2 Product Description	3
1.2.1 General	3
1.2.2 Intended Use	3
1.2.3 Antennas	3
<b>2.0 Location of Test Facility</b>	<b>4</b>
2.1 Description of Test Facility	4
2.1.2 Open Area Test Site	5
2.1.2 Conducted Emissions Test Site	5
<b>3.0 Applicable Standards and References</b>	<b>6</b>
<b>4.0 List of Test Equipment</b>	<b>6</b>
<b>5.0 EUT Setup Block Diagram</b>	<b>7</b>
<b>6.0 Summary of Tests</b>	<b>8</b>
6.1 Section 15.203 - Antenna Requirement	8
6.2 Section 15.206 - Power Line Conducted Emissions	8
6.2.1 – Test Methodology	
6.2.2 – Test Results	
6.3 Section 15.209 - Radiated Emissions (Unintentional Radiation)	8
6.4 Section 15.247(b) – Peak Output Power	9
6.5 Section 15.247(a) – Channel Usage	10
6.5.1 Section 15.247(a)(1) - Adjacent Channel Spacing	10
6.5.2 Section 15.247(a)(1) – Number of Hopping Channels	10
6.5.3 Section 15.247(a)(1) – Channel Dwell Time	11
6.5.4 Section 15.247(a)(1)(i) – 20dB Bandwidth	13
6.6 Section 15.247(c) - Spurious Emissions	14
6.6.1 RF Conducted Spurious Emissions	14
6.6.1.1 Test Results	14
6.6.2 Radiated Spurious Emissions (Restricted Bands)	14
6.6.2.1 Duty Cycle Correction Factor	15
6.6.2.2 Test Results	15
6.6.2.3 Sample Calculations	15
<b>7.0 CONCLUSION</b>	<b>16</b>
<b><u>Additional Exhibits Included In Filing</u></b>	
<b>Data Plots A – Conducted Spurious Emissions</b>	<b>Schematics</b>
<b>Data Plots B – Radiated Spurious Emissions</b>	<b>Internal Photographs</b>
<b>Bill of Materials</b>	<b>External Photographs</b>
<b>Block Diagram</b>	<b>Test Setup Photographs</b>
<b>Theory of Operation</b>	<b>Product Labeling Info</b>
<b>Installation/Users Guide</b>	<b>RF Exposure – MPE Calculations</b>

## 1.0 GENERAL

### 1.1 Introduction

The purpose of this report is to demonstrate compliance with Part 15, Subpart C of the FCC's Code of Federal Regulations.

### 1.2 Product Description

Cirronet, Inc. supplied the following specification table for their product, the BT2022 module.

	Item	Specification
1	Supply voltage	VDD: 3.3 V +/- 0.1 V regulated voltage.
2	Carrier frequency	2400 MHz to 2483.5 MHz
3	Modulation method	GFSK, 1 Mbps, 0.5 BT Gaussian.
4	Maximum data rate	Asynchronous: 723.2 kbps / 57.6 kbps.
5	Transmission power	(Max +18) +16 to -12 dBm (Power control 6 stage).
6	Hopping	1600 hops/s, 1 MHz channel space.
7	Receiving signal range	-82 to -20 dBm.
8	Receiver IF frequency	1.5 MHz center frequency.
9	RF input impedance	50 Ohms.
10	Baseband crystal OSC	16 MHz.
11	Output interface	USB, PCM, SPI, UART.
12	Operation temperature	-20 to +70 °C.
13	Compliance	Bluetooth Specification Ver1.1.
15	Storage temperature	-40 to +80 °C.
16	USB specification	Ver 1.1.

#### 1.2.1 General

The EUT, is the Cirronet Inc. radio module model BT2022, is a frequency hopping spread spectrum radio module operating in the unlicensed band of 2402 – 2480 MHz designed for data transmissions.

Detailed photographs of the EUT are included separately with this filing.

#### 1.2.2 Intended Use

The EUT is intended to be offered to OEM manufacturers for integration into their final products. These products will be limited to mobile or fixed devices as defined by the FCC.

#### 1.2.3 Antennas

The Cirronet Inc. model BT2022 uses a Cirronet 2 dB gain patch antenna using a MMCX connector.

## 2.0 LOCATION OF TEST FACILITY

All testing was performed by qualified ACS personnel located at the following address:

ACS, Inc.  
5015 B.U. Bowman Drive  
Buford, GA 30518

## 2.1 DESCRIPTION OF TEST FACILITY

Both the Open Area Test Site (OATS) and Conducted Emissions site have been fully described, submitted to, and accepted by the FCC, Industry Canada and the Japanese Voluntary Control Council for Interference by information technology equipment.

The following certification numbers have been issued in recognition of these accreditations and certifications:

FCC Registration Number: 89450

Industry Canada Lab Code: IC 4175

VCCI Member Number: 1831

- VCCI OATS Registration Number R-1526
- VCCI Conducted Emissions Site Registration Number: C-1608

### 2.1.1 Open Area Test Site

The open area test site consists of a 40' x 66' concrete pad covered with a perforated electro-plated galvanized sheet metal. The perforations in the sheet metal are 1/8" holes that are staggered every 3/16". The individual sheets are placed to overlap each other by 1/4" and are riveted together to provide a continuous seam. Rivets are spaced every 3" in a 3 x 20 meter perimeter around the antenna mast and EUT area. Rivets in the remaining area are spaced as necessary to properly secure the ground plane and maintain the electrical continuity.

The entire ground plane extends 12' beyond the turntable edge and 16' beyond the antenna mast when set to a 10 meter measurement distance. The ground plane is grounded via 4 - 8' copper ground rods, each installed at a corner of the ground plane and bound to the ground plane using 3/4" stainless steel braided cable.

The turntable is an all aluminum 10' flush mounted table installed in an all aluminum frame. The table is remotely operated from inside the control room located 40' from the range. The turntable is electrically bonded to the surrounding ground plane via steel fingers installed on the edge of the turn table. The steel fingers make constant contact with the ground plane during operation.

Adjacent to the turntable is a 7' x 7' square and 4' deep concrete pit used for support equipment if necessary. The pit is equipped with 5 - 4" PVC chases from the pit to the control room that allow for cabling to the EUT if necessary. The underside of the turntable can be accessed from the pit so cables can be supplied to the EUT from the pit. The pit is covered with 2 sheets of 1/4" diamond style reinforced steel sheets. The sheets are painted to match the perforated steel ground plane, however the underside edges have been masked off to maintain the electrical continuity of the ground plane. All reflecting objects are located outside of the ellipse defined in ANSI C63.4.

A diagram of the Open Area Test Site is shown in Figure 3.2-1 below:

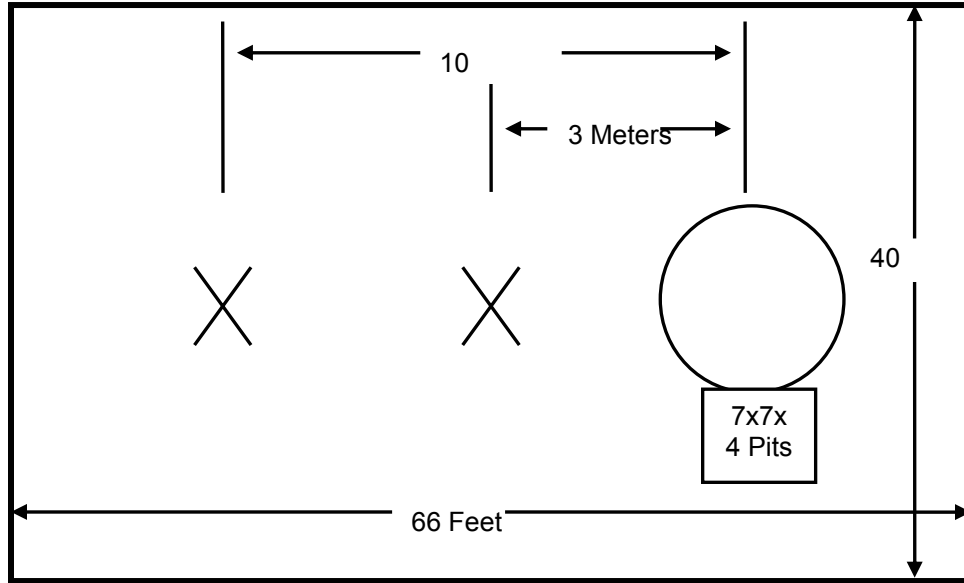

Figure 3.2-1: Open Area Test Site

**2.1.2 Conducted Emissions Test Site Description**

The AC mains conducted EMI site is a shielded room with the following dimensions:

- Height: 3.0 Meters
- Width: 3.6 Meters
- Length: 4.9 Meters

The room is manufactured by Rayproof Corporation and installed by Panashield, Inc. Earth ground is provided to the room via an 8' copper ground rod. Each panel of the room is connected electrically at intervals of 4".

Power to the room is filtered to prevent ambient noise from coupling to the EUT and measurement equipment. Filters are models 1B42-60P manufactured by Rayproof Corporation.

The room is of sufficient size to test table top and floor standing equipment in accordance with section 6.1.4 of ANSI C63.4.

A diagram of the room is shown below in figure 2.1.2-1:

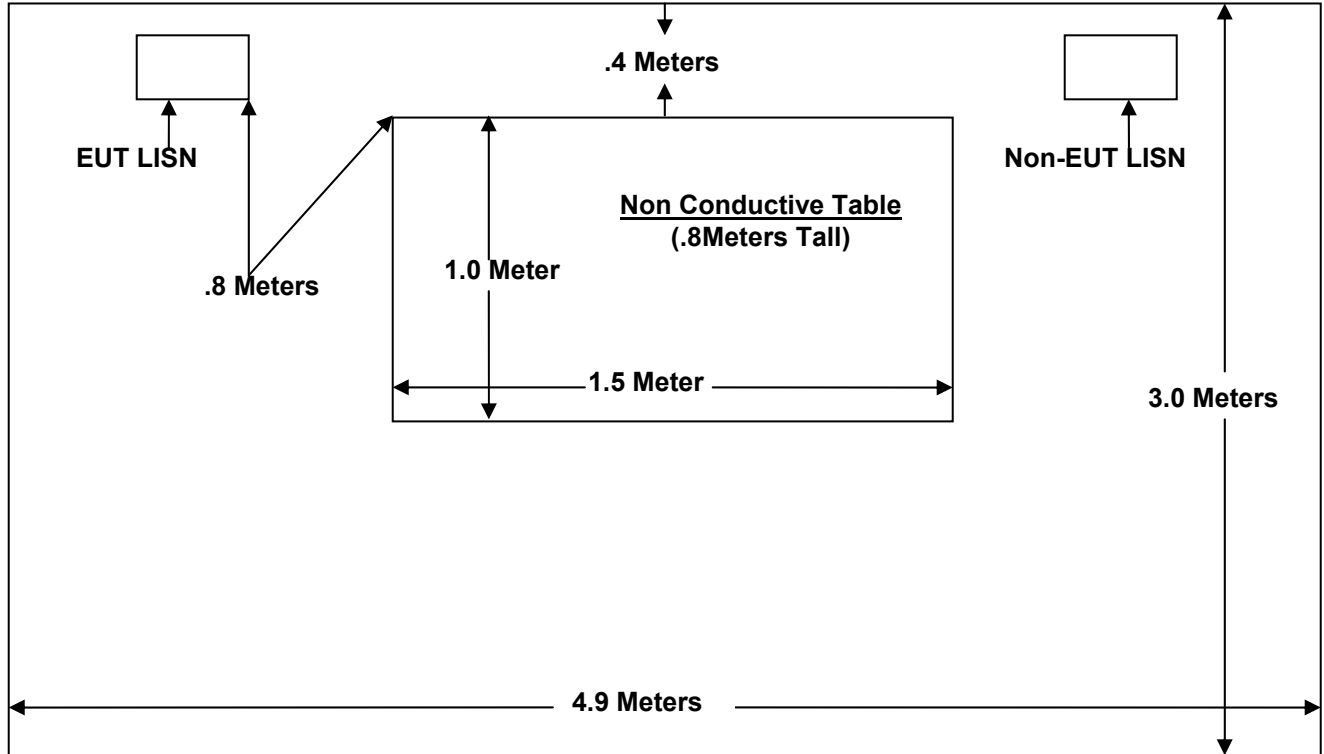

Figure 3.3-1: AC Mains Conducted EMI Site

**3.0 APPLICABLE STANDARD REFERENCES**

The following standards were used:

- 1 - ANSI C63.4-1992: Method of Measurements of Radio-Noise Emissions from Low-Voltage Electrical and Electronic Equipment in the 9KHz to 40GHz
- 2 - US Code of Federal Regulations (CFR): Title 47, Part 15, Subpart C: Radio Frequency Devices, Intentional Radiators (October 2000)
- 3 - FCC OET Bulletin 65 Appendix C - Evaluating Compliance with FCC Guidelines for Human Exposure to Radiofrequency Electromagnetic Fields

**4.0 LIST OF TEST EQUIPMENT**

All test equipment used for regulatory testing is calibrated yearly or according to manufacturer's specifications.

**Table 4-1: Test Equipment**

Equipment Calibration Information					
ACS #	Mfg.	Eq. type	Model	S/N	Cal. Due
2	Rohde & Schwarz	Spectrum Analyzer	ESMI	839587/003	12/23/03
1	Rohde & Schwarz	Display Unit	ESDI	839379/011	12/26/03
26	Chase	Bi-Log Antenna	CBL6111	1044	10/14/04
152	EMCO	LISN	3825/2	9111-1905	12/11/03
153	EMCO	LISN	3825/2	9411-2268	12/11/03
16	ACS	Cable	RG8	16	4/14/04
23	ACS	Cable	RG8	23	1/3/04
24	ACS	Cable	Heliax	24	04/07/04
5	ACS	Cable	LL-335	None	8/20/04
6	ACS	Cable	LL-335	None	8/6/04
22	Agilent	Pre-Amplifier	8449B	3008A0052 6	9/18/04
73	Agilent	Pre-Amplifier	8447D	272A05624	04/15/04
30	Spectrum Technologies	Horn Antenna	DRH-0118	970102	5/8/04
105	Microwave Circuits	High Pass Filter	H1G810G1	2123-01 DC0225	6/17/04
40	EMCO	Biconical Antenna	3104	3211	9/19/04

**5.0 EQUIPMENT UNDER TEST SETUP BLOCK DIAGRAM**

**Table 5-1: Equipment List**

Diagram Number	Manufacturer	Equipment Type	Model Number	Serial Number	FCC ID
1	Cirronet	Radio Module	BT2022	627-400	HSW-BT2022
2	Cirronet	Ethernet Adapter	n/a	n/a	n/a
3	Volgen	Power Adapter	SPU10R-2	n/a	n/a
4	IBM	Laptop	760ELD	78-TFN16	ANOGCF2704AT
5	IBM	Power Adapter	12J1445	n/a	n/a

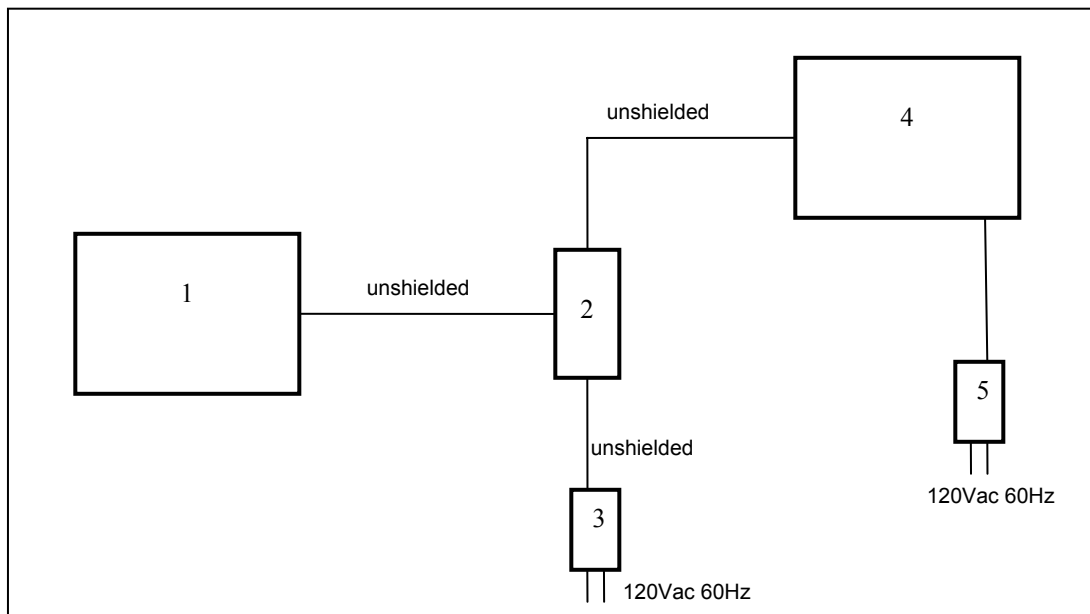

**Figure 5-2: EUT Test Setup**

**6.0 SUMMARY OF TESTS**

Along with the tabular data shown below, plots were taken of all signals deemed important enough to document.

**6.1 Antenna Requirement - FCC Section 15.203**

The EUT employs an MMCX connector. According to FCC Public Notice, DA 00-2225, the MMCX qualifies as a unique antenna coupler.

**6.2 Power Line Conducted Emissions - FCC Section 15.207**

**6.2.1 Test Methodology**

ANSI C63.4 sections 6 and 7 were the guiding documents for this evaluation. Conducted emissions were performed from 150 kHz to 30MHz with the spectrum analyzer’s resolution bandwidth set to 9 kHz and the video bandwidth set to 30 kHz.

**6.2.2 Test Results**

The EUT will be provided DC power by the host device in which it is installed. With no connection to the AC mains this requirement is not applicable to the EUT.

**6.3 Radiated Emissions - FCC Section 15.209(Unintentional Radiation)**

Radiated emissions tests were performed over the frequency range of 30MHz to 25GHz, 10 times the highest fundamental frequency. Measurements of the radiated field strength were made at a distance of 3m from the boundary of the equipment under test (EUT) and the receiving antenna. The antenna height was varied from 1m to 4m so that the maximum radiated emissions level would be detected. Radiated measurements were made with the Spectrum Analyzer’s resolution bandwidth set to 120 kHz for measurements above 30MHz.

The EUT was caused to go into a “Receive Only” mode of operation for this test. Results of the test are given in Table 6.3-1 below:

**Table 6.3-1: Radiated Emissions Tabulated Data**

Frequency (MHz)	Uncorrected Reading (dBµV)	Antenna Polarity (H/V)	Antenna Height (cm)	Turntable Position (°)	Total Correction Factor (dB)	Corrected Reading (dBµV)	Limit (dBµV)	Margin (dB)	Results
36.56	13.8	V	100	1	16.58	30.38	40	9.6	Pass
45.12	14.5	V	100	0	12.54	27.04	40	13.0	Pass
121.6	14	H	100	0	12.86	26.86	43.5	16.6	Pass
127.68	14	H	100	1	13.00	27.00	43.5	16.5	Pass
192.31	22	H	100	270	10.80	32.80	43.5	10.7	Pass
199.92	17.7	H	100	0	10.90	28.60	43.5	14.9	Pass
701.619	38.2	H	100	315	-1.44	36.76	46	9.2	Pass
701.619	37.6	V	125	131	-1.44	36.16	46	9.8	Pass



**6.4 Peak Output Power Requirement - FCC Section 15.247(b)**

The peak output power of the EUT was made at the antenna connector using a Rhode & Schwarz ESMI Spectrum Analyzer. For the measurement, the EUT was caused to generate a constant carrier. Results are shown below in Table 6.4-1 and a plot of the worst case is shown in Figure 6.4-1.

**Table 6.4-1: Peak Output Power**

Channel	Frequency (MHz)	Output Power (dBm)
Low	2402	15.43
Center	2441	15.59
High	2480	15.31

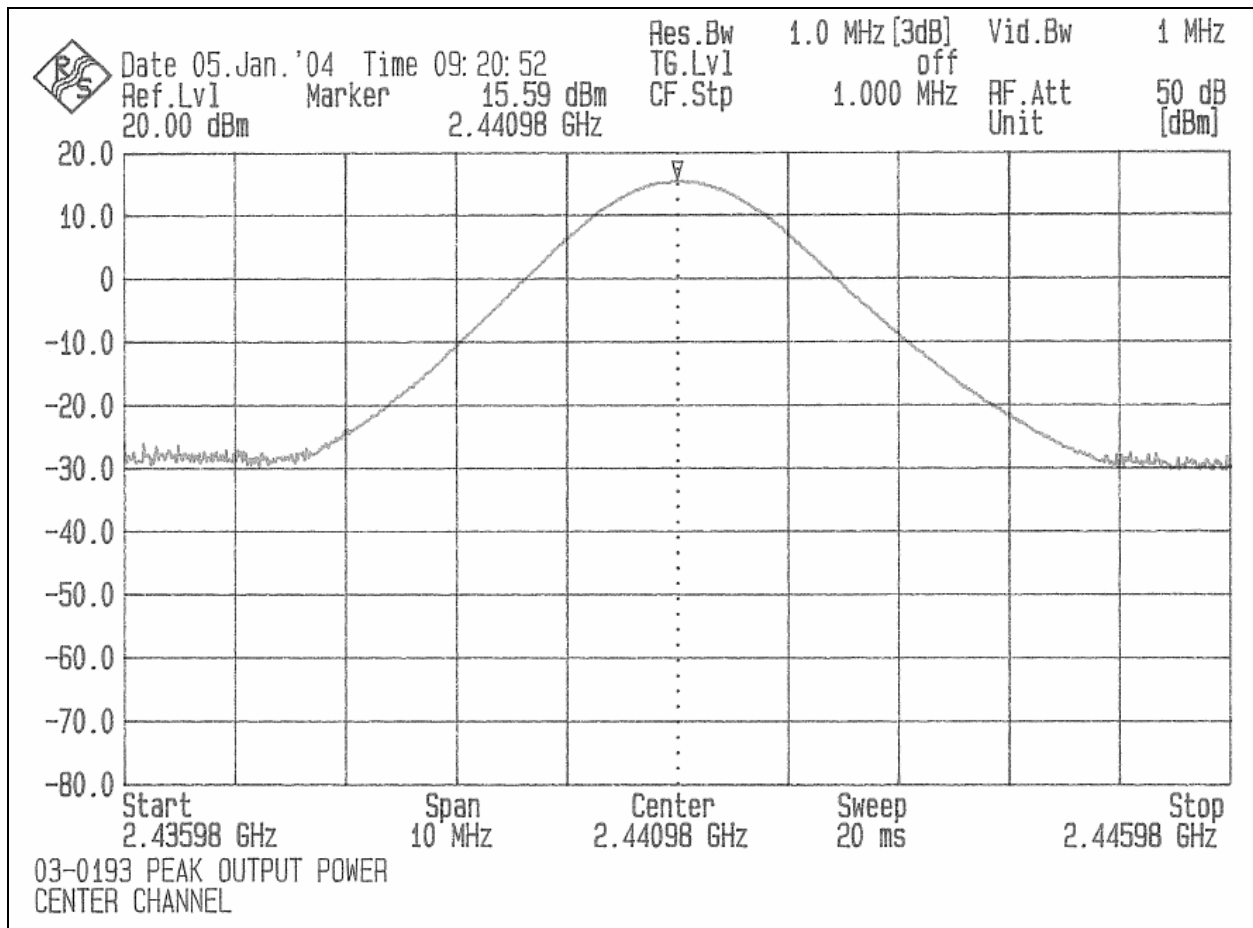

**Figure 6.4-1: Output power**

**6.5 Channel Usage Requirements - FCC Section 15.247(a)**

**15.247(a) (1):** Frequency hopping systems shall have hopping channel carrier frequencies separated by a minimum of 25 kHz or the 20 dB bandwidth of the hopping channel, whichever is greater. The system shall hop to channel frequencies that are selected at the system hopping rate from a pseudo randomly ordered list of hopping frequencies. Each frequency must be used equally on the average by each transmitter. The system receivers shall have input bandwidths that match the hopping channel bandwidths of their corresponding transmitters and shall shift frequencies in synchronization with the wanted signal.

**15.247(a) (1) (ii):** Frequency hopping systems operating in the 2400–2483.5 MHz and 5725–5850 MHz bands shall use at least 75 hopping frequencies. The maximum 20dB bandwidth of the hopping channel is 1 MHz. The average time of occupancy on any frequency shall not be greater than 0.4 seconds within a 30 second period.

**6.5.1 Adjacent Channel Separation**

**Results:** The adjacent channel separation was measured to be 1.00 MHz for all channels. A plot of the High channel is shown below in figure 6.5.1-1

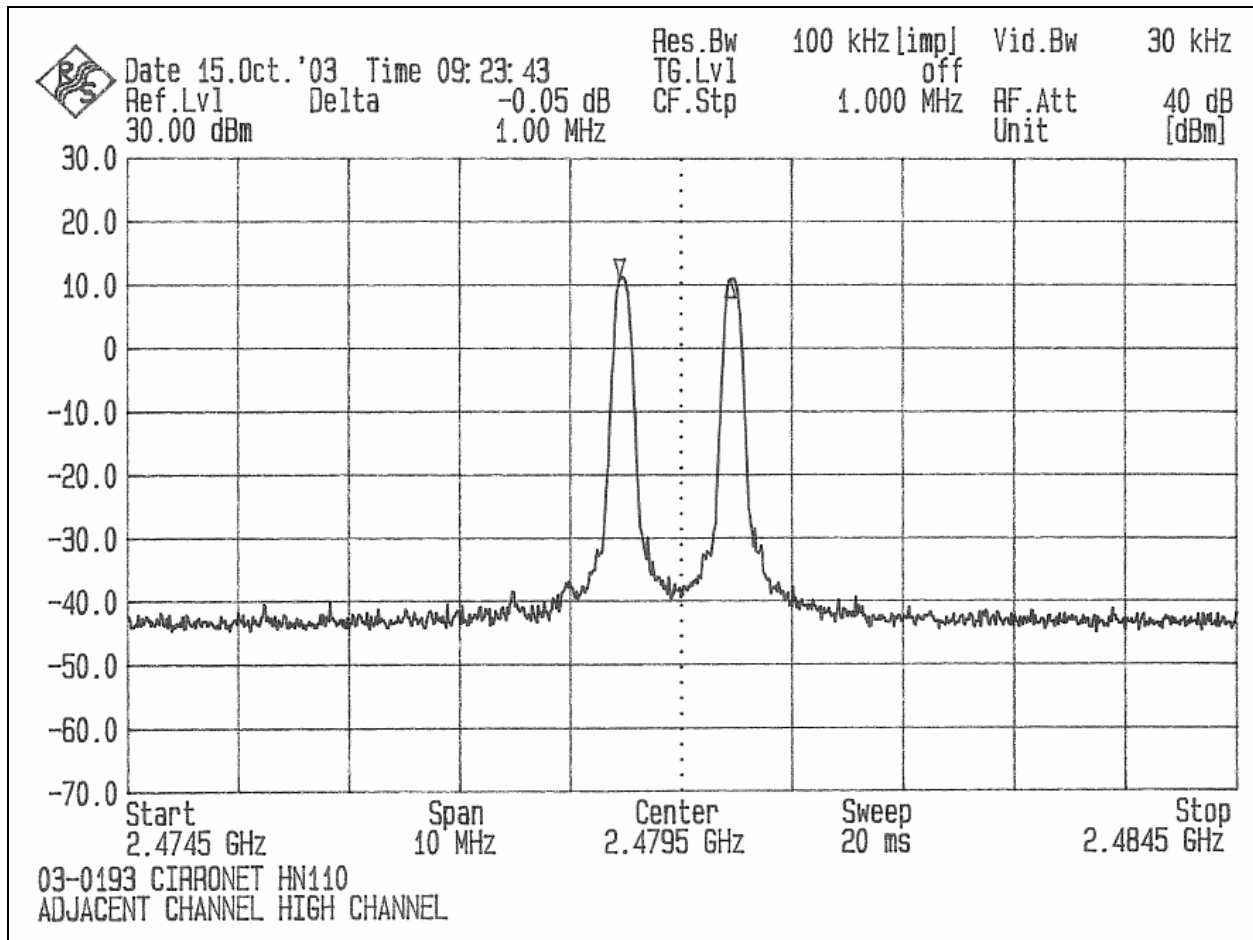

**Figure 6.5.1-1: Adjacent Channel Separation**

### 6.5.2 Number of Hopping Channels

**Result:** The 20dB bandwidth of the device is less than 250 kHz. The device employs more than 50 hopping channels as required. Results are shown in figure 6.5.2-1 below.

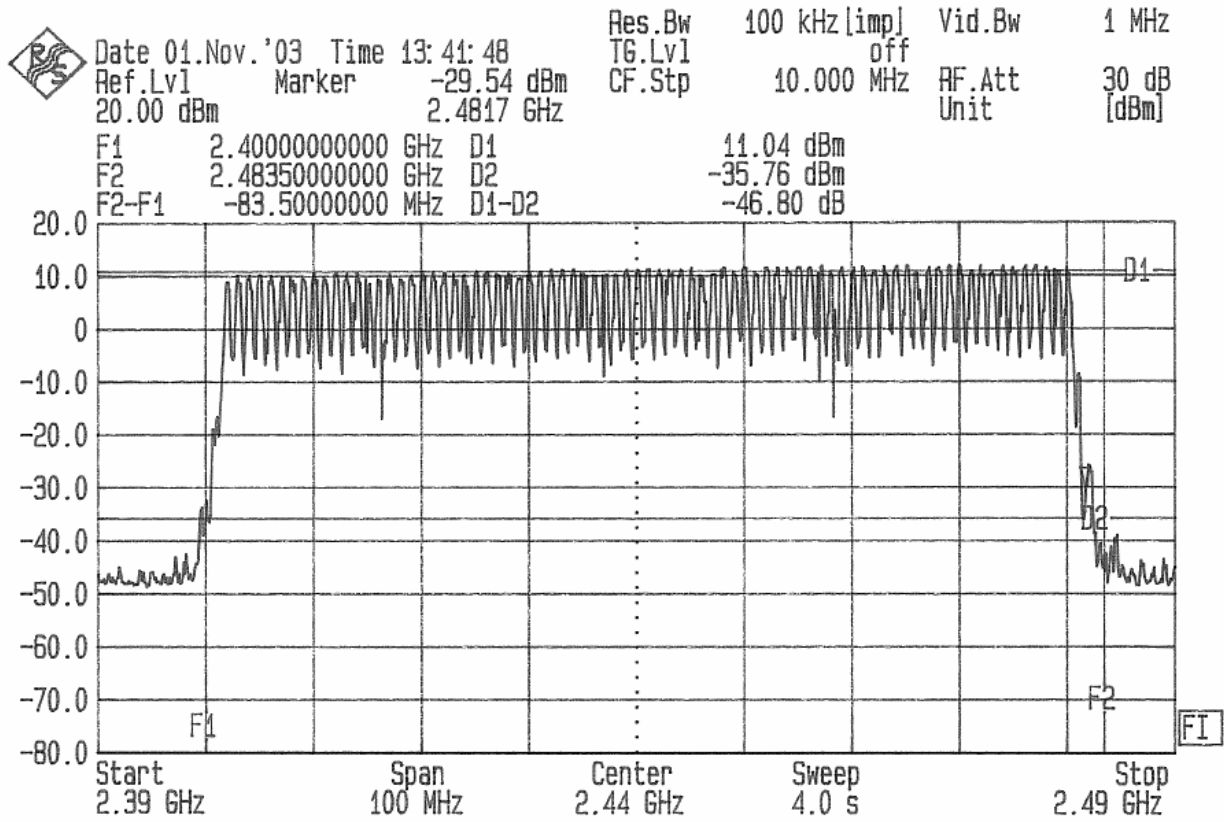

03-0193

Figure 6.5.2-1: Number of Hopping Channels

**6.5.3 Channel Dwell Time**

**Result:** For average measurements, the measured level was reduced by a factor 27dB to account for the duty cycle of the EUT. The EUT transmits three 625uS every 100mS. The period of a single burst is 46.9mS. Therefore the duty cycle is calculated by  $(3 \times 625\text{ms}) / 46.9\text{ms} = 3.99\%$ . The duty cycle correction factor is determined using the formula:  $20 \cdot \log(.0399) = -27\text{dB}$ . See figure 6.5.3-1 and appendix I for further details.

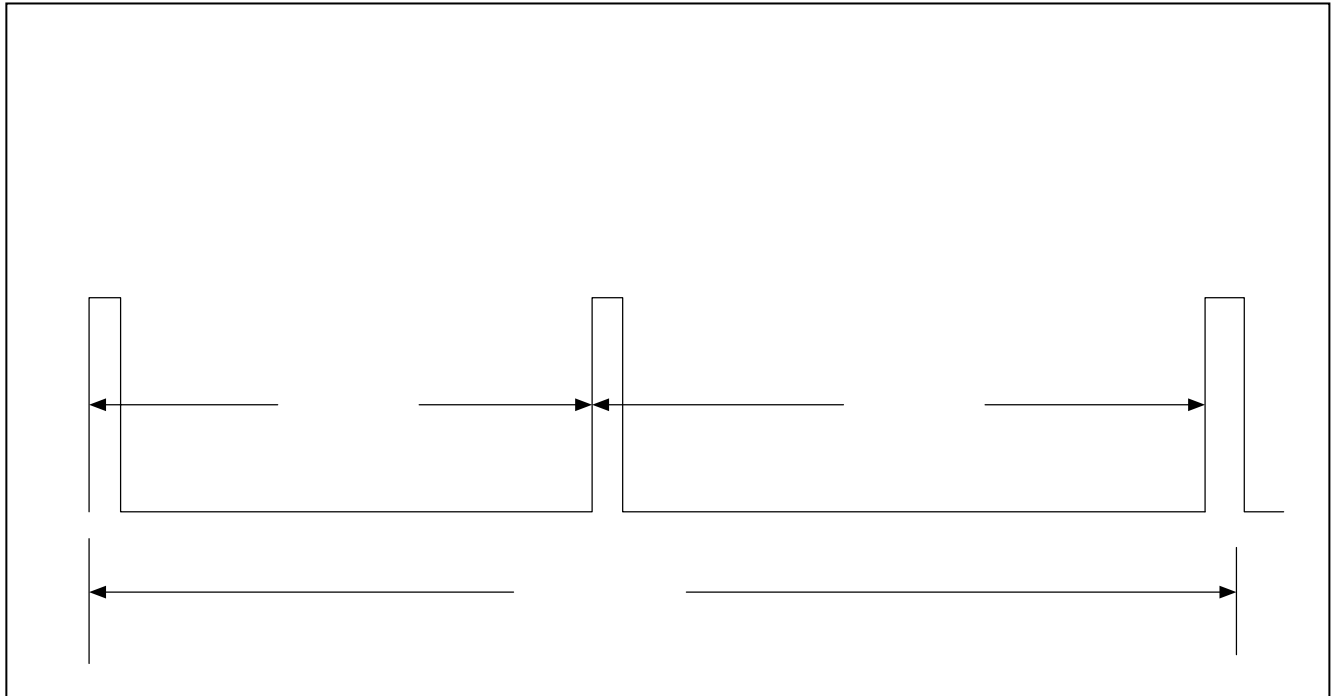

**Figure 6.5.3-1: Channel Dwell Time**

**6.5.4 20dB Bandwidth**

**Result:** The 20dB bandwidth was found to be less than 1 MHz across all channels as required. Results are shown below in Table 6.5.4-1 and a plot of the channel with the greatest bandwidth is shown in Figure 6.5.4-1.

**Table 6.5.4-1: 20dB Bandwidth**

Channel	Frequency (MHz)	20dB Bandwidth (kHz)
Low	2402	187.50
Center	2441	192.36
High	2480	188.19

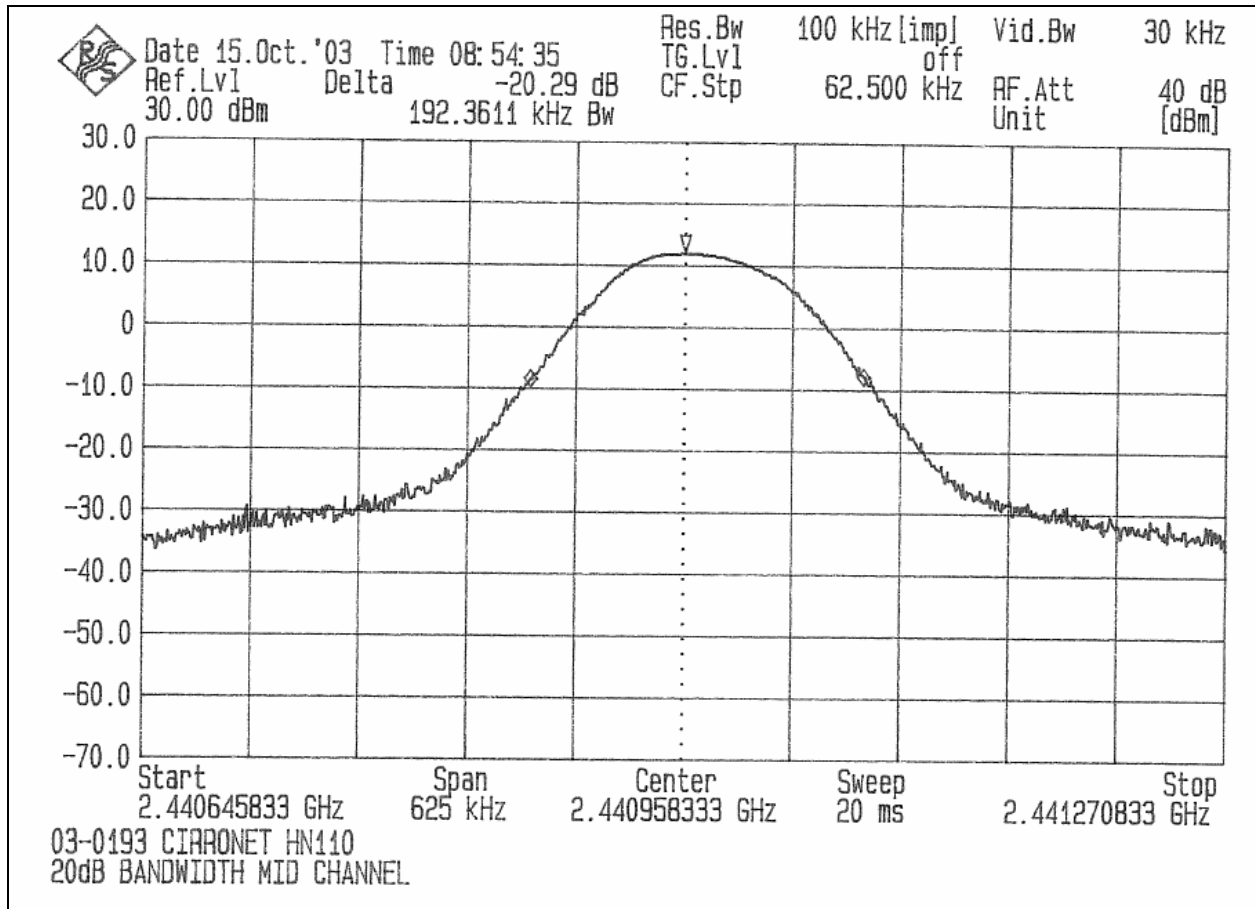

Figure 6.5.4-1: 20dB Bandwidth

**6.6 Spurious Emissions - FCC Section 15.247(c)**

**6.6.1 RF Conducted Spurious Emissions**

The EUT was investigated for conducted spurious emissions from 30MHz to 25GHz, 10 times the highest fundamental frequency. For each measurement, the spectrum analyzer’s VBW was set to 100kHz and the RBW was set to 1MHz.

**6.6.1.2 Test Results**

**Result:** All emission found were greater than 20dB down from the fundamental carrier. The RF conducted spurious emissions found in the band of 30MHz to 25GHz are reported in Table 6.6.1.2 below. Plots were taken also and are filed separately with this filing in a file titled “03-0193 Data Plots A.doc”. Each emission was compared to the fundamental reference level to determine if they were at least 20dB below the reference level.

**Table 6.6.1.2: RF Conducted Spurious Emissions**

Frequency (MHz)	Level (dBm)	Peak Power (dBm)	Limit (dBm)	Margin (dB)	Final Result (Pass/Fail)
<b>High Channel:</b>					
1012.8	-53.85	15.31	-4.69	-49.16	Pass
4960.3	-32.34			-27.65	Pass
9922.2	-43.39			-38.7	Pass
12400	-57.63			-52.94	Pass
15000	-76.27			-71.58	Pass
20000	-79.17			-74.48	Pass
<b>Mid Channel:</b>					
952.1	-60.68	15.59	-4.41	-56.27	Pass
4882.2	-31.02			-26.61	Pass
9766.6	-49.13			-44.72	Pass
12205.5	-59.36			-54.95	Pass
15000	-76.12			-71.71	Pass
20000	-80.67			-76.26	Pass
<b>Low Channel:</b>					
895.8	-55.02	15.43	-4.57	-50.45	Pass
4805.6	-32.04			-27.47	Pass
9611.1	-56.54			-51.97	Pass
12011.1	-64.82			-60.25	Pass
15000	-76.81			-72.24	Pass
20000	-78.53			-73.96	Pass

**6.6.2 Radiated Spurious Emissions (Restricted Bands) - FCC Section 15.205**

Radiated emissions tests were made over the frequency range of 30MHz to 25GHz, 10 times the highest fundamental frequency on each antenna given in section 1.2.3.

The EUT was rotated through 360° and the receive antenna height was varied from 1m to 4m so that the maximum radiated emissions level would be detected. For frequencies below 1000MHz, quasi-peak measurements were made using a resolution bandwidth (RBW) of 120 kHz and a video bandwidth (VBW) of 300 kHz. For frequencies above 1000MHz, average measurements were made using an RBW of 1MHz and a VBW of 10Hz and peak measurements were made with RBW of 1MHz and a VBW of 1MHz.

The EUT was caused to generate a carrier signal on the hopping channel.

### 6.6.2.1 Duty Cycle Correction

For average measurements, the measured level was reduced by a factor 27dB to account for the duty cycle of the EUT. The EUT transmits three 625uS every 100mS. The period of a single burst is 46.9mS. Therefore the duty cycle is calculated by  $(3 \times 625\text{ms}) / 46.9\text{ms} = 3.99\%$ . The duty cycle correction factor is determined using the formula:  $20 \cdot \log(.0399) = -27\text{dB}$ . See figure 6.5.3-1 and appendix I for further details.

### 6.6.2.2 Test Results

Radiated spurious emissions found in the band of 30MHz to 25GHz are reported in Table 6.6.2.2-1. Plots of these emissions are also presented separately in file "03-0193 Data Plots B.pdf" of this filing. Each emission found to be in a restricted band as defined by section 15.205, was compared to the radiated emission limits for a class B device defined in section 15.209.

**Table 6.6.2.2-1: Radiated Spurious Emissions**

Frequency (MHz)	Level (dBuV/m)	Detector (P/A)	Correction Factors (dB)	Corrected Level (dBuV/m)	Limit (dBuV/)	Margin (dB)	Final Result (Pass/Fail)
<b>High Channel</b>							
4559	65.83	P	6.50	72.33	74.00	1.67	<b>PASS</b>
4559	65.88	A	-20.50	45.38	54.00	8.62	<b>PASS</b>
7437	56.69	P	12.89	69.58	74.00	4.42	<b>PASS</b>
7437	56.18	A	-14.11	42.07	54.00	11.93	<b>PASS</b>
9917	47.07	P	15.15	62.22	74.00	11.78	<b>PASS</b>
9917	45.75	A	-11.85	33.90	54.00	20.10	<b>PASS</b>
12400	36.71	P	23.00	59.71	74.00	14.29	<b>PASS</b>
12400	36.71	A	-4.00	32.71	54.00	21.29	<b>PASS</b>
<b>Mid Channel</b>							
4881	62.34	p	8.03	70.37	74.00	3.63	<b>PASS</b>
4881	62.04	a	-18.97	43.07	54.00	10.93	<b>PASS</b>
7322	56.96	p	13.19	70.15	74.00	3.85	<b>PASS</b>
7322	56.31	a	-13.81	42.50	54.00	11.50	<b>PASS</b>
9763	50.55	p	14.71	65.26	74.00	8.74	<b>PASS</b>
9763	48.55	a	-12.29	36.26	54.00	17.74	<b>PASS</b>
<b>Low Channel</b>							
4804	64.19	p	7.66	71.85	74.00	2.15	<b>PASS</b>
4804	63.88	a	-19.34	44.54	54.00	9.46	<b>PASS</b>
7205	52.46	p	13.50	65.96	74.00	8.04	<b>PASS</b>
7205	52.05	a	-13.50	38.55	54.00	15.45	<b>PASS</b>
9607	54.08	p	14.27	68.35	74.00	5.65	<b>PASS</b>
4804	64.19	p	7.66	71.85	74.00	2.15	<b>PASS</b>

**6.6.2.3 Sample Calculation:**

$$R_C = R_U + CF_T$$

Where:

$CF_T$	=	Total Correction Factor (AF+CA+AG)-DC(Average Measurements Only)
$R_U$	=	Uncorrected Reading
$R_C$	=	Corrected Level
AF	=	Antenna Factor
CA	=	Cable Attenuation
AG	=	Amplifier Gain
DC	=	Duty Cycle Correction Factor

**Example Calculation:**

Corrected Level: 61.97 dBuV/m + 8.40 dB = 70.37 dBuV

Margin: 74 dBuV – 70.37dBuV = 3.63 dB

**7.0 Conclusion**

In the opinion of ACS, Inc. the BT2022 spread spectrum radio module, manufactured by Cirronet, Inc., meets the requirements of FCC Part 15 subpart C.



**Part 15 Certification**  
**Test Report**

**2.4 GHz Frequency Hopping Spread Spectrum  
(Modular Approval)**

**FCC ID: HSW-BT2022M**

**FCC Rule Part: 15.247**

**ACS Report Number: 03-0193-15BC**

Manufacturer: Cirronet, Inc.  
Model: BT2022

**Data Plots A**

## **Data Plots**

**ACS Report Number: 03-0193-15B**

Manufacturer: Cirronet, Inc.  
Model: BT2022

**Test: Conducted Spurious Emissions**  
**Channel: Low**



Date 08.Oct.'03 Time 14:45:25 MSG  
 Ref.Lvl -10.00 dBm Marker -55.02 dBm 895.8 MHz  
 Res.BW 100 kHz [imp] Vid.BW 1 MHz  
 TG.Lvl Off  
 CF.Stp 242.000 MHz  
 RF.Att Unit 10 dB [dBm]

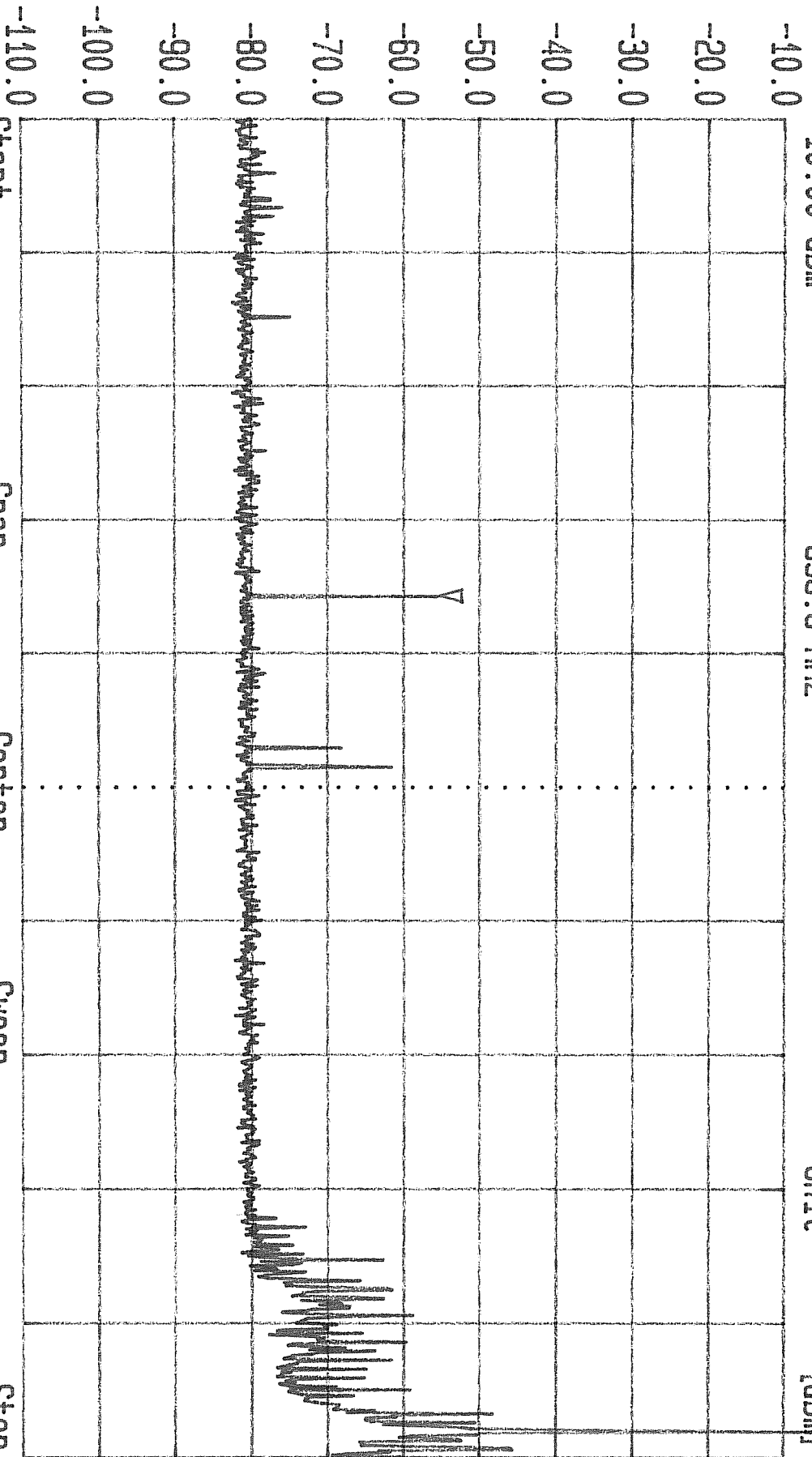

Start 0.030 GHz Span 2.42 GHz Center 1.24 GHz Sweep 1.54 s Stop 2.45 GHz  
 03-0193 CIRRONET HN110  
 LOW CHANNEL



Date 08.Oct.'03 Time 14:49:16 MSG  
 Ref.Lvl -10.00 dBm Marker -32.04 dBm  
 Res.BW 100 KHz Imp1  
 CF.Stp 265.000 MHz Off  
 Vid.BW 1 MHz  
 RF.Att Unit 10 dB [dBm]

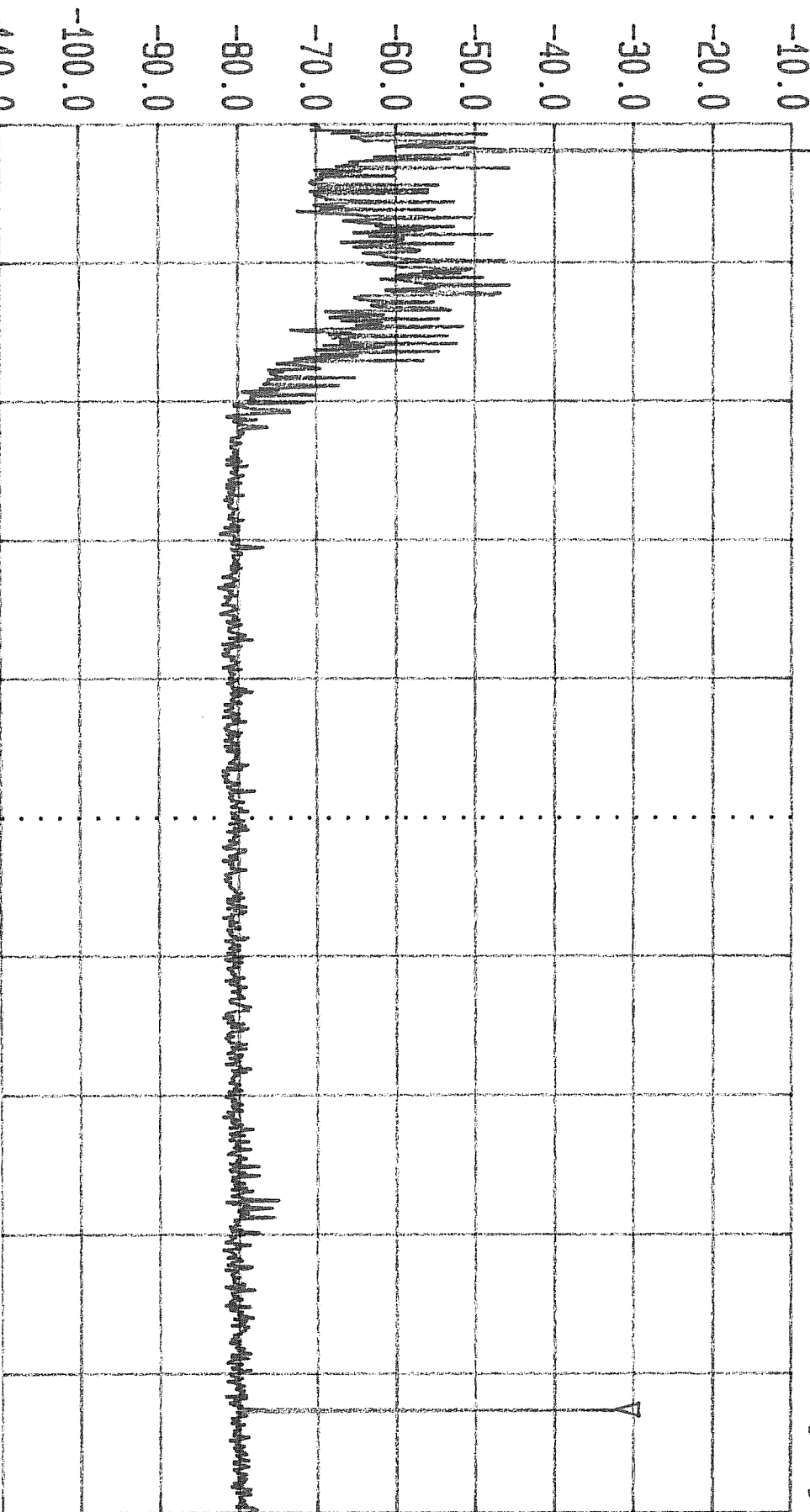

Start 2.35 GHz Span 2.65 GHz Center 3.675 GHz Sweep 1.68 s Stop 5 GHz  
 03-0193 CIRRONET HN110  
 LOW CHANNEL



Date 08.Oct.'03 Time 14:53:12  
 Ref.Lvl1 -10.00 dBm  
 Marker -56.54 dBm  
 9.6111 GHz

Res.BW 100 KHz [imp]  
 TG.Lvl1 Off  
 CF.Stp 500.000 MHz  
 Vid.BW 1 MHz  
 RF.Att Unit 10 dB [dBm]

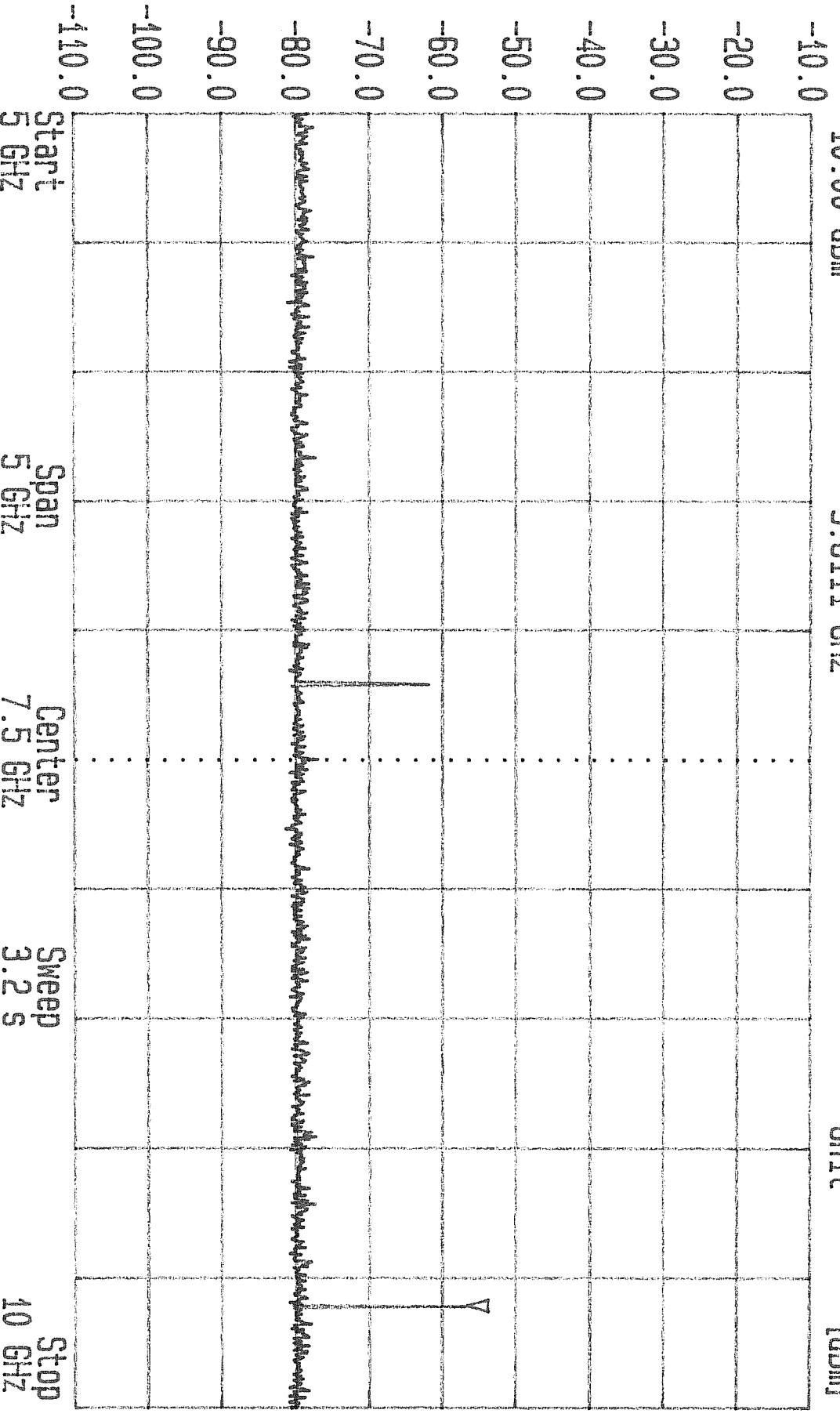

03-0193 CIRRONET HN110  
 LOW CHANNEL



Date 08.Oct.'03 Time 14:56:43  
 Ref.Lvl1 -10.00 dBm  
 Marker -64.82 dBm  
 12.0111 GHz

Res.Bw 100 kHz [imp] 1 MHz  
 TG.Lvl1 off  
 CF.Stp 500.000 MHz  
 Vid.Bw 10 dB [dBm]  
 RF.Att Unit

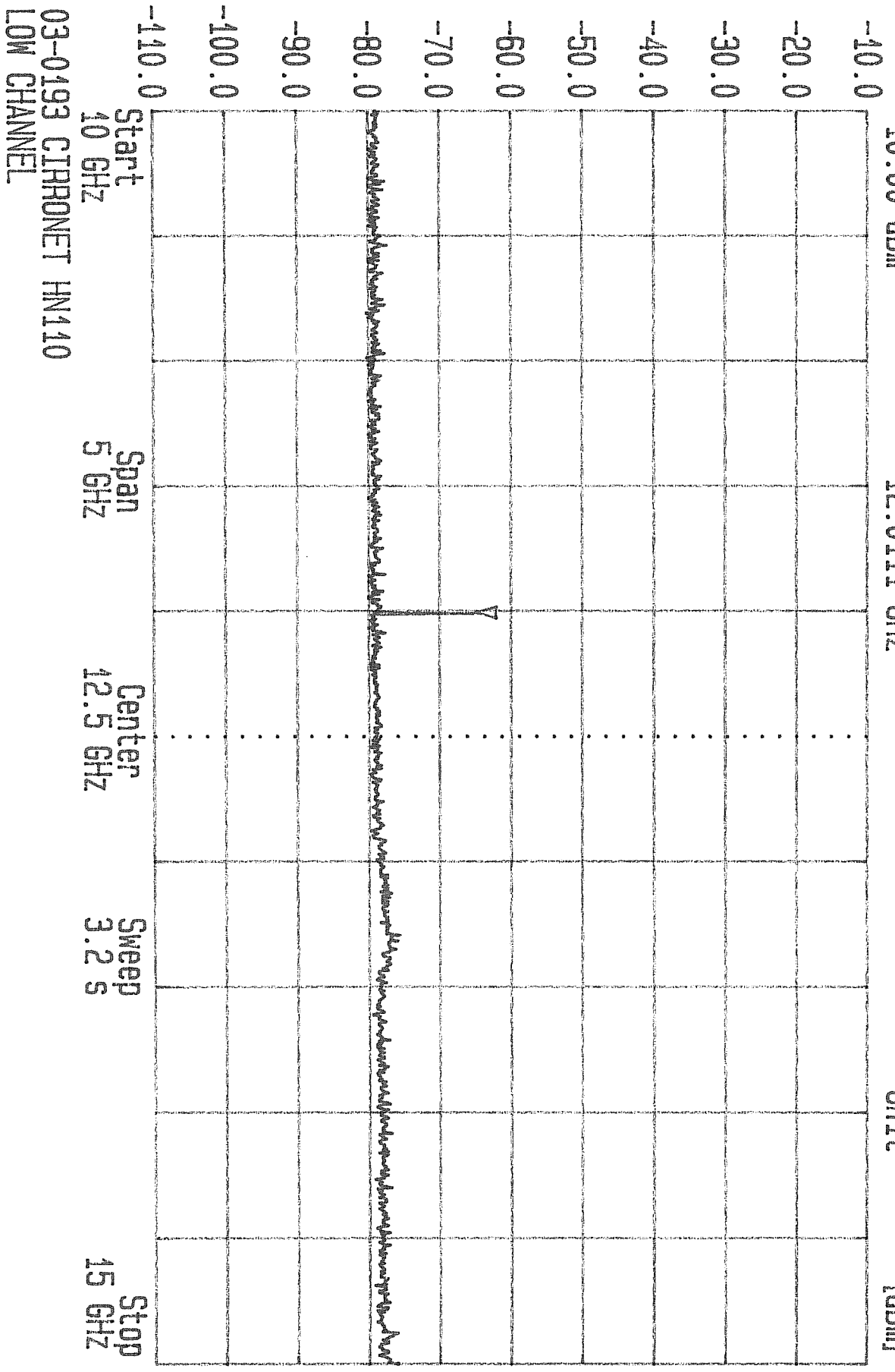

Start 40 GHz  
 Span 5 GHz  
 Center 12.5 GHz  
 Sweep 3.2 s  
 Stop 15 GHz

03-0193 CIRRONET HN110  
 LOW CHANNEL



Date 08.Oct.'03 Time 15:01:38  
 Ref.Lvl1 -10.00 dBm  
 Marker -76.81 dBm  
 15.0000 GHz

Res.BW 100 kHz [imp]  
 TG.Lvl1 Off  
 CF.Stp 500.000 MHz  
 Vid.BW 1 MHz  
 AF.Att Unit [dBm]

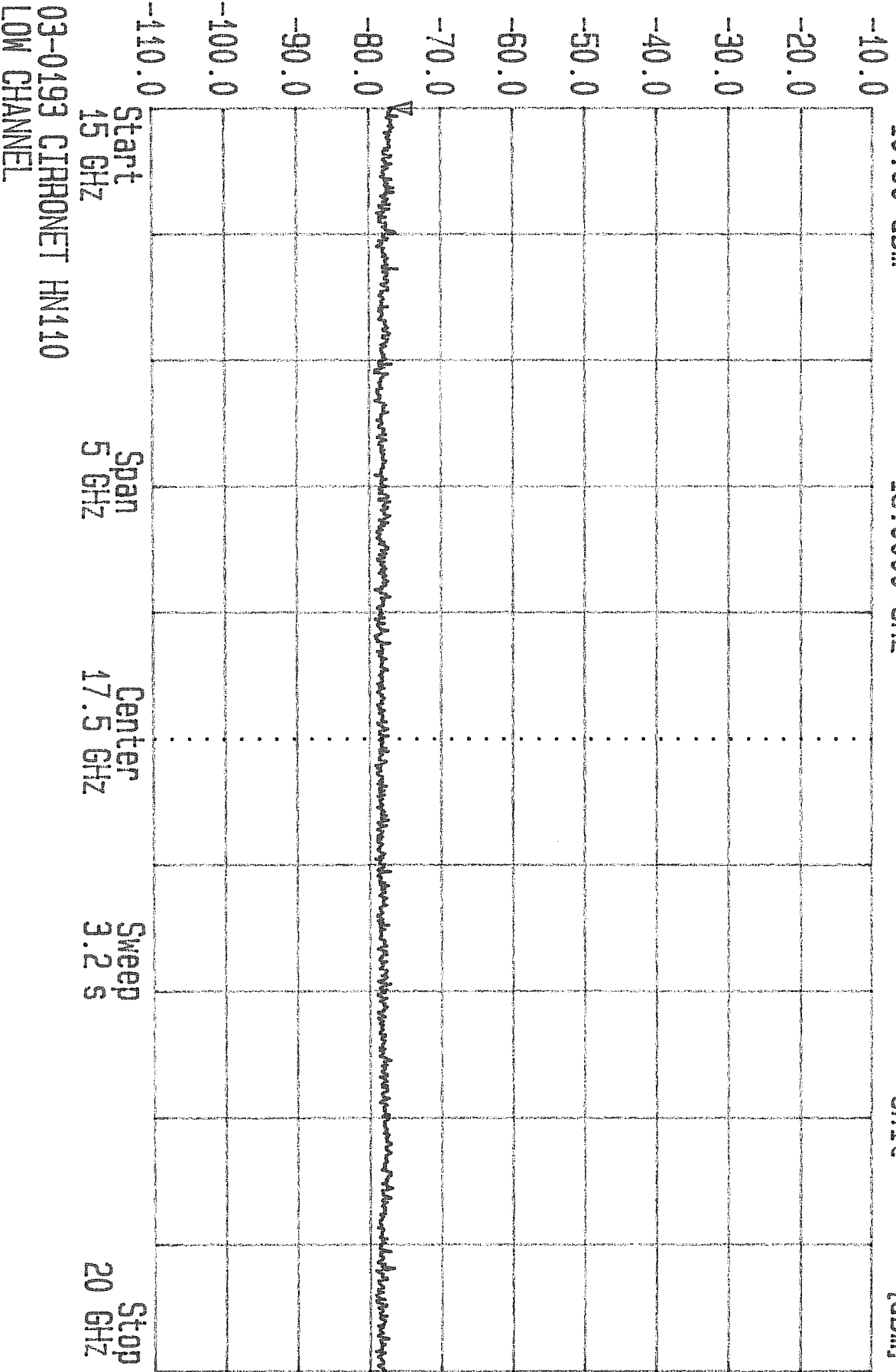



Date 08.Oct.'03 Time 15:05:08  
 Ref.Lvl -10.00 dBm Marker -78.53 dBm  
 20.0000 GHz

Res.BW 100 kHz [imp]  
 TG.Lvl 16.Lvl off  
 CF.Stp 500.000 MHz  
 Vid.BW 1 MHz  
 AF.Att Unit 10 dB [dBm]

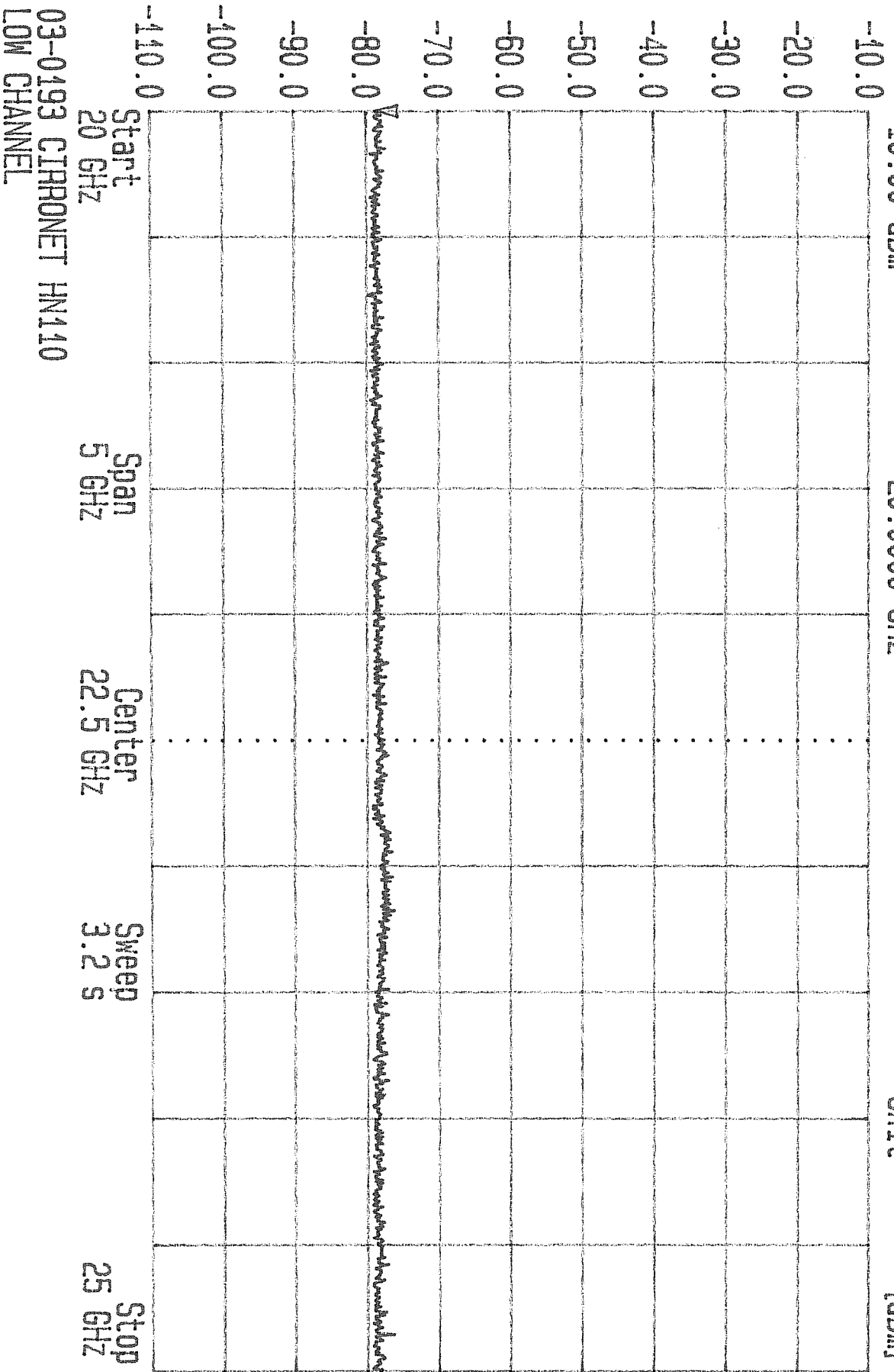



## **Data Plots**

**ACS Report Number: 03-0193-15B**

Manufacturer: Cirronet, Inc.  
Model: BT2022

**Test: Conducted Spurious Emissions**  
**Channel: Center**



Date 08.Oct.'03 Time 15:13:07 MSG  
Ref.Lvl -10.00 dBm Marker -60.68 dBm Res.BW 100 kHz [imp] 1 MHz  
952.1 MHz CF.Stp 247.000 MHz Off Vid.BW 10 dB  
AF.Att Unit [dBm]

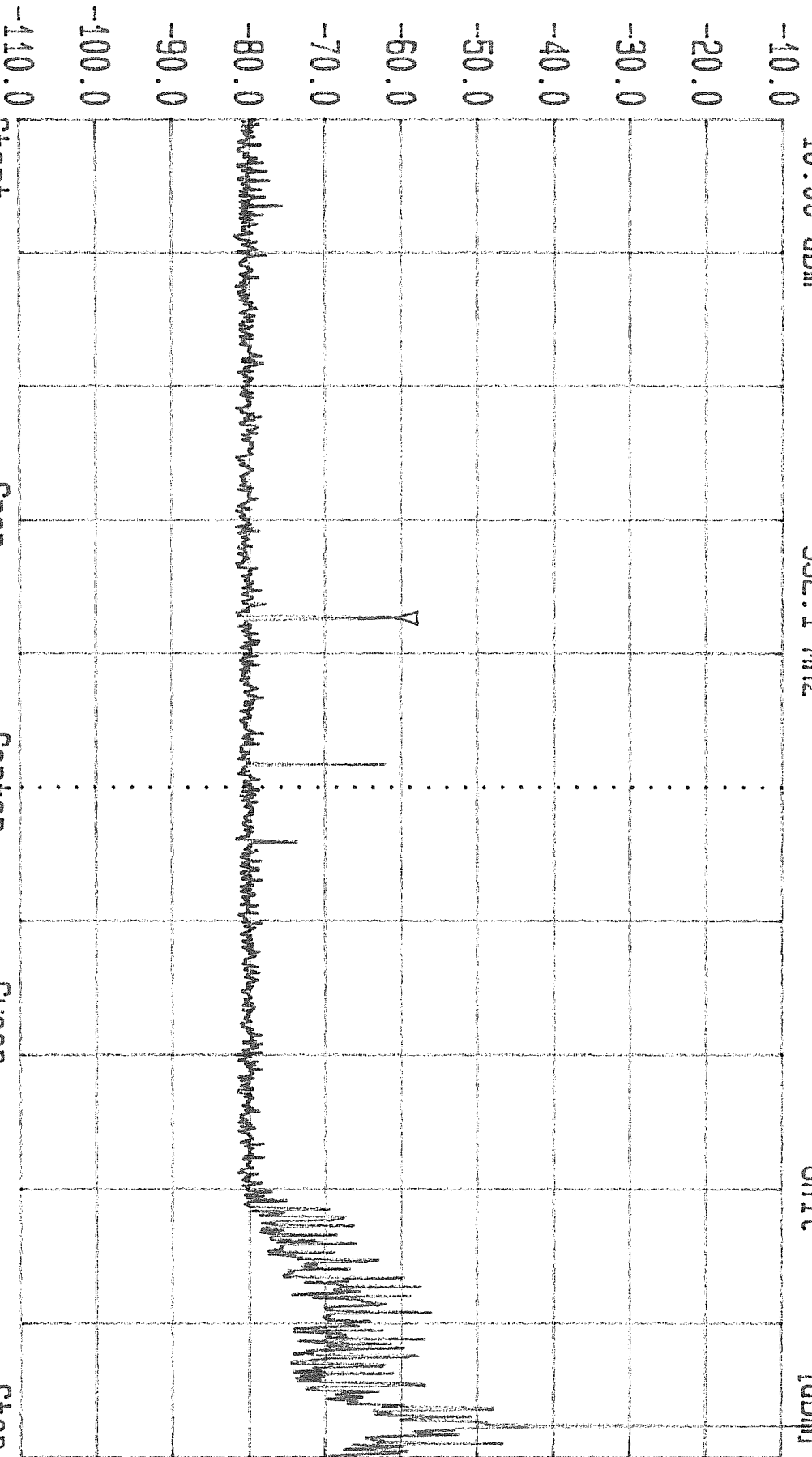

Start 0.030 GHz Span 2.47 GHz Center 1.265 GHz Sweep 1.56 s Stop 2.5 GHz  
03-0193 CIRRONET HN110  
MID CHANNEL



Date 08.Oct.'03 Time 15:20:49 MSG  
 Ref.Lvl -10.00 dBm Marker -31.02 dBm  
 4.8822 GHz Res.BW 100 kHz [imp] Vid.BW 1 MHz  
 TG.Lvl CF.Stp 265.000 MHz Off RF.Att 10 dB  
 Unit [dBm]

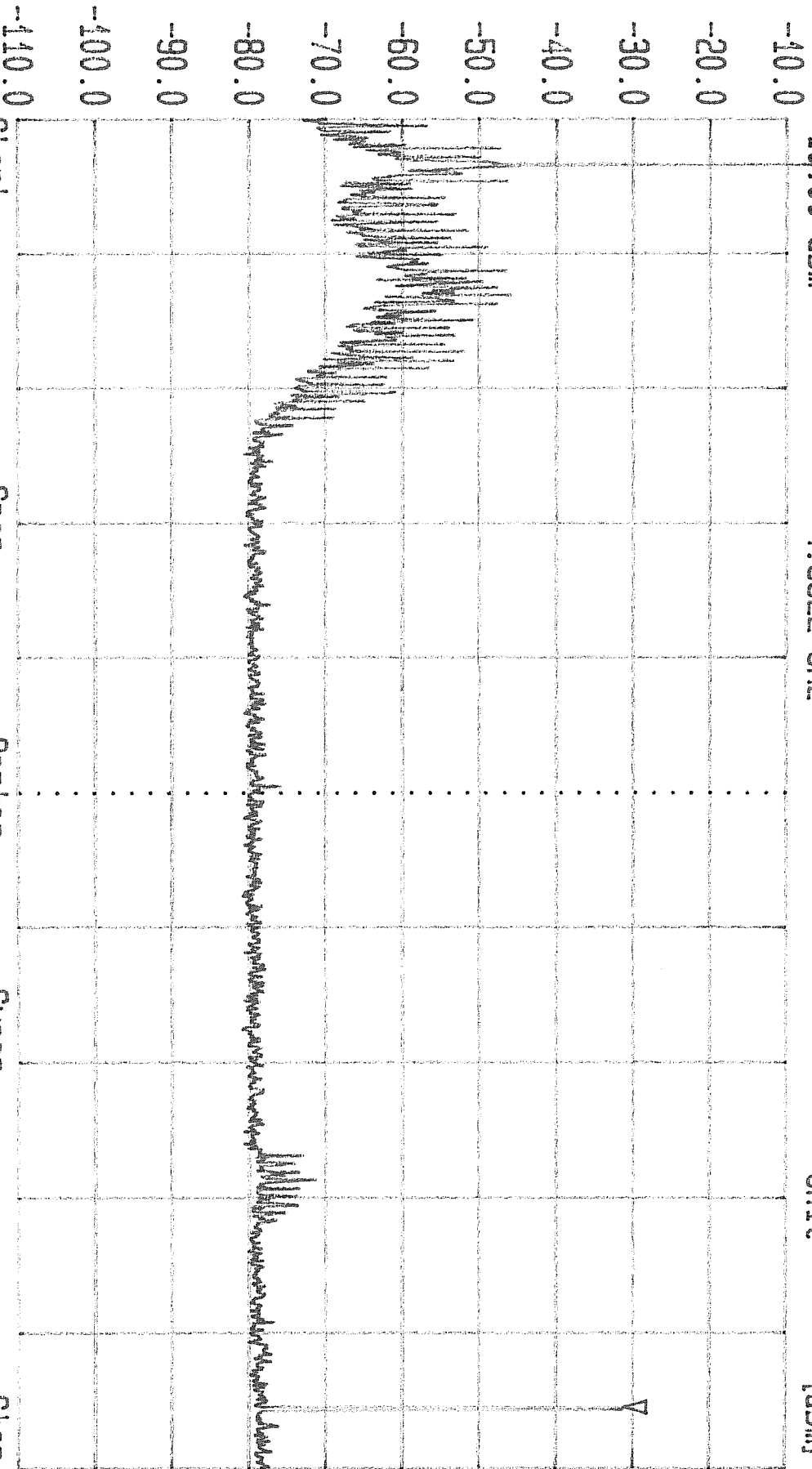

Start 2.35 GHz Span 2.65 GHz Center 3.675 GHz Sweep 1.68 S Stop 5 GHz  
 03-0193 CIPRONET HN110  
 MID CHANNEL



Date 08.Oct.'03 Time 15:25:07

Ref.Lvl -10.00 dBm Marker -49.13 dBm 9.7666 GHz

Res.Bw 100 KHz [imp] Vid.Bw 1 MHz  
TG.Lvl off  
CF.Stp 500.000 MHz  
RF.Att Unit  
[dBm]

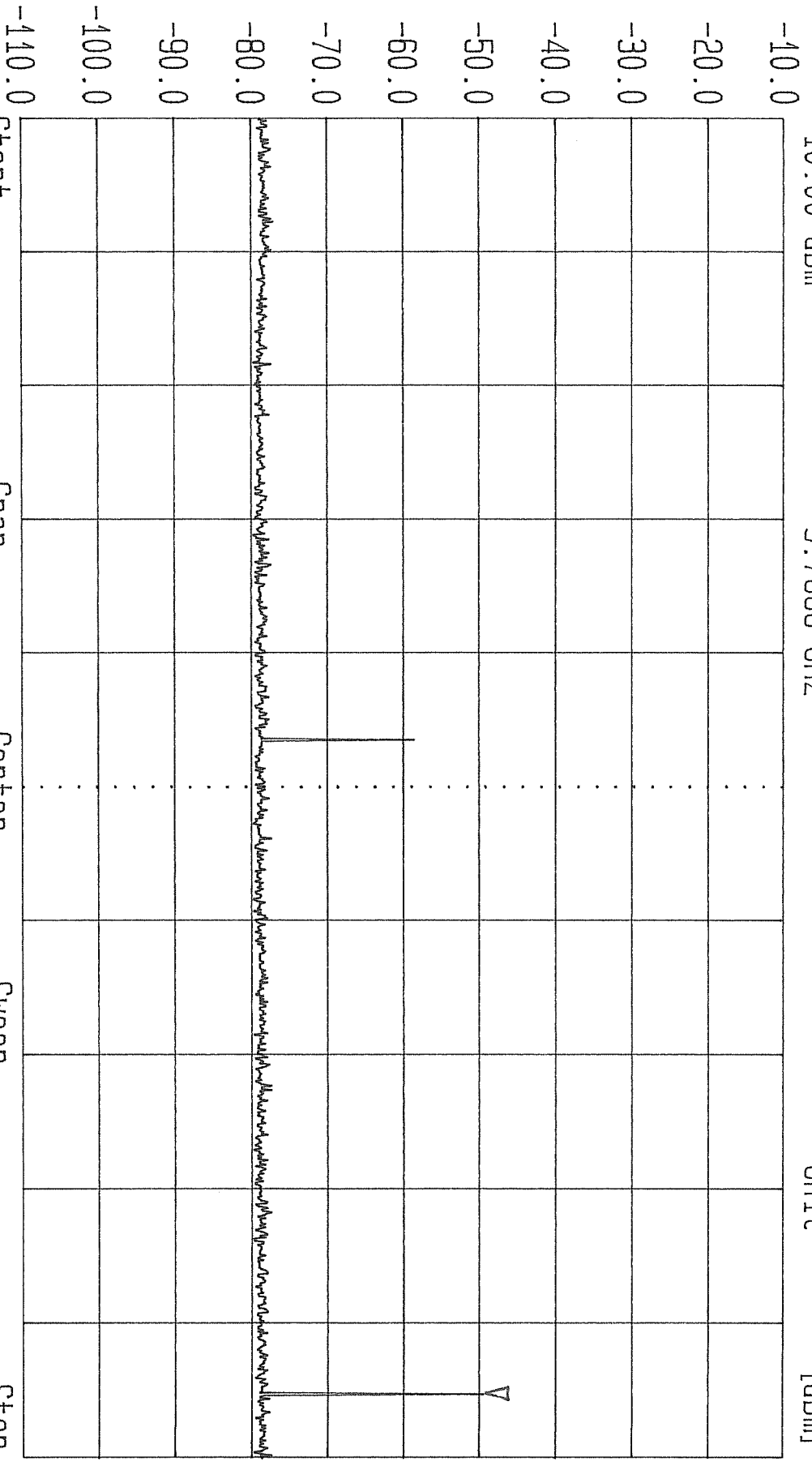

Start 5 GHz Span 5 GHz Center 7.5 GHz Sweep 3.2 s Stop 10 GHz

03-0193 CIRRONET HN110  
MID CHANNEL



Date 08.Oct.'03 Time 15:33:26  
 Ref.Lvl1 -10.00 dBm Marker -59.36 dBm  
 12.2055 GHz

Res.BW 100 KHz [imp] Vid.BW 1 MHz  
 TG.Lvl1 off  
 CF.Stp 500.000 MHz  
 RF.Att Unit 10 dB [dBm]

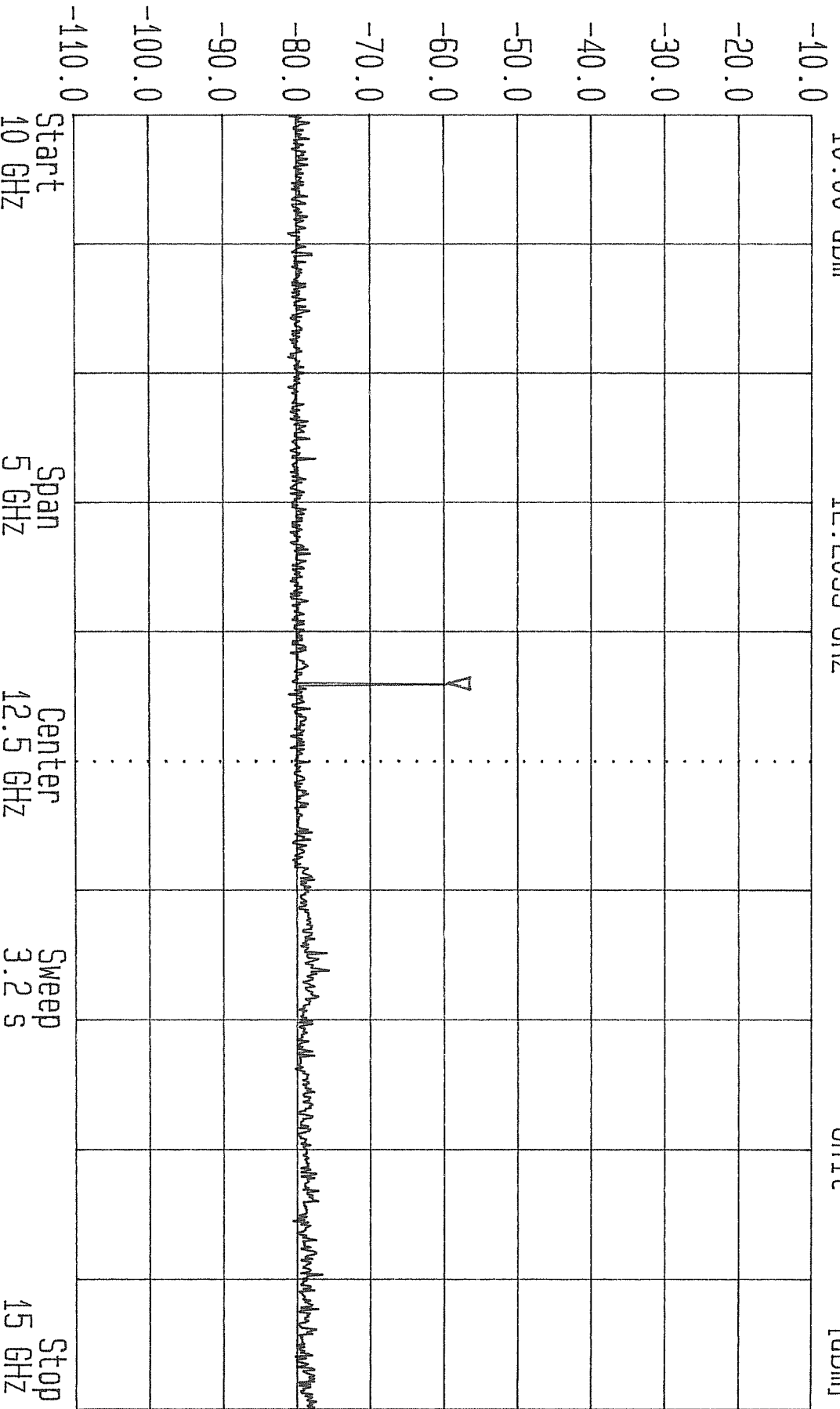

03-0193 CIRRONET HN110  
 MID CHANNEL



Date 08.Oct.'03 Time 15:41:56  
 Ref.Lvl -10.00 dBm Marker -76.12 dBm  
 15.0000 GHz

Res.Bw 100 KHz [imp]  
 TG.Lvl off  
 CF.Stp 500.000 MHz  
 Vid.Bw 1 MHz  
 RF.Att Unit  
 [dBm]

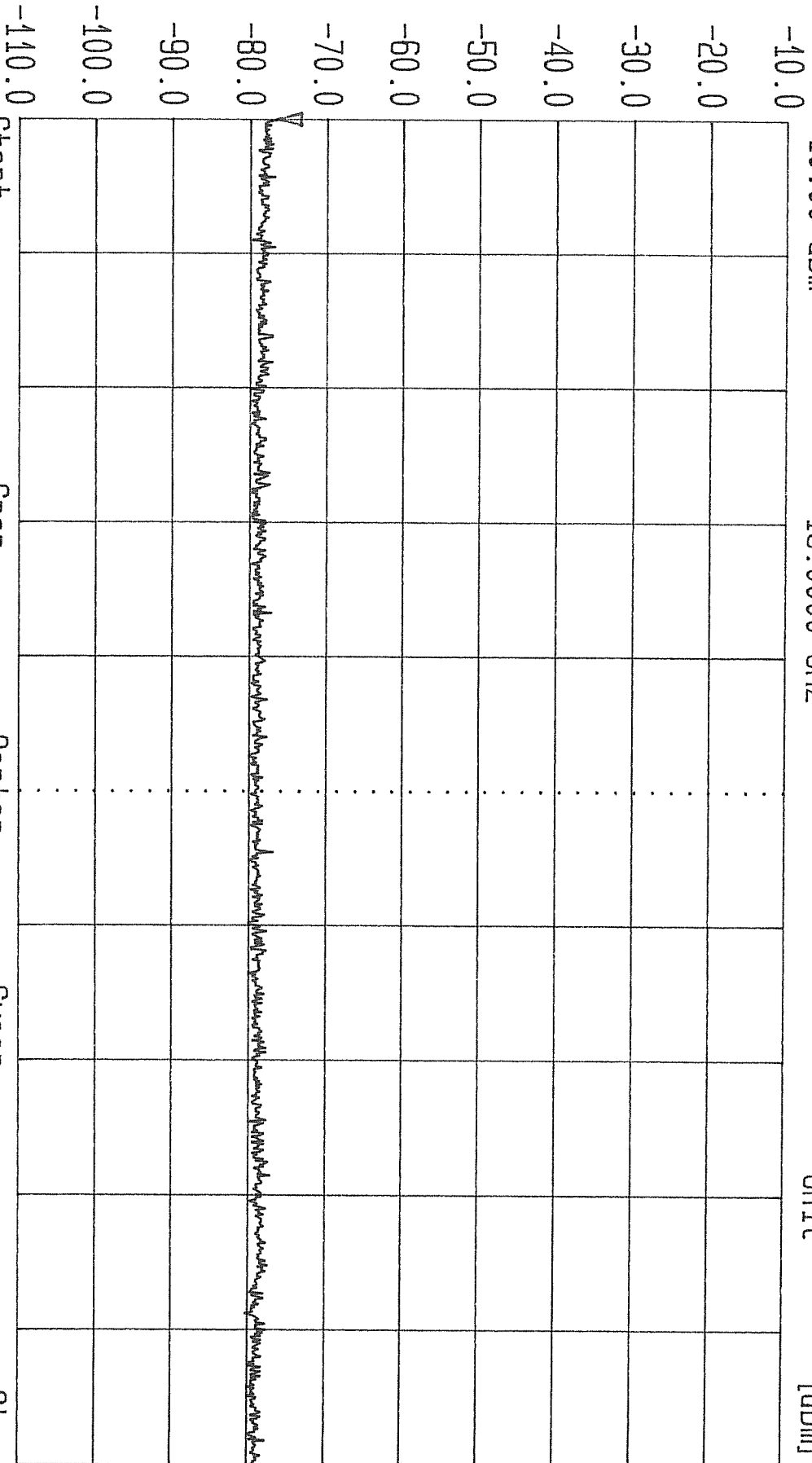

Start 15 GHz  
 Span 5 GHz  
 Center 17.5 GHz  
 Sweep 3.2 s  
 Stop 20 GHz  
 03-0193 CIRRONET HN110  
 MID CHANNEL



Date 08.Oct.'03 Time 15:47:20  
 Ref.Lvl -10.00 dBm Marker -80.67 dBm  
 20.0000 GHz

Res.Bw 100 kHz [imp]  
 TG.Lvl off  
 CF.Stp 500.000 MHz  
 Vid.Bw 1 MHz  
 RF.Att Unit  
 10 dB [dBm]

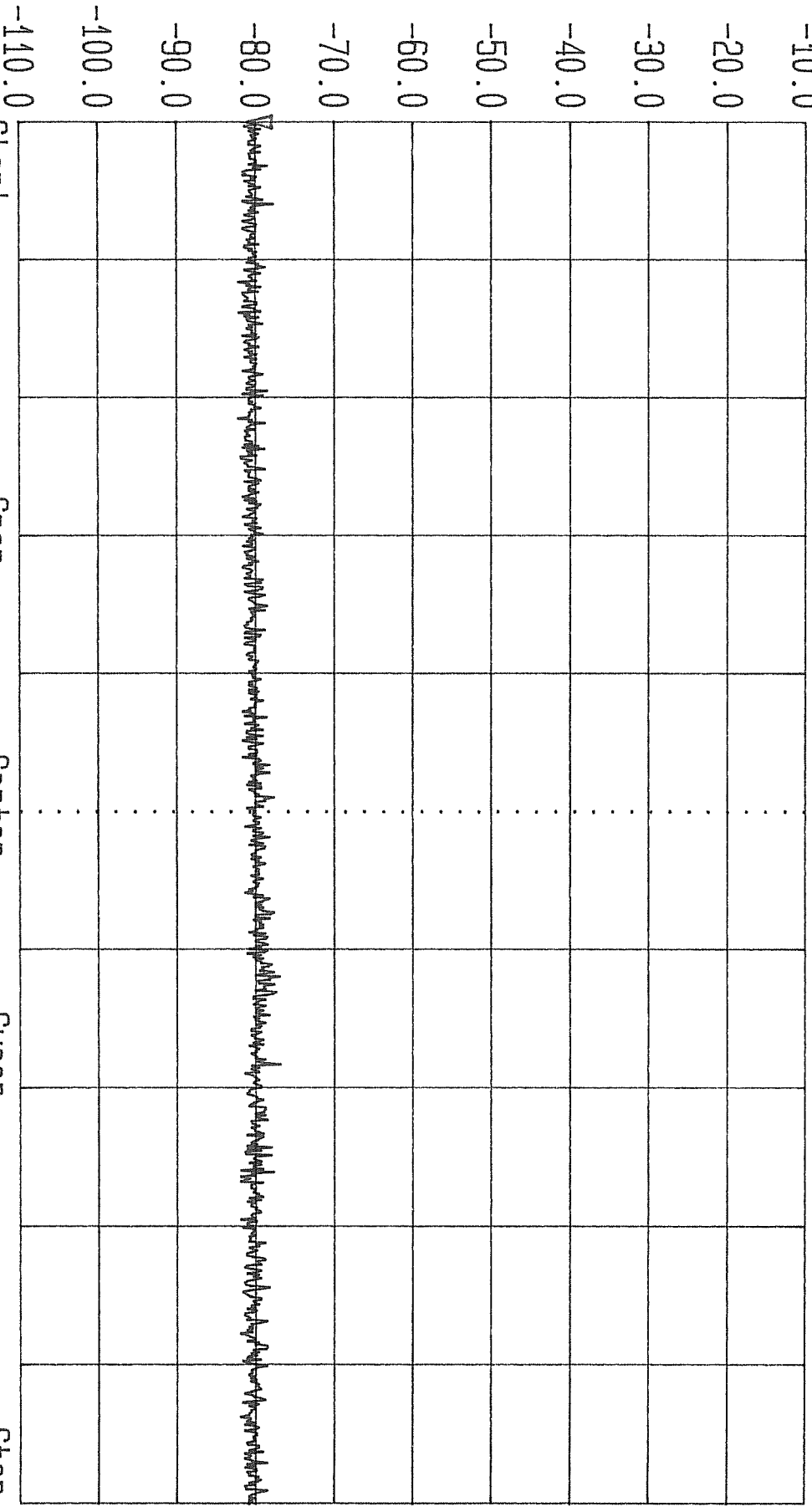

Start 20 GHz  
 Span 5 GHz  
 Center 22.5 GHz  
 Sweep 3.2 s  
 Stop 25 GHz  
 03-0193 CIRRONET HN110  
 MID CHANNEL

## **Data Plots**

**ACS Report Number: 03-0193-15B**

Manufacturer: Cirronet, Inc.  
Model: BT2022

**Test: Conducted Spurious Emissions**  
**Channel: High**





Date 08.Oct.'03 Time 16:11:21 MSG  
 Ref.Lvl -10.00 dBm Marker -53.85 dBm  
 1.0128 GHz Res.Bw 100 KHz [imp] 1 MHz  
 TG.Lvl 16.11:21 CF.Stp 252.000 MHz off Vid.Bw 10 dB  
 Unit RF.Att [dBm]

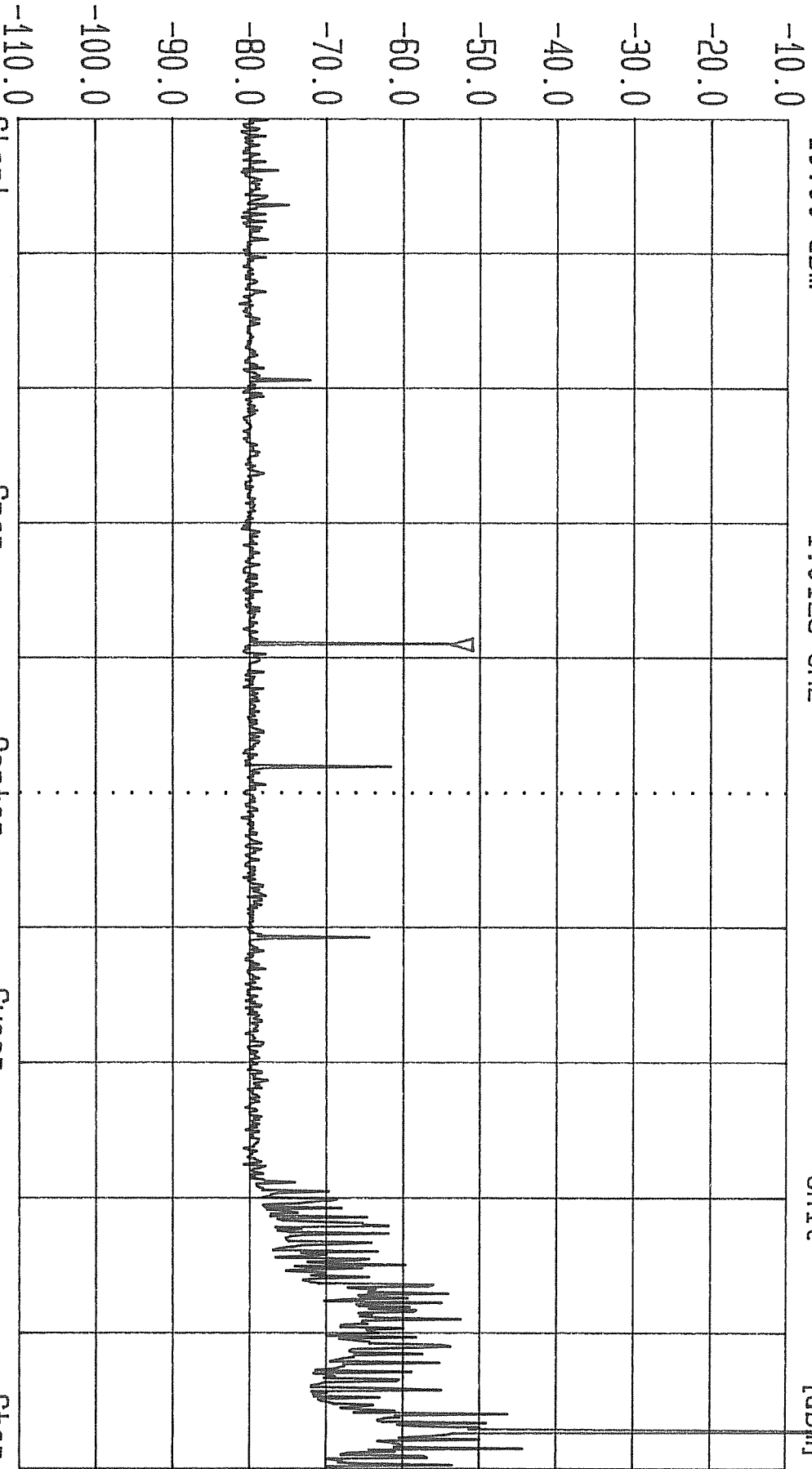

Start 0.030 GHz Span 2.52 GHz Center 1.29 GHz Sweep 1.60 s Stop 2.55 GHz  
 03-0193 CIRRONET HN110  
 HIGH CHANNEL



Date 08.Oct.'03 Time 16:26:11  
Ref.Lvl -10.00 dBm  
Marker -32.34 dBm  
4.9603 GHz

MSG  
Res.Bw 100 KHz [imp]  
TG.Lvl off  
CF.Stp 255.000 MHz  
Vid.Bw 1 MHz  
RF.Att Unit  
[dBm]

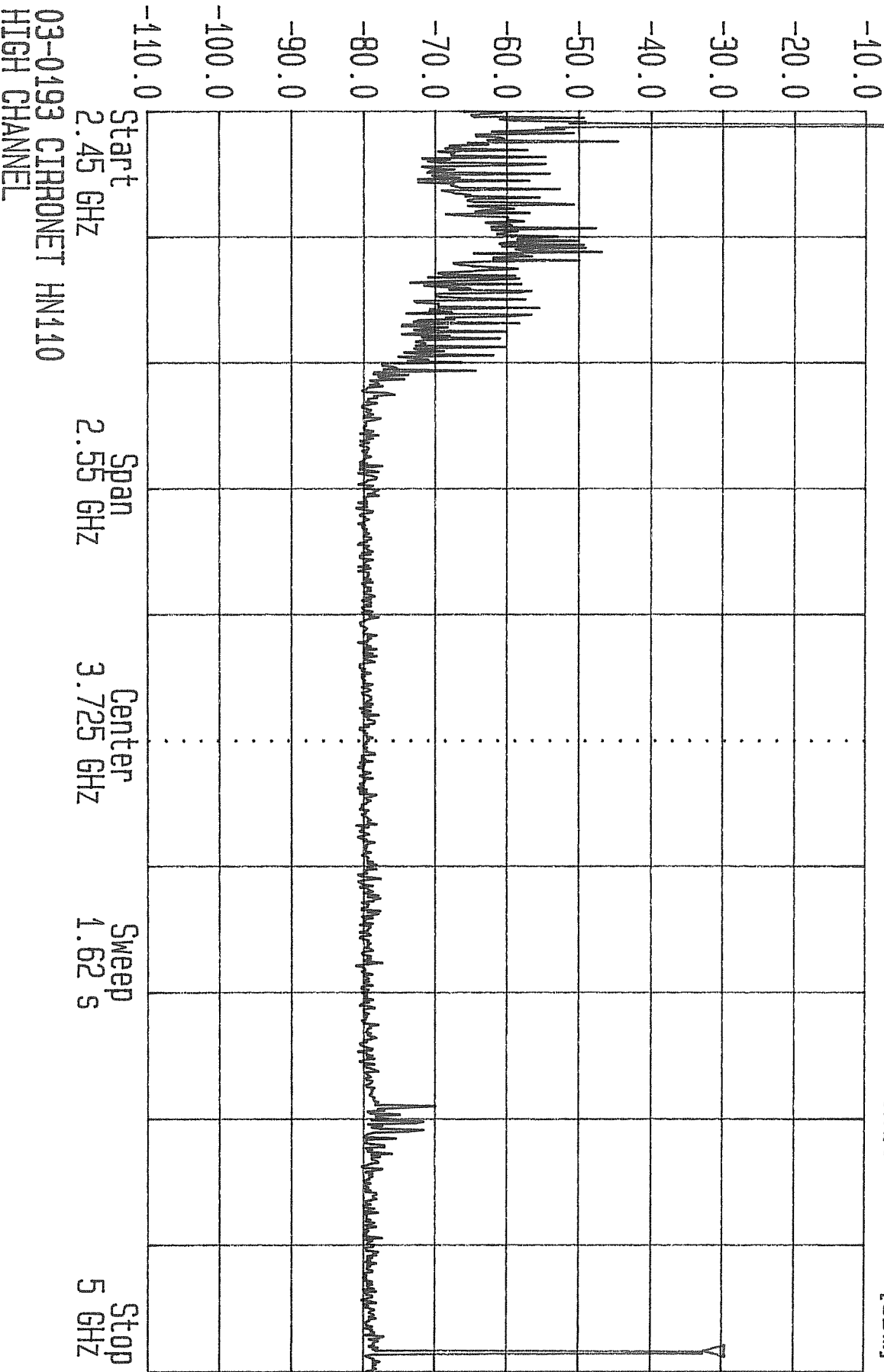



Date 08.Oct.'03 Time 16:33:43  
Ref.Lvl -10.00 dBm Marker -43.39 dBm  
9.9222 GHz

Res.Bw 100 KHz [imp]  
TG.Lvl off  
CF.Stp 500.000 MHz

Vid.Bw 1 MHz  
RF.Att Unit

1 MHz  
10 dB [dBm]

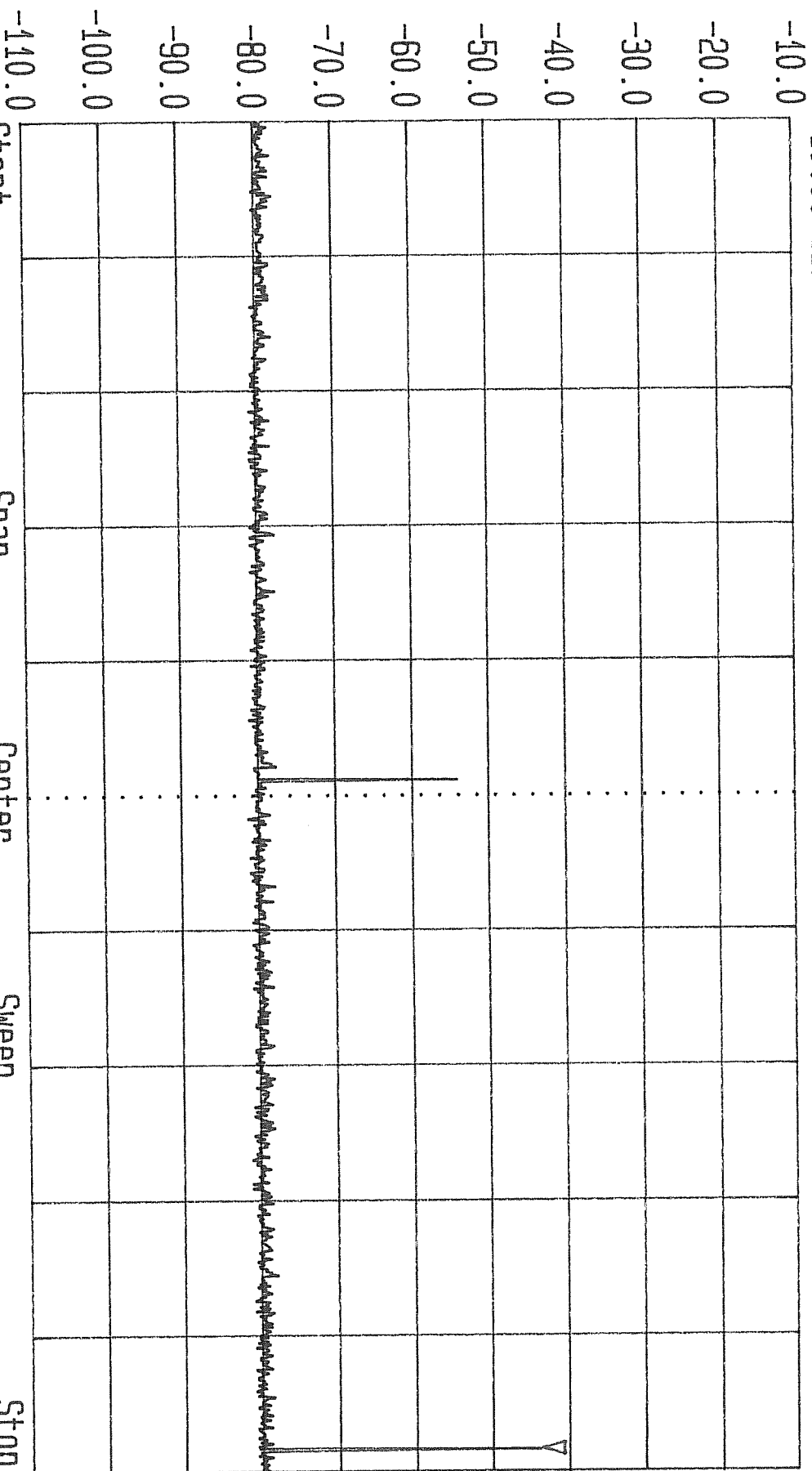

Start 5 GHz

Span 5 GHz

Center 7.5 GHz

Sweep 3.2 s

Stop 10 GHz

03-0193 CIRRONET HN110  
HIGH CHANNEL



Date 10.Oct.'03 Time 10:08:51  
 Ref.Lvl -10.00 dBm Marker -57.63 dBm  
 12.4000 GHz

Res.Bw 100 KHz [imp] Vid.Bw 1 MHz  
 TG.Lvl 1 CF.Stp 500.000 MHz off  
 RF.Att Unit 10 dB [dBm]

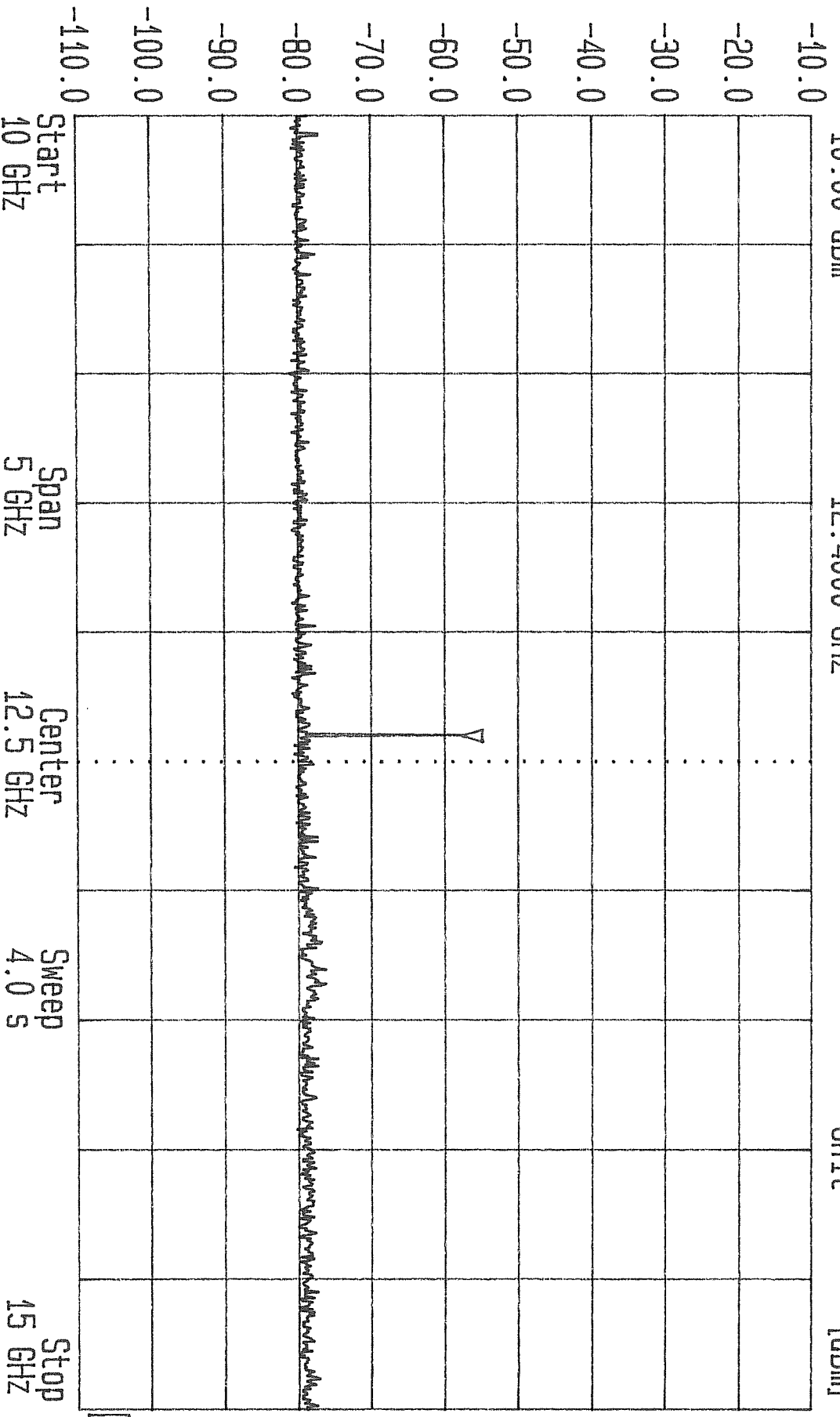

Start 10 GHz Span 5 GHz Center 12.5 GHz Sweep 4.0 s Stop 15 GHz

[FI]



Date 10.Oct.'03 Time 10:12:48  
 Ref.Lvl -10.00 dBm Marker -76.27 dBm  
 15.0000 GHz

Res.Bw 100 KHz [imp] Vid.Bw 1 MHz  
 TG.Lvl off  
 CF.Stp 500.000 MHz  
 RF.Att Unit 10 dB [dBm]

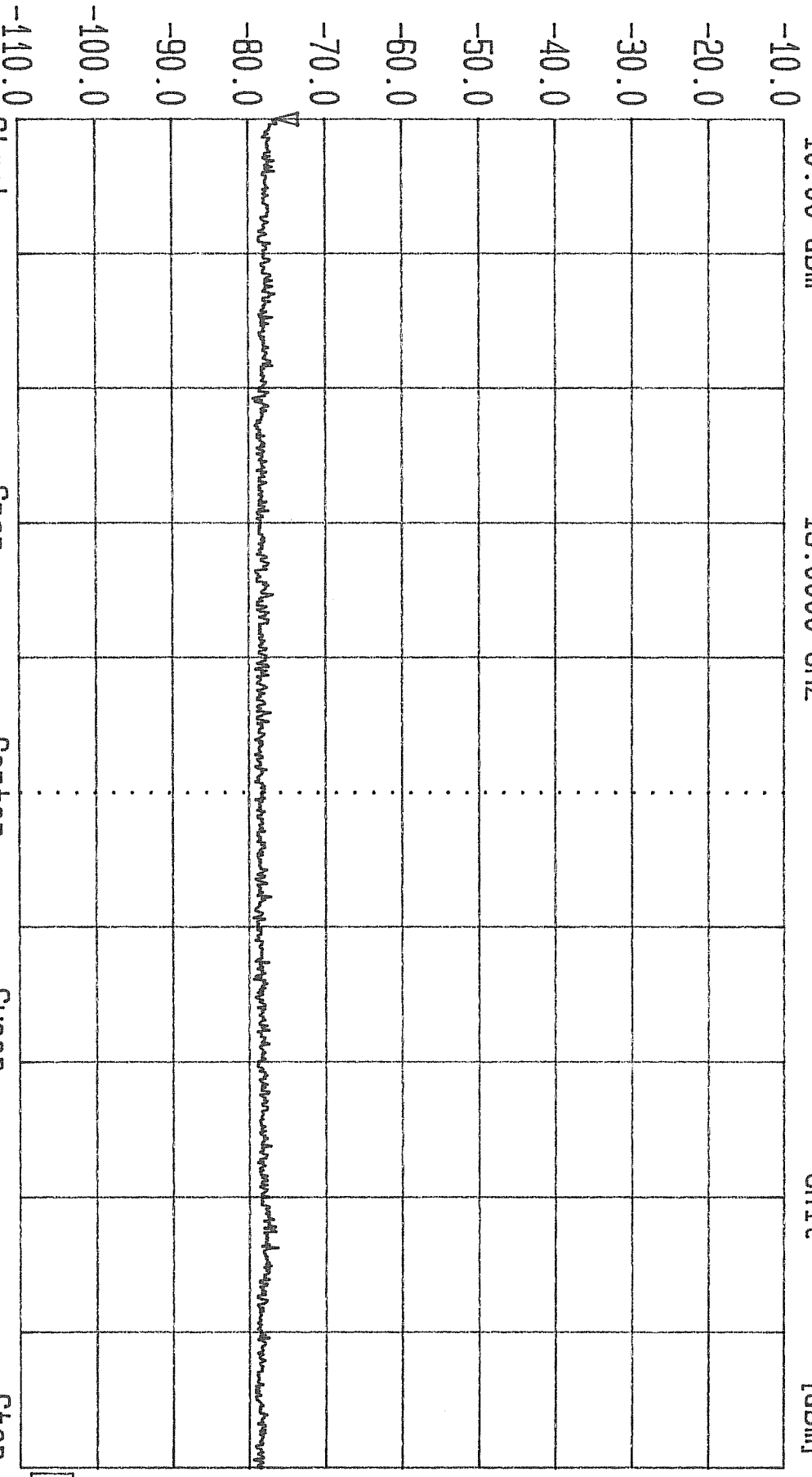

Start 15 GHz  
 Span 5 GHz  
 Center 17.5 GHz  
 Sweep 4.0 s  
 Stop 20 GHz

03-0193 CIRRONET HN110  
 HIGH CHANNEL

FI



Date 10.Oct.'03 Time 10:18:12  
 Ref.Lvl -10.00 dBm Marker -79.17 dBm  
 20.0000 GHz

Res.Bw 100 kHz [imp]  
 TG.Lvl off  
 CF.Stp 500.000 MHz  
 Vid.Bw 1 MHz  
 RF.Att Unit  
 10 dB [dBm]

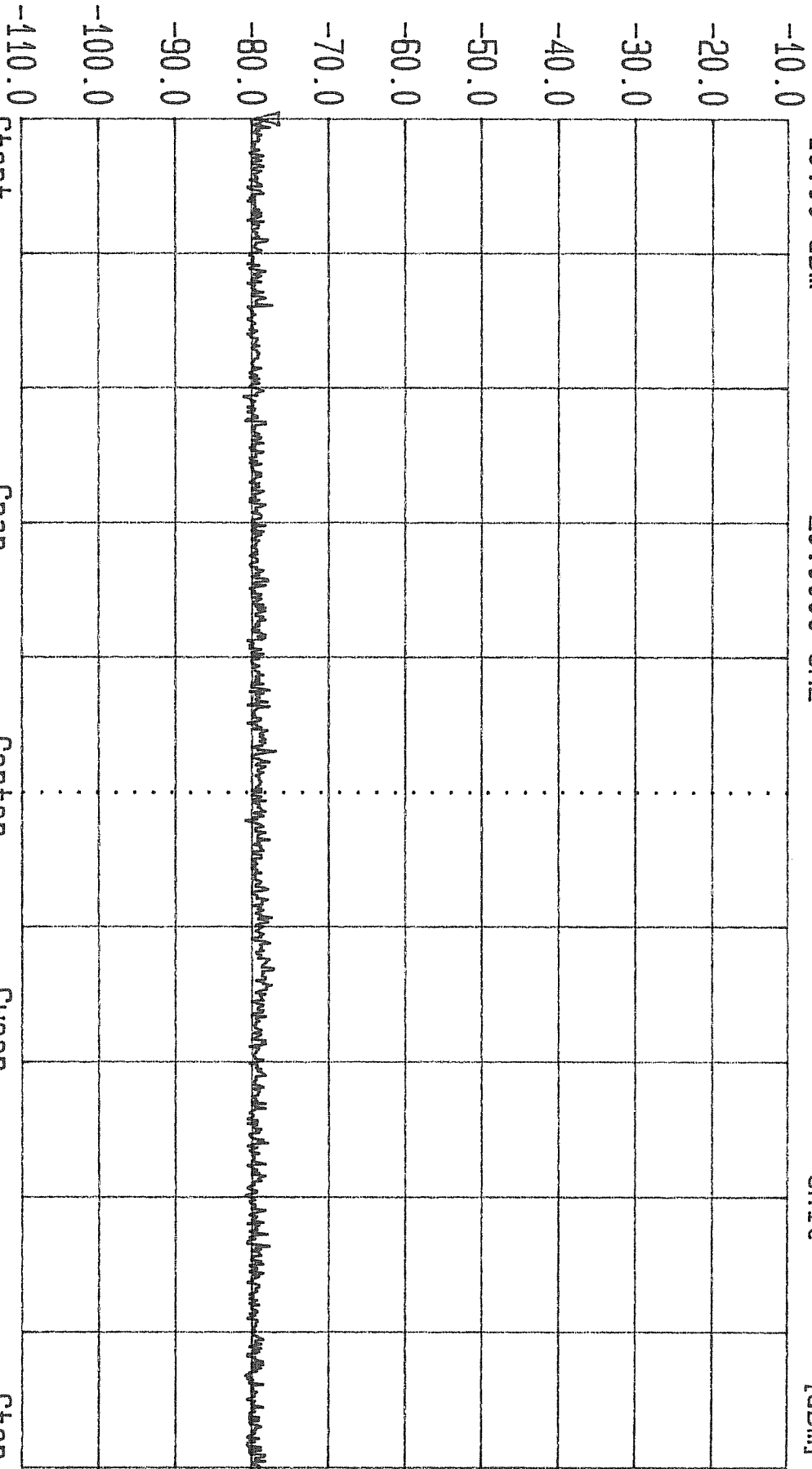

Start 20 GHz  
 Span 5 GHz  
 Center 22.5 GHz  
 Sweep 4.0 s  
 Stop 25 GHz

03-0193 CIRRONET HN110  
 HIGH CHANNEL

FI

**Part 15 Certification**  
**Test Report**

**2.4 GHz Frequency Hopping Spread Spectrum  
(Modular Approval)**

**FCC ID: HSW-BT2022M**

**FCC Rule Part: 15.247**

**ACS Report Number: 03-0193-15BC**

Manufacturer: Cirronet, Inc.  
Model: BT2022

**Data Plots B**

## Data Plots

**ACS Report Number: 03-0193-15B**

Manufacturer: Cirronet, Inc.  
Model: BT2022

**Test: Radiated Spurious Emissions**  
**Channel: Low**  
**Antenna: 2dBi Internal Patch**





Date 16.Oct.'03 Time 11:22:27 Res.Bw 1 MHz [imp] Vid.Bw 1 MHz  
Ref.Lvl 87.00 dBuV Marker 64.05 dBuV TG.Lvl 10 dB  
4.803855 GHz CF.Stp 500.000 KHz Off Unit [dBuV]

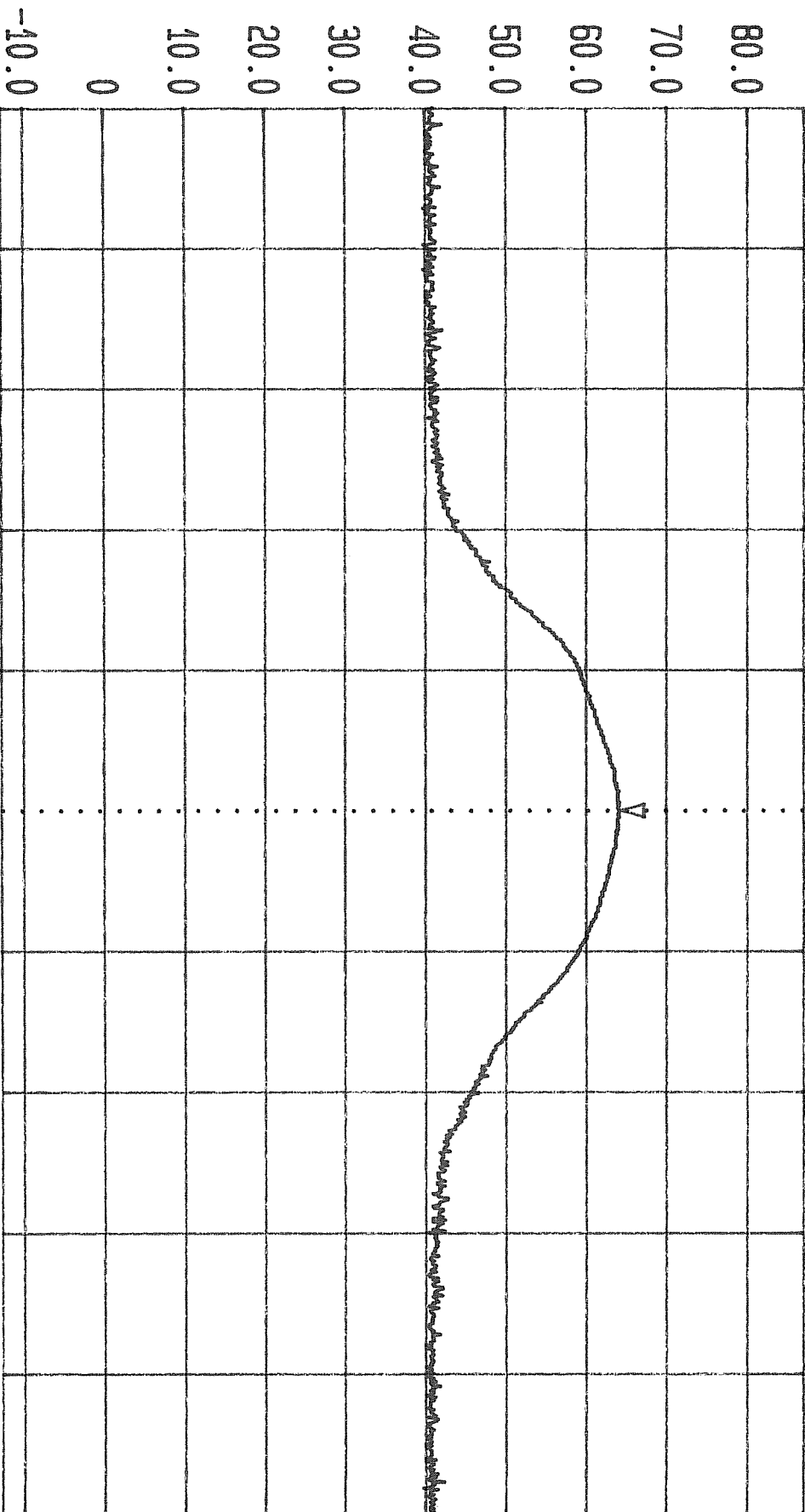

Start 4.801355555 GHz Span 5 MHz Center 4.803855555 GHz Sweep 20 ms Stop 4.806355555 GHz  
03-193 CIRRONET LOW CHANNEL



Date 16.Oct.'03 Time 11:26:50 Res.Bw 1 MHz [imp] Vid.Bw 10 Hz  
 Ref.Lvl 87.00 dBuV Marker 63.74 dBuV TG.Lvl off RF.Att 10 dB  
 4.803855 GHz CF.Stp 500.000 KHz Unit [dBuV]

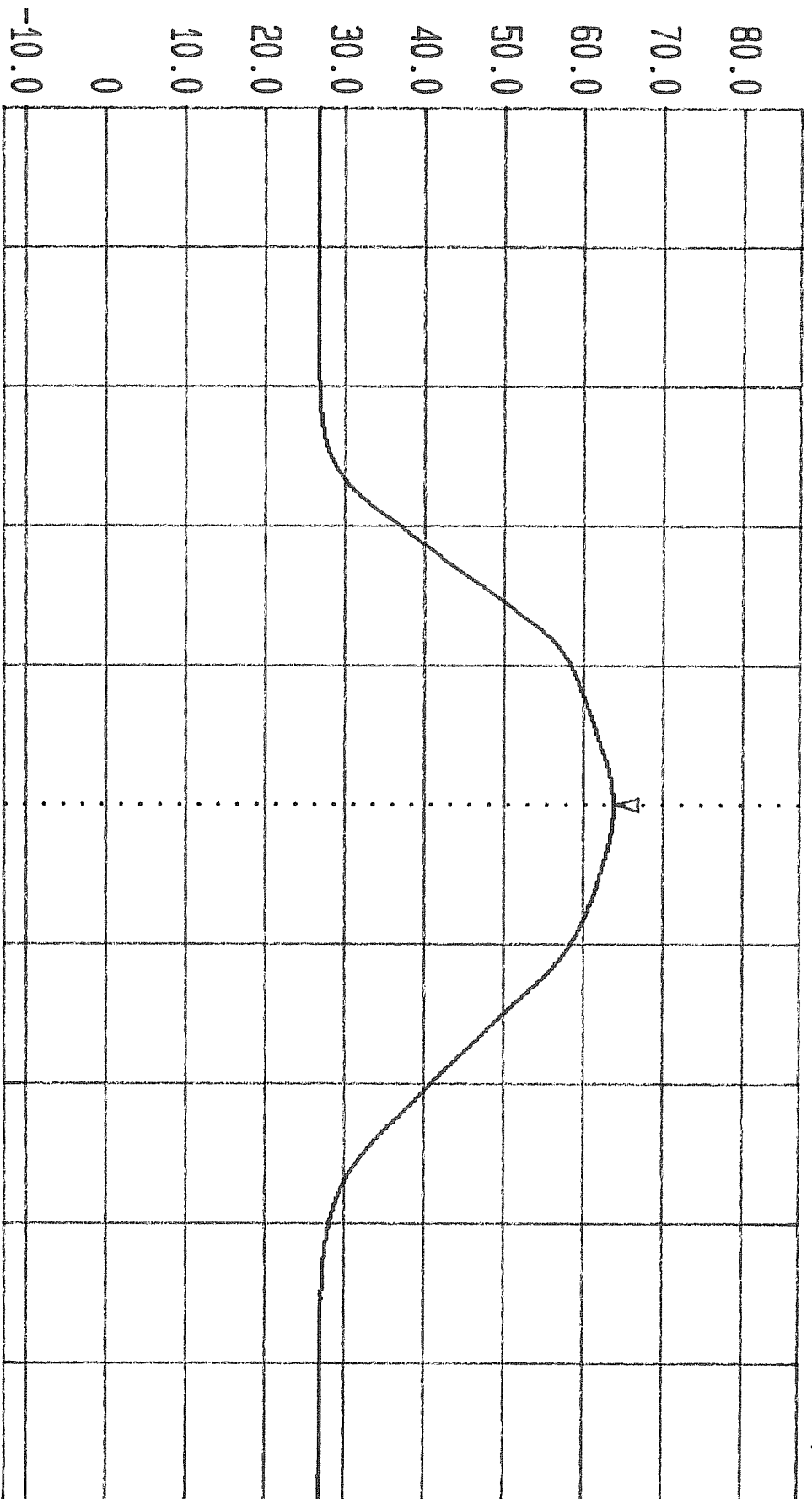

Start 4.801355555 GHz Span 5 MHz Center 4.803855555 GHz Sweep 11.0 s Stop 4.806355555 GHz  
 03-193 CIRRONE1  
 LOW CHANNEL



Date 16.Oct.'03 Time 11:30:49 Res.Bw 1 MHz [imp]  
Ref.Lvl 87.00 dBuV Marker 53.49 dBuV TG.Lvl 0ff Vid.Bw 1 MHz  
7.205855 GHz CF.Stp 500.000 KHz RF.Att Unit [dBuV]

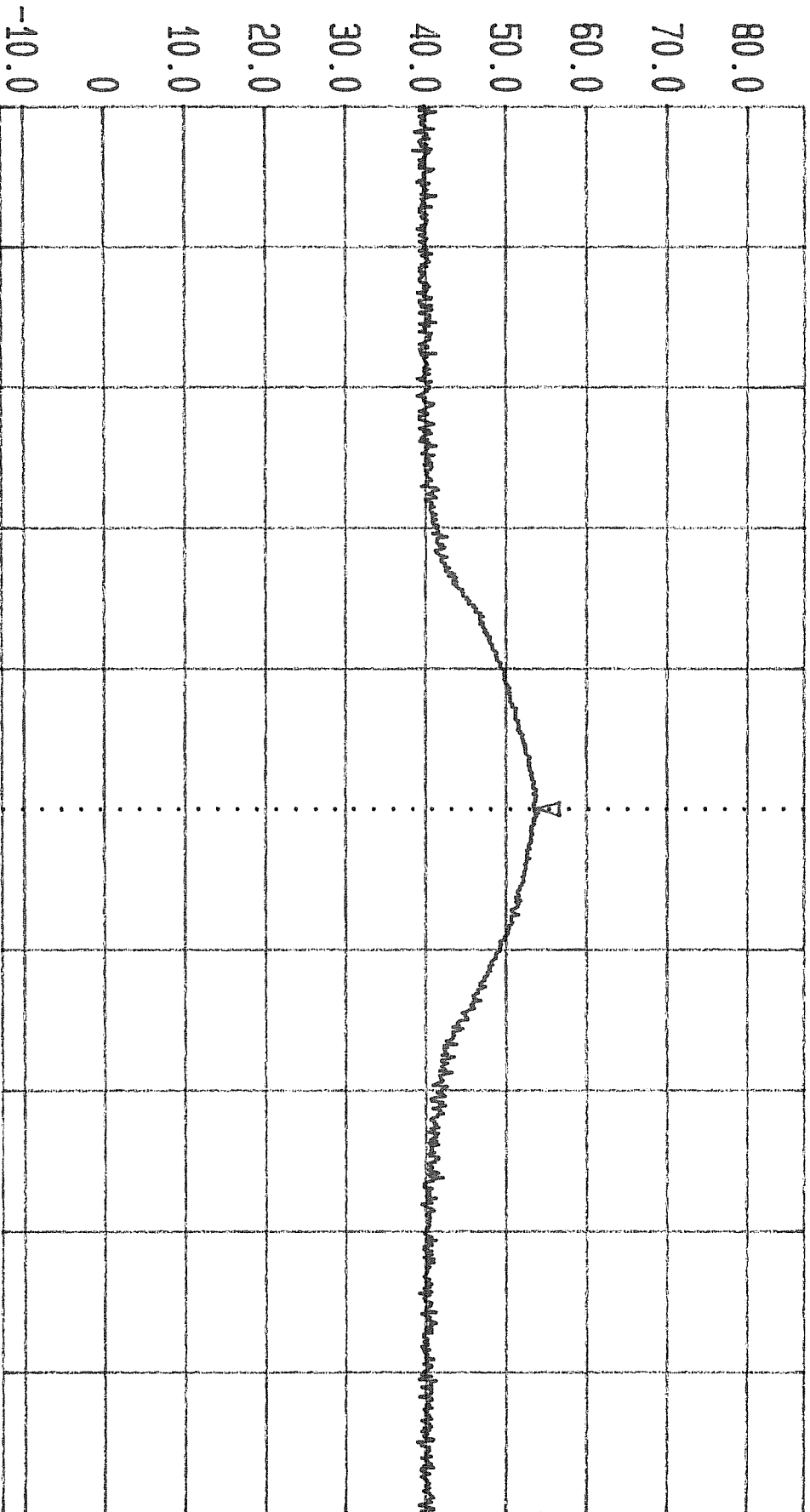

Start 7.203355555 GHz Span 5 MHz Center 7.205855555 GHz Sweep 20 ms Stop 7.208355555 GHz  
03-193 CIRRONET  
LOW CHANNEL



Date 16.Oct.'03 Time 11:34:43 Res.Bw 4 MHz [imp] Vid.Bw 10 Hz  
 Ref.Lvl 87.00 dBuV Marker 52.37 dBuV TG.Lvl1 10 dB  
 CF.Stp 7.205855 GHz 500.000 KHz Off Unit [dBuV]

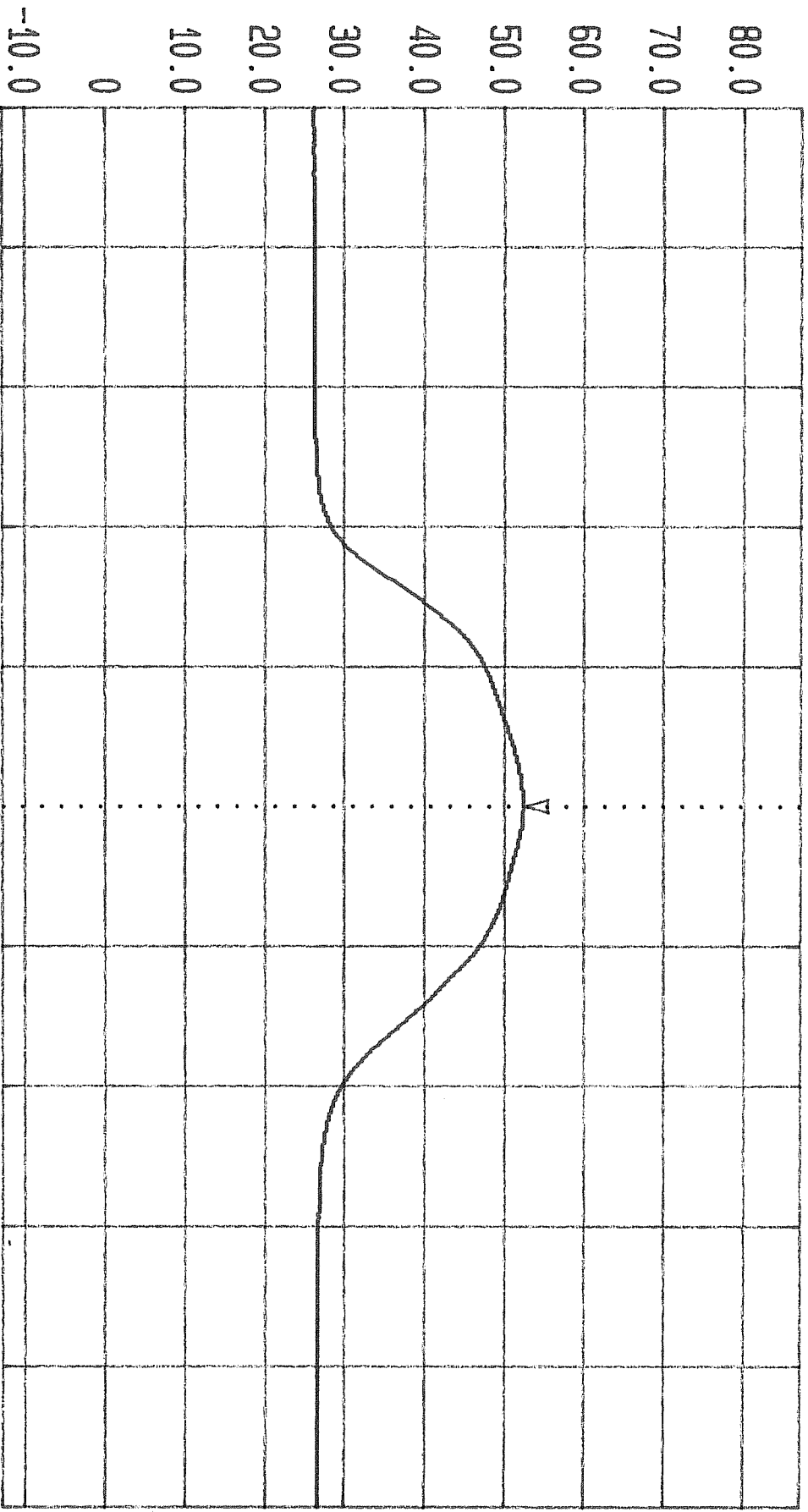

Start 7.203355555 GHz Span 5 MHz Center 7.205855555 GHz Sweep 11.0 s Stop 7.208355555 GHz  
 03-193 CIRRONET  
 LOW CHANNEL



Date 16.Oct.'03 Time 11:48:57 Res.Bw 1 MHz [imp] Vid.Bw 1 MHz  
 Ref.Lvl 87.00 dBuV Marker 45.16 dBuV T6.Lvl1 CF.Strp 500.000 KHz off RF.Att 10 dB  
 Unit [dBuV]

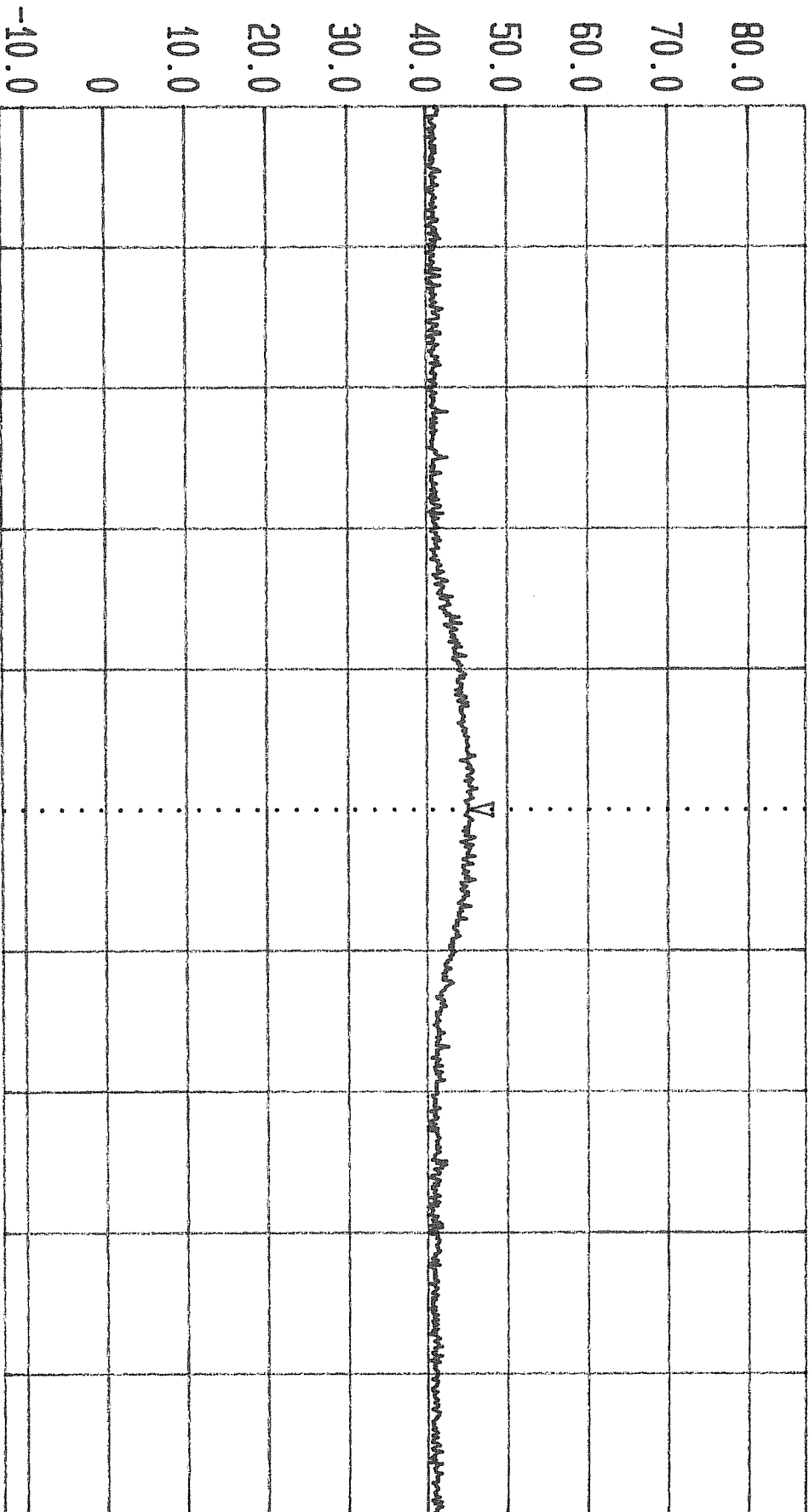

Start 9.605361111 GHz Span 5 MHz Center 9.607861111 GHz Sweep 20 ms Stop 9.610361111 GHz  
 03-193 CIRRONET  
 LOW CHANNEL



Date 16.Oct.'03 Time 11:52:55 Res.Bw 1 MHz [imp] Vid.Bw 10 Hz  
Ref.Lvl 87.00 dBuV Marker 40.26 dBuV T6.Lvl 10 dB  
9.607861 GHz CF.Stp 500.000 KHz off Unit [dBuV]

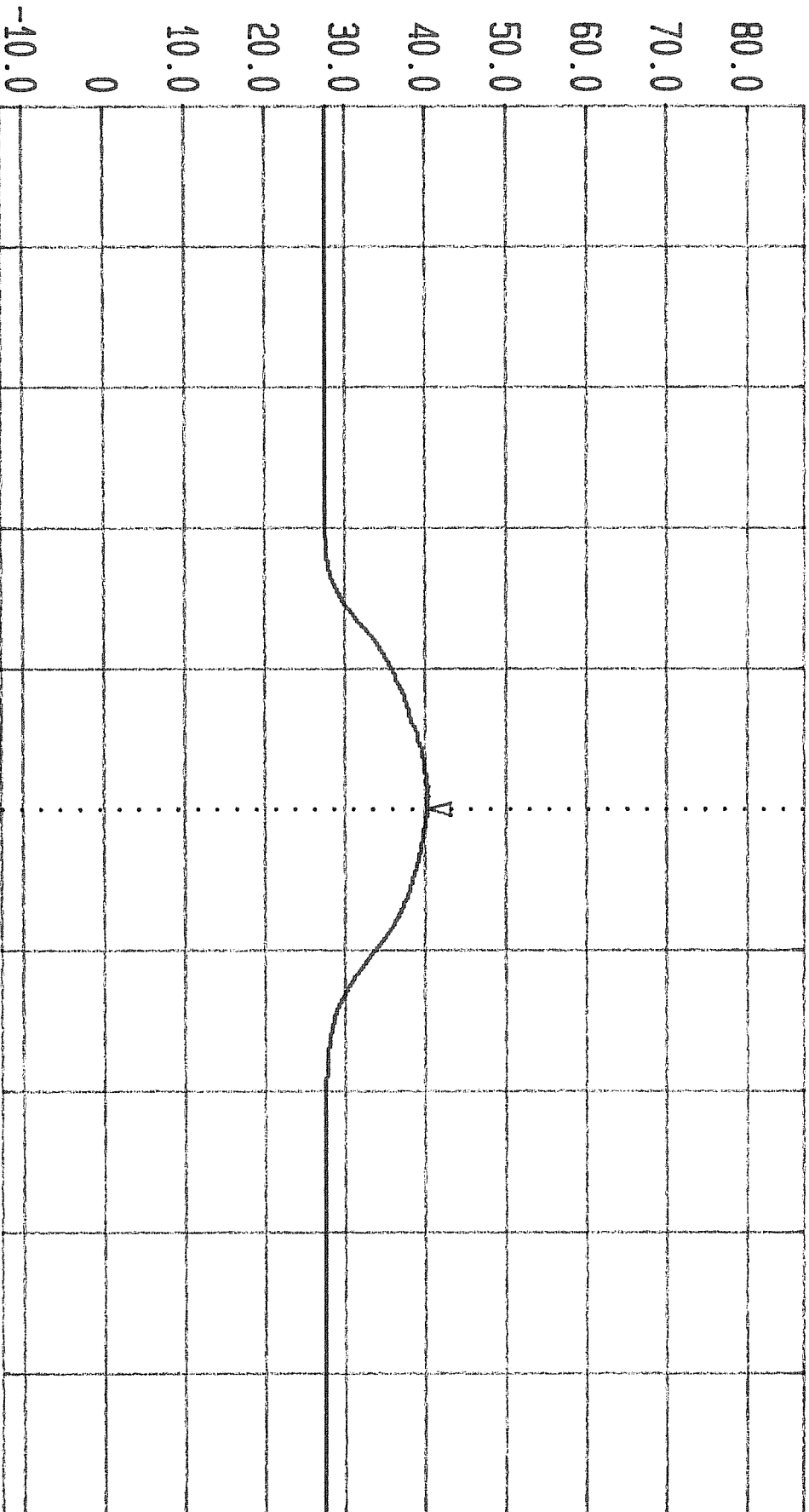

Start 9.605361111 GHz Span 5 MHz Center 9.607861111 GHz Sweep 11.0 s Stop 9.610361111 GHz  
03-193 CIRRONET LOW CHANNEL



Date 16.Oct.'03 Time 13:40:19 Res.BW 1 MHz [imp] Vid.BW 1 MHz  
 Ref.Lvl 87.00 dBuV Marker 40.08 dBuV TG.Lvl off 2.000 MHz RF.Att 10 dB  
 12.00900 GHz CF.Strp Unit [dBuV]

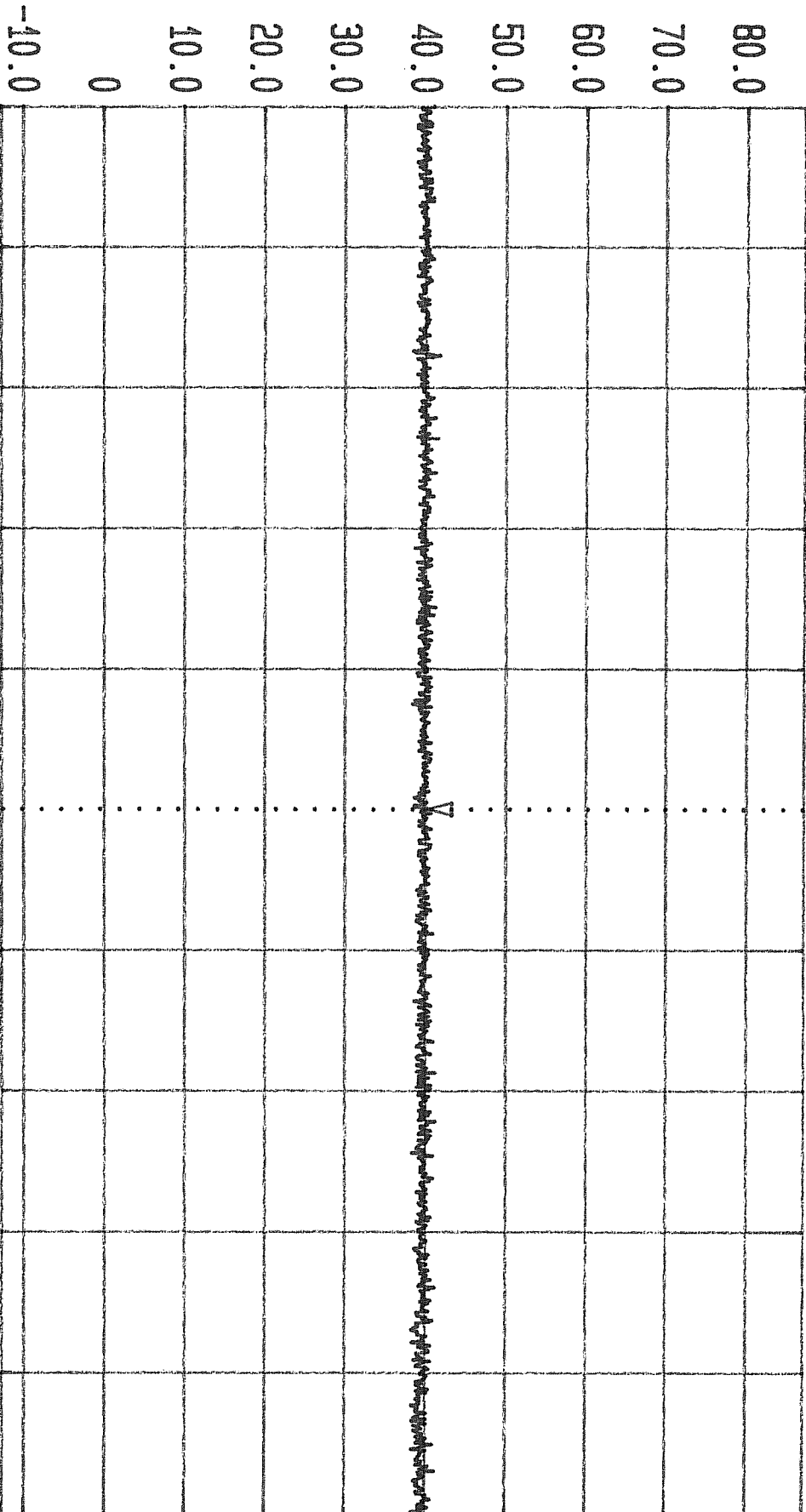

Start 11.999 GHz Span 20 MHz Center 12.009 GHz Sweep 20 ms Stop 12.019 GHz  
 03-193 CIRRONET LOW CHANNEL



Date 16.Oct.'03 Time 13:48:23  
 Ref.Lvl 87.00 dBuV  
 Marker 26.11 dBuV  
 12.00900 GHz

Res.Bw 16.Lvl  
 CF.Stp

1 MHz [imp]  
 off  
 2.000 MHz

Vid.Bw 10 Hz  
 RF.Att Unit  
 10 dB [dBuV]

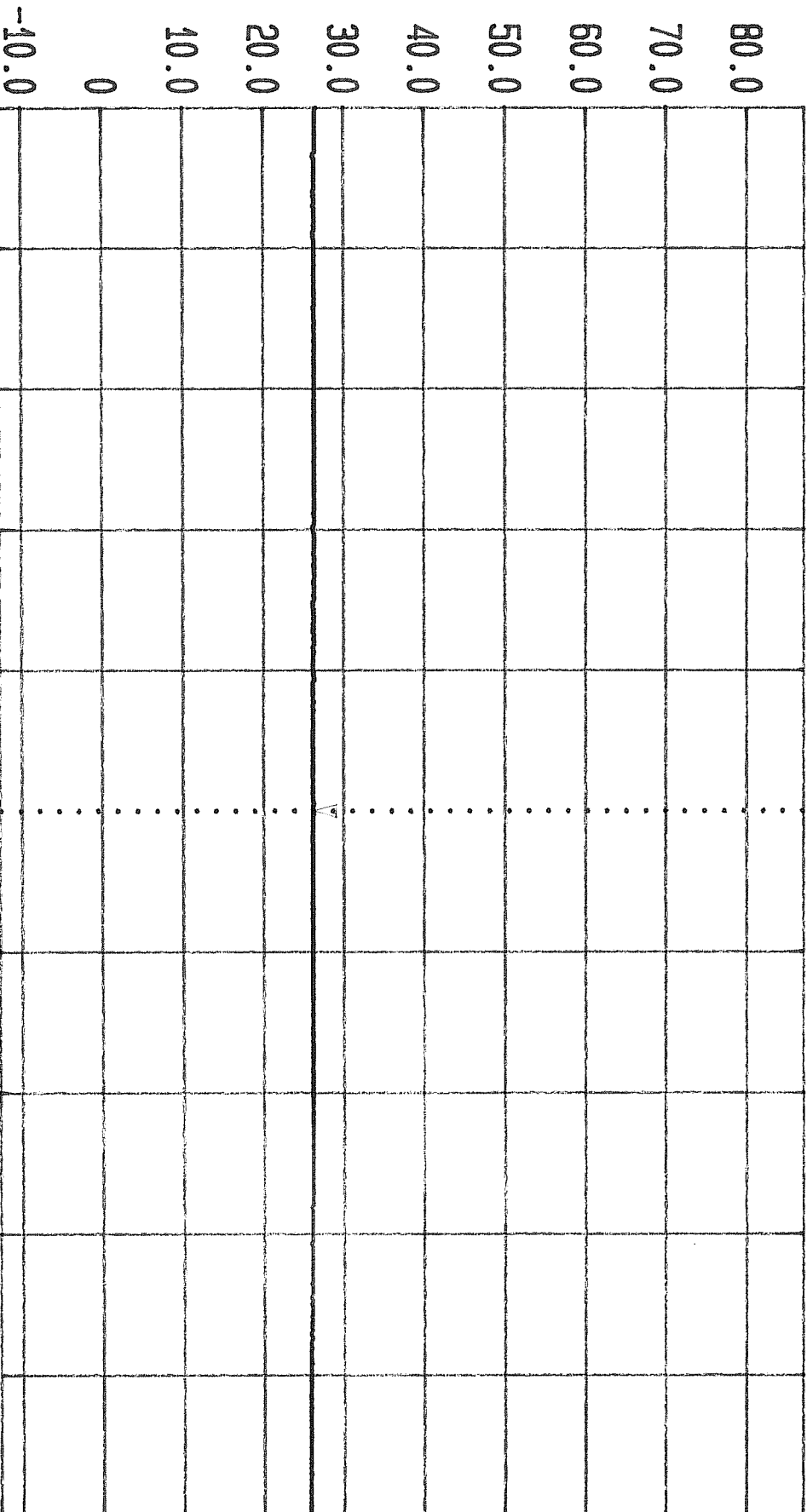

Start 11.999 GHz  
 Span 20 MHz  
 Center 12.009 GHz  
 Sweep 15.0 s  
 Stop 12.019 GHz

03-193 CIRRONET  
 LOW CHANNEL



## Data Plots

**ACS Report Number: 03-0193-15B**

Manufacturer: Cirronet, Inc.  
Model: BT2022

**Test: Radiated Spurious Emissions**  
**Channel: Center**  
**Antenna: 2dBi Internal Patch**



Date 16.Oct.'03 Time 13:52:52  
Ref.Lvl 87.00 dB $\mu$ V  
Marker 62.63 dB $\mu$ V  
4.881844 GHz

Res.Bw 1 MHz [imp]  
TG.Lvl Off  
CF.Stp 500.000 kHz  
Vid.Bw 1 MHz  
AF.Att 10 dB  
Unit [dB $\mu$ V]

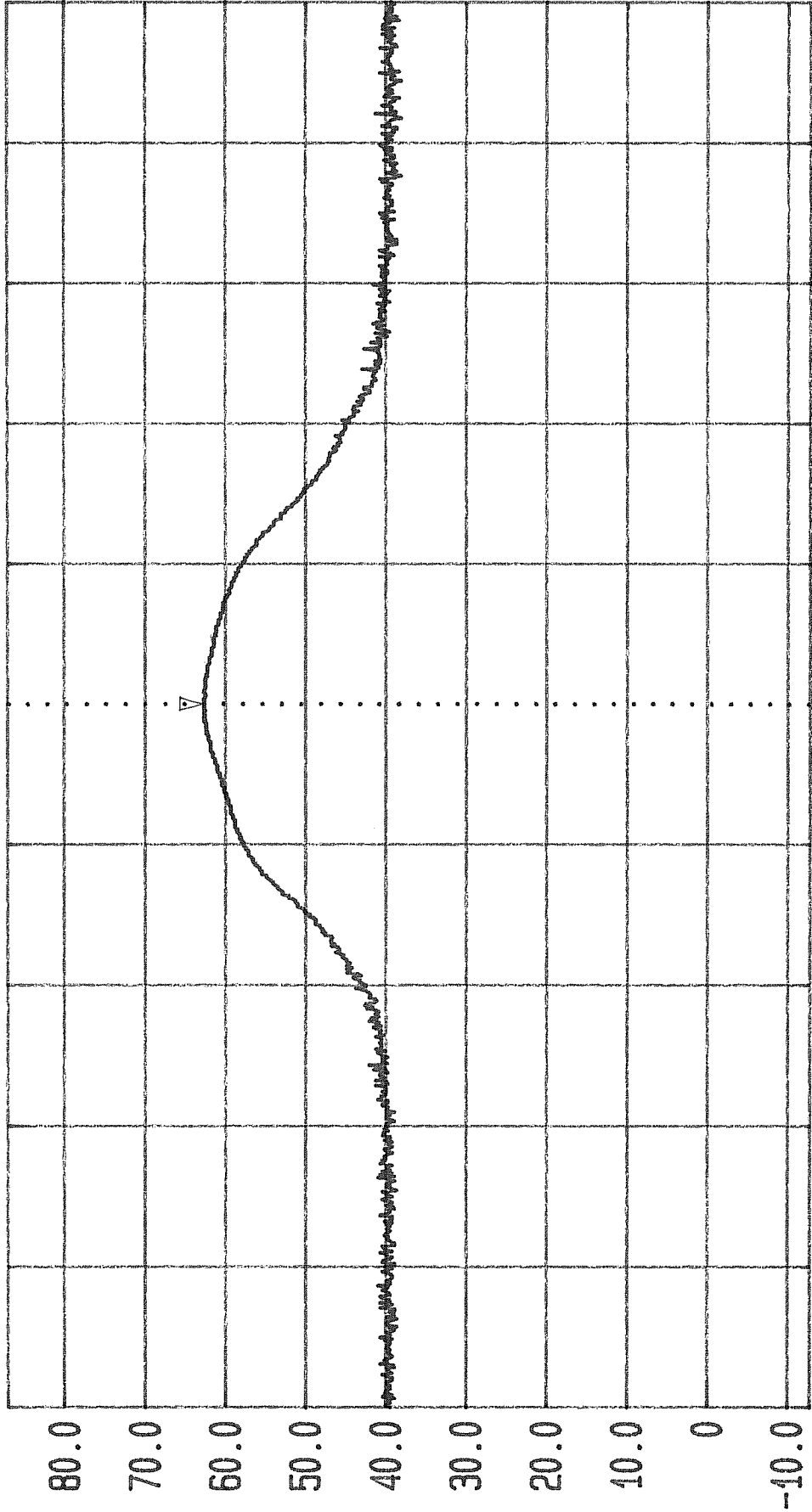

Start 4.879344444 GHz  
Span 5 MHz  
Center 4.881844444 GHz  
Sweep 20 ms  
Stop 4.884344444 GHz

03-193 CIRRONET  
MID CHANNEL



Date 16.Oct.'03 Time 14:11:18  
Ref.Lvl 87.00 dB $\mu$ V  
Marker 62.93 dB $\mu$ V  
4.881844 GHz

Res.Bw 1 MHz [imp]  
TG.Lvl Off  
CF.Stp 500.000 kHz  
Vid.Bw 10 Hz  
RF.Att 10 dB  
Unit [dB $\mu$ V]

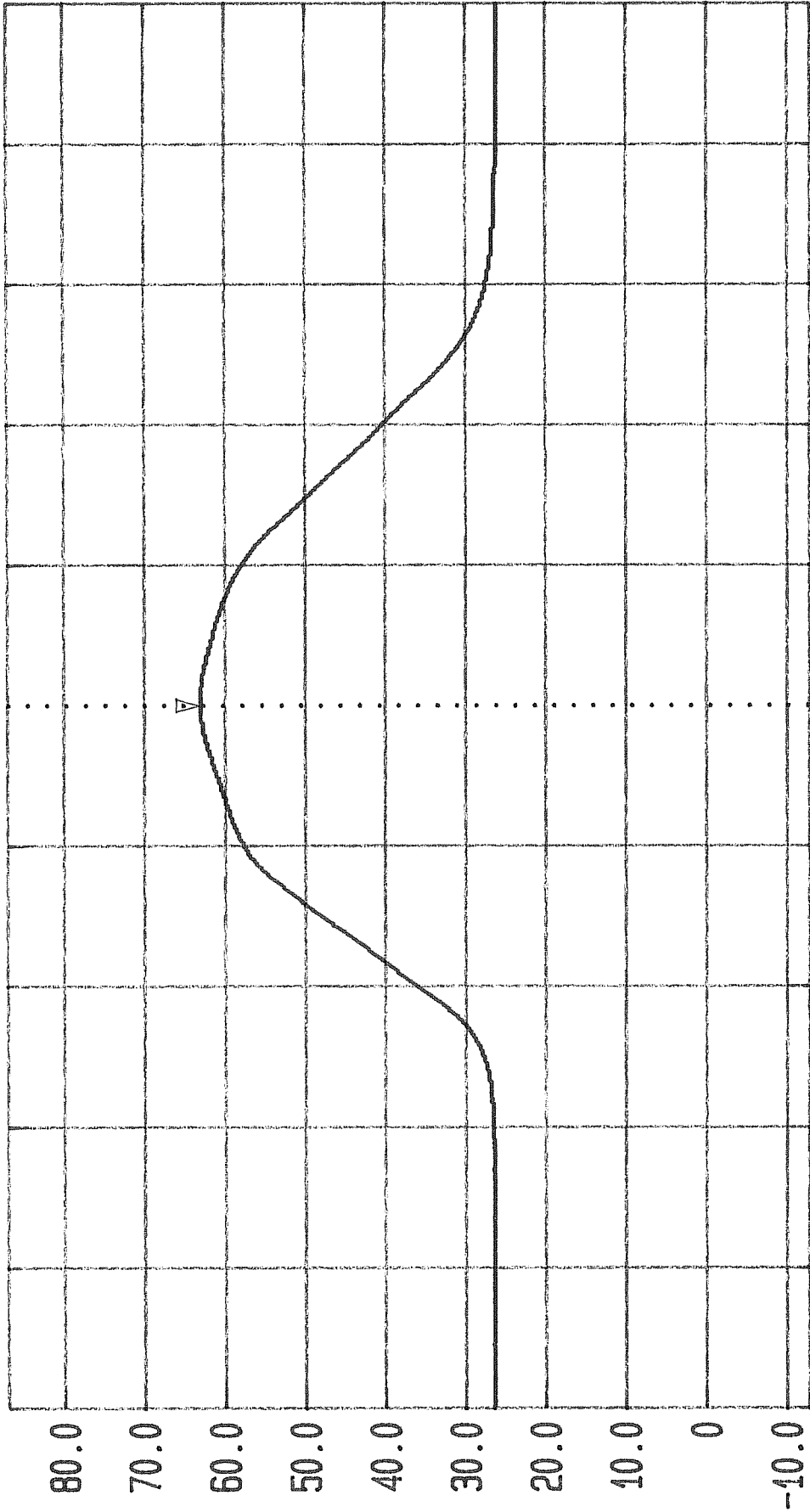

Start 4.879344444 GHz  
Center 4.881844444 GHz  
Span 5 MHz  
Sweep 11.0 s  
Stop 4.884344444 GHz

03-193 CIRRONET  
MID CHANNEL



Date 16.Oct.'03 Time 14:30:44  
Ref.Lvl 87.00 dB $\mu$ V  
Marker 53.69 dB $\mu$ V  
7.322866 GHz

Res.Bw 1 MHz [imp]  
TG.Lvl Off  
CF.Stp 500.000 kHz  
Vid.Bw 1 MHz  
RF.Att 10 dB  
Unit [dB $\mu$ V]

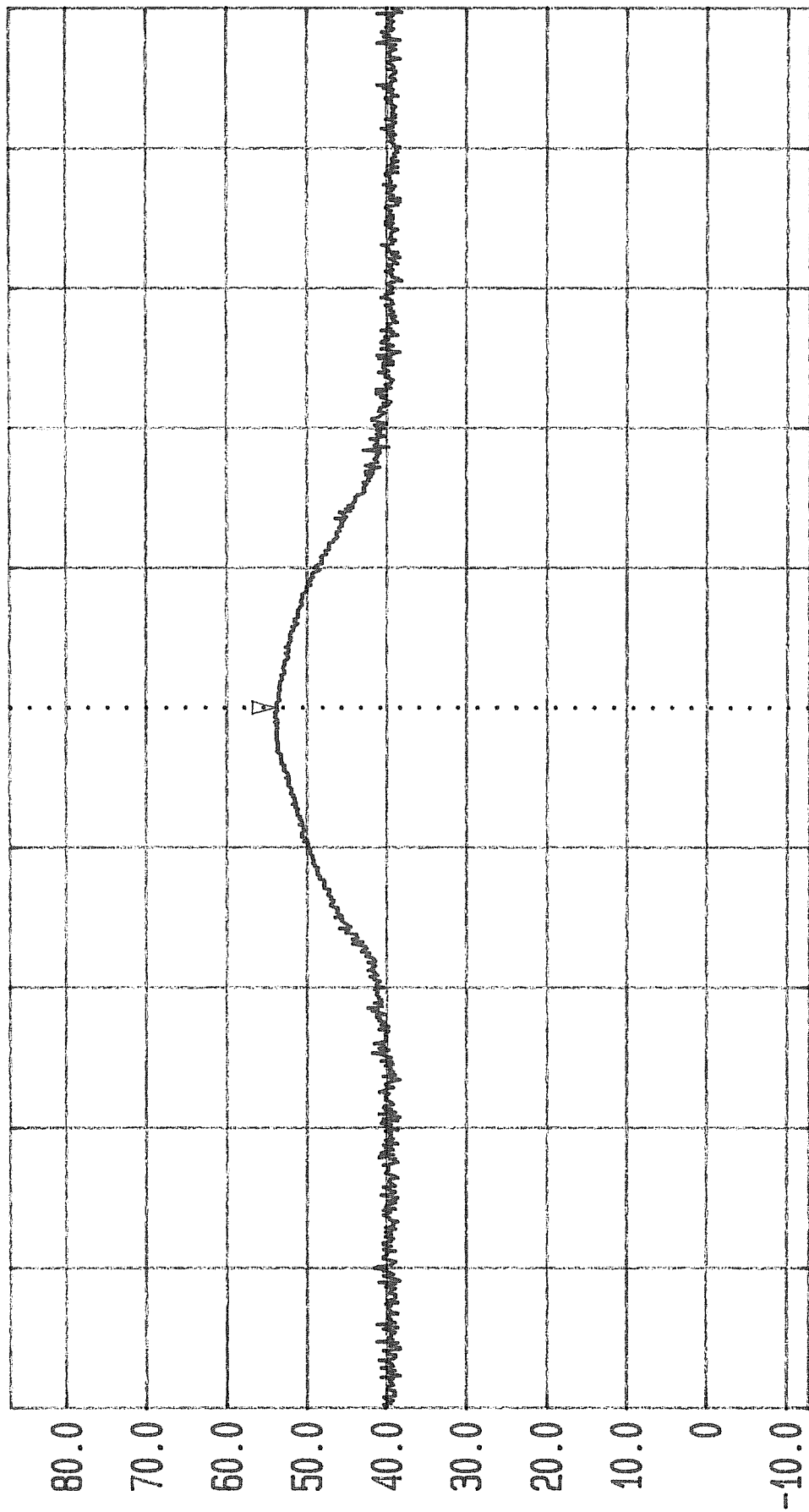

Start 7.320366666 GHz  
Span 5 MHz  
Center 7.322866666 GHz  
Sweep 20 ms  
Stop 7.325366666 GHz

03-193 CIRRONET  
MID CHANNEL



Date 16.Oct.'03 Time 15:07:14  
Ref.Lvl 87.00 dBμV  
Marker 51.86 dBμV  
7.322866 GHz

Res.Bw 1 MHz [imp]  
TG.Lvl Off  
CF.Stp 500.000 kHz  
Vid.Bw 10 Hz  
RF.Att 10 dB  
Unit [dBμV]

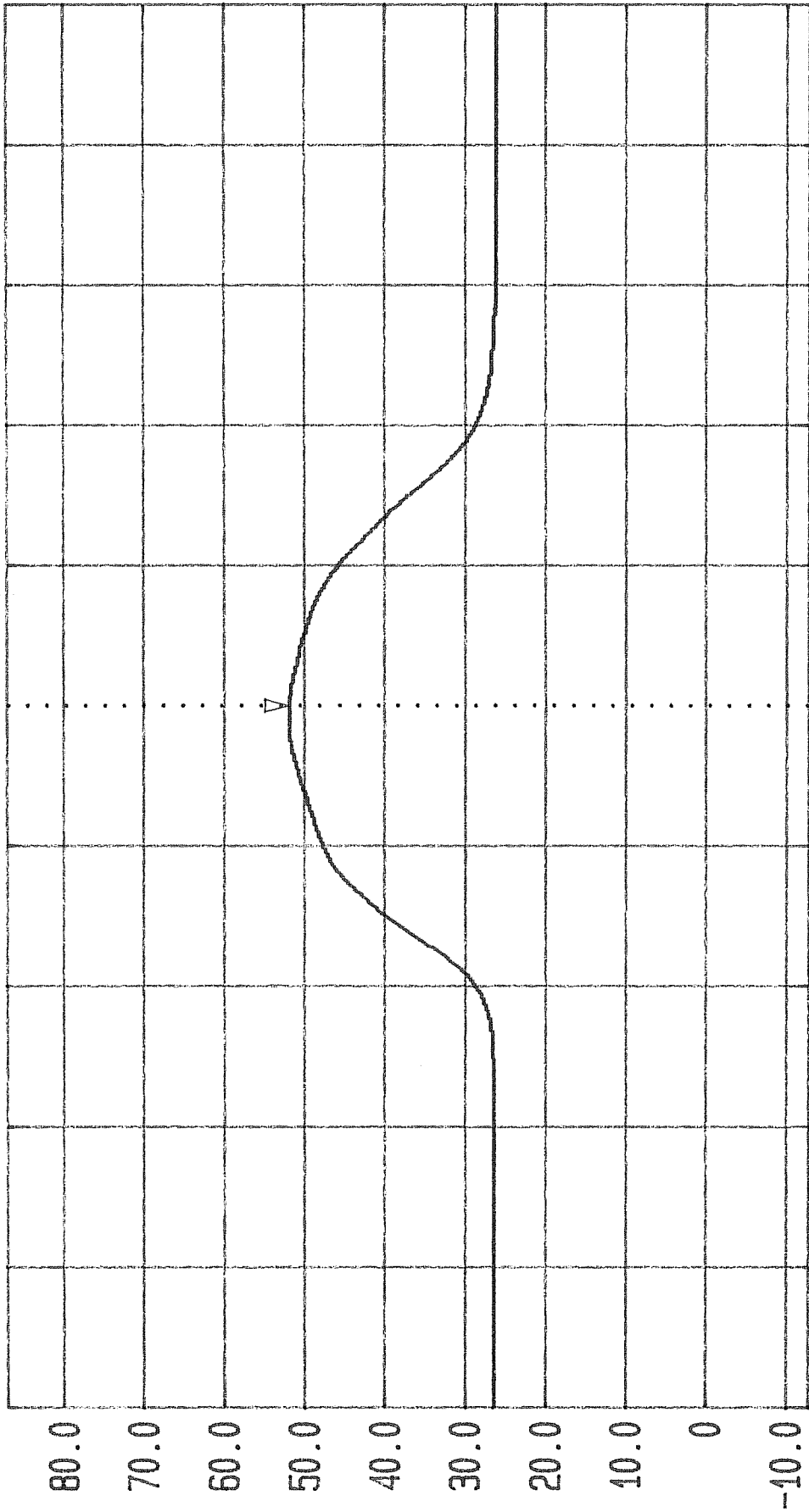

Start 7.320366 GHz  
Span 5 MHz  
Center 7.322866 GHz  
Sweep 11.0 s  
Stop 7.325366 GHz

03-193 CIRRONET  
MID CHANNEL

## Data Plots

**ACS Report Number: 03-0193-15B**

Manufacturer: Cirronet, Inc.  
Model: BT2022

**Test: Radiated Spurious Emissions**  
**Channel: High**  
**Antenna: 2dBi Internal Patch**

# 03-0193 Max Peak Plots – High Channel

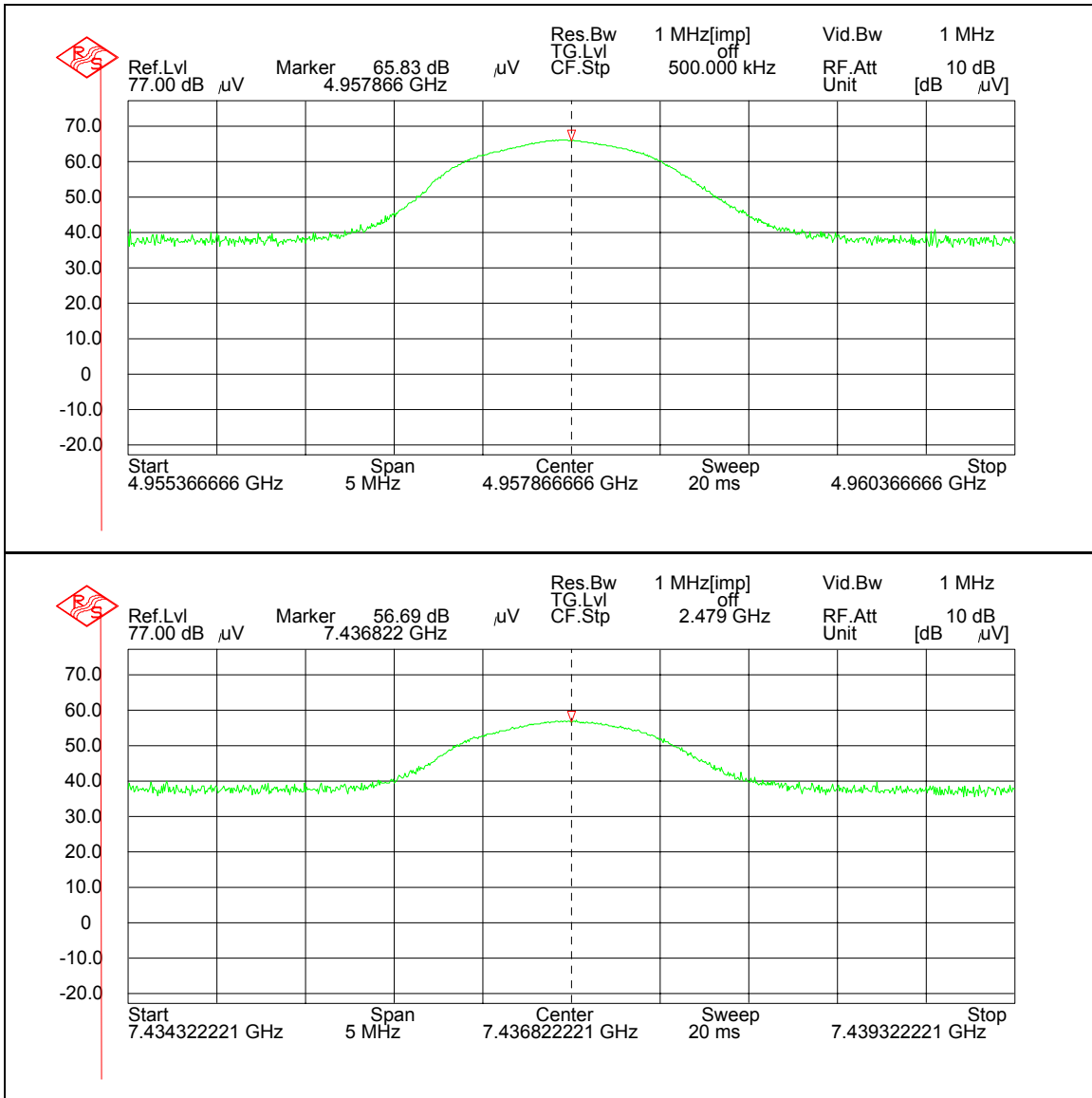

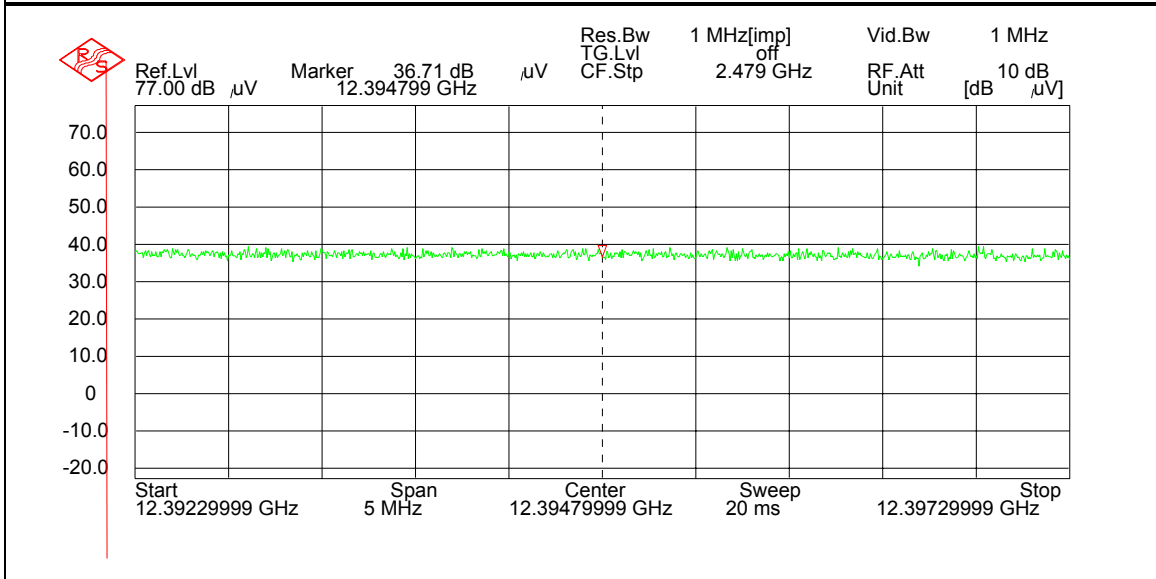
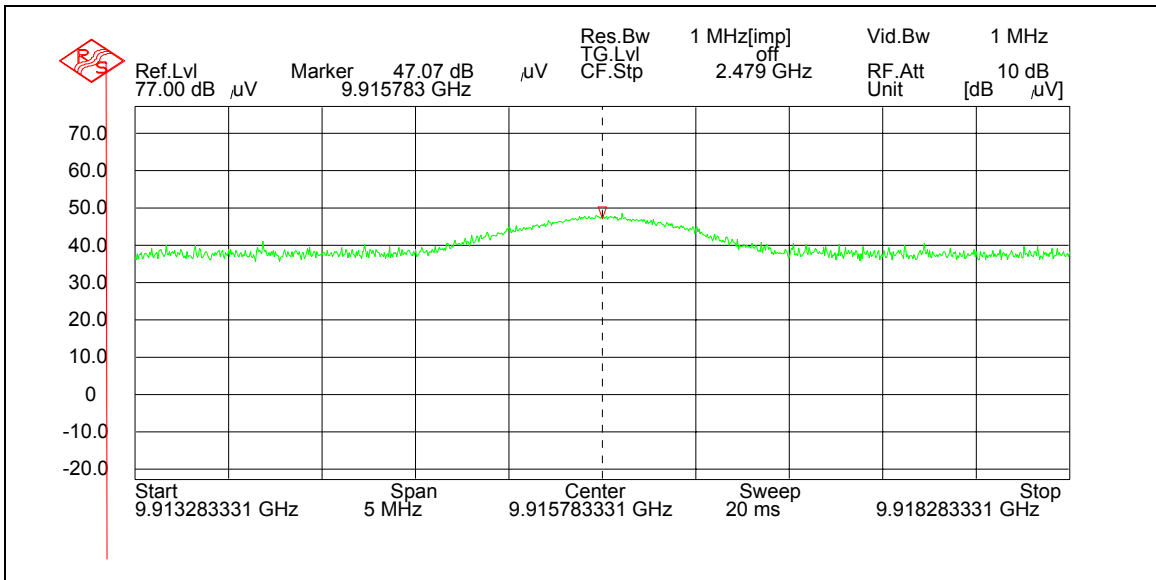



# 03-0193 Average Plots – High Channel

