



Class II Permissive Change
Test Report
And Application for Grant of Equipment Authorization

TEST REPORT PERTAINING TO:

Equipment Under Test	Model Number(s)
Intel Wireless WiFi Link 4965AGN	4965AGN

CONFIGURATION
802.11a / 802.11b / 802.11g / 802.11n with a set of Sony IRX-3980 Antennas

MEASUREMENTS PERFORMED IN ACCORDANCE WITH THE FOLLOWING STANDARD (S)

Regulatory Standard(s)
47 CFR Part 15, Subpart C Section 15.247
Test Method: ANSI C63.4: 2003 American National Standard for Methods of Measurement of Radio-Noise Emissions from Low-Voltage Electrical and Electronic Equipment in the Range of 9 kHz to 40 GHz



Certificate Number: 1111.01

PREPARED FOR:

Intel Corporation
2111 NE 25th Avenue
Hillsboro, Oregon 97124
Contact(s): Mr. Robert Paxman

PREPARED BY:

Aegis Labs, Inc.
22431 Antonio Parkway B160-417
Rancho S. Margarita, CA 92688
Agent(s): Mr. Rick Candelas
Mr. Johnny Candelas



Test Report #: INTEL-070320F

Test Report Revision: NONE

	REPORT BODY	APPENDICES		TOTAL PAGES
		A	B	
PAGES	22	112	1	135

The contents of this report shall not be reproduced except in full, without the written approval of Aegis Labs, Inc.
The Intel logo is used for identification purposes only and is a registered trademark of Intel Corporation



TABLE OF CONTENTS

SECTION	TITLE	PAGE
	COVER SHEET.....	01
	TABLE OF CONTENTS.....	02
1.0	REGULATORY COMPLIANCE GUIDELINES.....	03
1.1	Guidelines For Testing To Emissions Standards.....	03
2.0	SUMMARY OF REGULATORY LIMITS.....	04
3.0	ADMINISTRATIVE DATA AND TEST DESCRIPTION.....	16
4.0	DESCRIPTION OF EUT CONFIGURATION.....	17
4.1	EUT Description	17
4.2	EUT Configuration.....	18
4.3	List of EUT Sub-Assemblies and Host Equipment.....	18
4.4	I/O Cabling Diagram and Description	19
4.5	EMC Test Hardware and Software Measurement Equipment.....	20
5.0	CONDITIONS DURING EMISSIONS MEASUREMENTS.....	21
5.1	General.....	21
5.2	Conducted Emissions Test Setup.....	21
5.3	Radiated Emissions Test Setup.....	22

APPENDICES

A	Test Data
B	Modifications And Recommendations



1.0 REGULATORY COMPLIANCE GUIDELINES

Aegis Labs, Inc. operates as both a Nevada and California Corporation with no organizational or financial relationship with any company, institution, or private individual. Testing and engineering functions provided by Aegis Labs were furnished by RF technicians and engineers with accredited qualifications and training credentials to carry out their duties.

The object of this report was to publish verifiable test results of an EUT subjected to the tests outlined in the standard listed on the cover page of this report.

1.1 Guidelines For Testing To Emissions Standards

This standard for EMC emission requirements apply to electrical equipment for Information Technology Equipment (ITE). Compliance to these standards and in combination with the other standards listed in this test report can be used to demonstrate presumption of compliance with the protection requirements of the appropriate agency standard.

The purpose of this standard is to specify minimum requirements for emissions regarding electromagnetic compatibility (EMC) and protect the radio frequency spectrum 9 kHz. – 400 GHz. from unwanted interference generated from electrical/digital systems that intentionally or unintentionally generated RF energy. The emissions standards, normative documents and/or publications were used to conduct all tests performed on the equipment herein referred to as “Equipment Under Test”.



2.0 SUMMARY OF TEST RESULTS

802.11a Mode (5745-5825 MHz) Chain A

EMISSIONS STANDARD

FCC Part 15 Section	Description	Results	Comments
15.247(a)(2)	The minimum 6dB bandwidth shall be at least 500 kHz.	PASSED	5745 MHz = 16.50 MHz 5785 MHz = 16.50 MHz 5825 MHz = 16.50 MHz <i>Per Original Filing</i>
15.247(b)(3)	The maximum peak output power of the intentional radiator shall not exceed 1 watt.	PASSED	5745 MHz = 19.61 dBm = 91.40 mW 5785 MHz = 19.71 dBm = 93.53 mW 5825 MHz = 19.91 dBm = 97.94 mW
15.247(b)(5)	The intentional radiator shall be operated in a manner that ensures that the public is not exposed to radio frequency energy levels in excess of the FCC guidelines per Section 1.1307(b)(1).	PASSED	Refer to MPE Calculations Exhibit
15.247(c)	In any 100 kHz bandwidth outside the frequency band in which the spread spectrum intentional radiator is operating, the radio frequency power that is produced by the intentional radiator shall be at least 20 dB below that in the 100 kHz bandwidth within the band that contains the highest level of the desired power.	PASSED	See Data Sheets
15.247(c)	Radiated emissions, which fall in the restricted bands, as defined in Sec. 15.205(a), must also comply with the radiated emission limits specified in Sec. 15.209(a). All others must be < -20dBc.	PASSED	See Data Sheets
15.247(d)	The peak power spectral density conducted from the intentional radiator to the antenna shall not be greater than 8 dBm in any 3 kHz band during any time interval of continuous transmission.	PASSED	5745 MHz = -5.83 dB 5785 MHz = -6.67 dB 5825 MHz = -7.83 dB <i>Per Original Filing</i>
15.207	AC Conducted Emissions	PASSED	<i>See Original Filing</i>
15.209	Radiated Emissions (30-1000 MHz)	PASSED	<i>See Original Filing</i>



2.0 Summary of Test Results (Continued)

802.11a Mode (5745-5825 MHz) Chain B

EMISSIONS STANDARD

FCC Part 15 Section	Description	Results	Comments
15.247(a)(2)	The minimum 6dB bandwidth shall be at least 500 kHz.	PASSED	5745 MHz = 16.42 MHz 5785 MHz = 16.50 MHz 5825 MHz = 16.33 MHz <i>Per Original Filing</i>
15.247(b)(3)	The maximum peak output power of the intentional radiator shall not exceed 1 watt.	PASSED	5745 MHz = 20.21 dBm = 104.94 mW 5785 MHz = 20.31 dBm = 107.39 mW 5825 MHz = 20.31 dBm = 107.39 mW
15.247(b)(5)	The intentional radiator shall be operated in a manner that ensures that the public is not exposed to radio frequency energy levels in excess of the FCC guidelines per Section 1.1307(b)(1).	PASSED	Refer to MPE Calculations Exhibit
15.247(c)	In any 100 kHz bandwidth outside the frequency band in which the spread spectrum intentional radiator is operating, the radio frequency power that is produced by the intentional radiator shall be at least 20 dB below that in the 100 kHz bandwidth within the band that contains the highest level of the desired power.	PASSED	See Data Sheets
15.247(c)	Radiated emissions, which fall in the restricted bands, as defined in Sec. 15.205(a), must also comply with the radiated emission limits specified in Sec. 15.209(a). All others must be < -20dBc.	PASSED	See Data Sheets
15.247(d)	The peak power spectral density conducted from the intentional radiator to the antenna shall not be greater than 8 dBm in any 3 kHz band during any time interval of continuous transmission.	PASSED	5745 MHz = -4.00 dB 5785 MHz = -3.83 dB 5825 MHz = -6.17 dB <i>Per Original Filing</i>
15.207	AC Conducted Emissions	PASSED	<i>See Original Filing</i>
15.209	Radiated Emissions (30-1000 MHz)	PASSED	<i>See Original Filing</i>



2.0 Summary of Test Results (Continued)

802.11b Mode (2400-2483.5 MHz) Chain A

EMISSIONS STANDARD

FCC Part 15 Section	Description	Results	Comments
15.247(a)(2)	The minimum 6dB bandwidth shall be at least 500 kHz.	PASSED	2412 MHz = 12.58 MHz 2437 MHz = 12.67 MHz 2462 MHz = 12.67 MHz <i>Per Original Filing</i>
15.247(b)(3)	The maximum peak output power of the intentional radiator shall not exceed 1 watt.	PASSED	2412 MHz = 19.07 dBm = 80.68 mW 2437 MHz = 19.24 dBm = 83.90 mW 2462 MHz = 20.03 dBm = 100.64 mW
15.247(b)(5)	The intentional radiator shall be operated in a manner that ensures that the public is not exposed to radio frequency energy levels in excess of the FCC guidelines per Section 1.1307(b)(1).	PASSED	Refer to MPE Calculations Exhibit
15.247(c)	In any 100 kHz bandwidth outside the frequency band in which the spread spectrum intentional radiator is operating, the radio frequency power that is produced by the intentional radiator shall be at least 20 dB below that in the 100 kHz bandwidth within the band that contains the highest level of the desired power.	PASSED	See Data Sheets
15.247(c)	Radiated emissions, which fall in the restricted bands, as defined in Sec. 15.205(a), must also comply with the radiated emission limits specified in Sec. 15.209(a). All others must be < -20dBc.	PASSED	See Data Sheets
15.247(d)	The peak power spectral density conducted from the intentional radiator to the antenna shall not be greater than 8 dBm in any 3 kHz band during any time interval of continuous transmission.	PASSED	2412 MHz = -9.00 dB 2437 MHz = -9.00 dB 2462 MHz = -8.67 dB <i>Per Original Filing</i>
15.207	AC Conducted Emissions	PASSED	<i>See Original Filing</i>
15.209	Radiated Emissions (30-1000 MHz)	PASSED	<i>See Original Filing</i>



2.0 Summary of Test Results (Continued)

802.11b Mode (2400-2483.5 MHz) Chain B

EMISSIONS STANDARD

FCC Part 15 Section	Description	Results	Comments
15.247(a)(2)	The minimum 6dB bandwidth shall be at least 500 kHz.	PASSED	2412 MHz = 12.08 MHz 2437 MHz = 12.17 MHz 2462 MHz = 13.00 MHz <i>Per Original Filing</i>
15.247(b)(3)	The maximum peak output power of the intentional radiator shall not exceed 1 watt.	PASSED	2412 MHz = 18.73 dBm = 74.61 mW 2437 MHz = 18.88 dBm = 77.23 mW 2462 MHz = 19.94 dBm = 98.58 mW
15.247(b)(5)	The intentional radiator shall be operated in a manner that ensures that the public is not exposed to radio frequency energy levels in excess of the FCC guidelines per Section 1.1307(b)(1).	PASSED	Refer to MPE Calculations Exhibit
15.247(c)	In any 100 kHz bandwidth outside the frequency band in which the spread spectrum intentional radiator is operating, the radio frequency power that is produced by the intentional radiator shall be at least 20 dB below that in the 100 kHz bandwidth within the band that contains the highest level of the desired power.	PASSED	See Data Sheets
15.247(c)	Radiated emissions, which fall in the restricted bands, as defined in Sec. 15.205(a), must also comply with the radiated emission limits specified in Sec. 15.209(a). All others must be < -20dBc.	PASSED	See Data Sheets
15.247(d)	The peak power spectral density conducted from the intentional radiator to the antenna shall not be greater than 8 dBm in any 3 kHz band during any time interval of continuous transmission.	PASSED	2412 MHz = -7.67 dB 2437 MHz = -6.50 dB 2462 MHz = -6.67 dB <i>Per Original Filing</i>
15.207	AC Conducted Emissions	PASSED	<i>See Original Filing</i>
15.209	Radiated Emissions (30-1000 MHz)	PASSED	<i>See Original Filing</i>



2.0 Summary of Test Results (Continued)

802.11g Mode (2400-2483.5 MHz) Chain A

EMISSIONS STANDARD

FCC Part 15 Section	Description	Results	Comments
15.247(a)(2)	The minimum 6dB bandwidth shall be at least 500 kHz.	PASSED	2412 MHz = 16.50 MHz 2437 MHz = 16.50 MHz 2462 MHz = 16.50 MHz <i>Per Original Filing</i>
15.247(b)(3)	The maximum peak output power of the intentional radiator shall not exceed 1 watt.	PASSED	2412 MHz = 23.80 dBm = 239.86 mW 2437 MHz = 23.83 dBm = 241.52 mW 2462 MHz = 23.48 dBm = 222.82 mW
15.247(b)(5)	The intentional radiator shall be operated in a manner that ensures that the public is not exposed to radio frequency energy levels in excess of the FCC guidelines per Section 1.1307(b)(1).	PASSED	Refer to MPE Calculations Exhibit
15.247(c)	In any 100 kHz bandwidth outside the frequency band in which the spread spectrum intentional radiator is operating, the radio frequency power that is produced by the intentional radiator shall be at least 20 dB below that in the 100 kHz bandwidth within the band that contains the highest level of the desired power.	PASSED	See Data Sheets
15.247(c)	Radiated emissions, which fall in the restricted bands, as defined in Sec. 15.205(a), must also comply with the radiated emission limits specified in Sec. 15.209(a). All others must be < -20dBc.	PASSED	See Data Sheets
15.247(d)	The peak power spectral density conducted from the intentional radiator to the antenna shall not be greater than 8 dBm in any 3 kHz band during any time interval of continuous transmission.	PASSED	2412 MHz = -6.33 dB 2437 MHz = -7.17 dB 2462 MHz = -8.67 dB <i>Per Original Filing</i>
15.207	AC Conducted Emissions	PASSED	<i>See Original Filing</i>
15.209	Radiated Emissions (30-1000 MHz)	PASSED	<i>See Original Filing</i>



2.0 Summary of Test Results (Continued)

802.11g Mode (2400-2483.5 MHz) Chain B

EMISSIONS STANDARD			
FCC Part 15 Section	Description	Results	Comments
15.247(a)(2)	The minimum 6dB bandwidth shall be at least 500 kHz.	PASSED	2412 MHz = 16.42 MHz 2437 MHz = 16.50 MHz 2462 MHz = 16.50 MHz <i>Per Original Filing</i>
15.247(b)(3)	The maximum peak output power of the intentional radiator shall not exceed 1 watt.	PASSED	2412 MHz = 23.54 dBm = 225.92 mW 2437 MHz = 23.63 dBm = 230.65 mW 2462 MHz = 23.52 dBm = 224.88 mW
15.247(b)(5)	The intentional radiator shall be operated in a manner that ensures that the public is not exposed to radio frequency energy levels in excess of the FCC guidelines per Section 1.1307(b)(1).	PASSED	Refer to MPE Calculations Exhibit
15.247(c)	In any 100 kHz bandwidth outside the frequency band in which the spread spectrum intentional radiator is operating, the radio frequency power that is produced by the intentional radiator shall be at least 20 dB below that in the 100 kHz bandwidth within the band that contains the highest level of the desired power.	PASSED	See Data Sheets
15.247(c)	Radiated emissions, which fall in the restricted bands, as defined in Sec. 15.205(a), must also comply with the radiated emission limits specified in Sec. 15.209(a). All others must be < -20dBc.	PASSED	See Data Sheets
15.247(d)	The peak power spectral density conducted from the intentional radiator to the antenna shall not be greater than 8 dBm in any 3 kHz band during any time interval of continuous transmission.	PASSED	2412 MHz = -8.67 dB 2437 MHz = -6.67 dB 2462 MHz = -8.00 dB <i>Per Original Filing</i>
15.207	AC Conducted Emissions	PASSED	<i>See Original Filing</i>
15.209	Radiated Emissions (30-1000 MHz)	PASSED	<i>See Original Filing</i>



2.0 Summary of Test Results (Continued)

802.11n Mode 20MHz Wide (2400-2483.5 MHz) Chain A

EMISSIONS STANDARD			
FCC Part 15 Section	Description	Results	Comments
15.247(a)(2)	The minimum 6dB bandwidth shall be at least 500 kHz.	PASSED	2412 MHz = 17.67 MHz 2437 MHz = 17.67 MHz 2462 MHz = 17.83 MHz <i>Per Original Filing</i>
15.247(b)(3)	The maximum peak output power of the intentional radiator shall not exceed 1 watt.	PASSED	2412 MHz = 23.55 dBm = 226.44 mW 2437 MHz = 23.37 dBm = 217.25 mW 2462 MHz = 23.28 dBm = 212.79 mW
15.247(b)(5)	The intentional radiator shall be operated in a manner that ensures that the public is not exposed to radio frequency energy levels in excess of the FCC guidelines per Section 1.1307(b)(1).	PASSED	Refer to MPE Calculations Exhibit
15.247(c)	In any 100 kHz bandwidth outside the frequency band in which the spread spectrum intentional radiator is operating, the radio frequency power that is produced by the intentional radiator shall be at least 20 dB below that in the 100 kHz bandwidth within the band that contains the highest level of the desired power.	PASSED	See Data Sheets
15.247(c)	Radiated emissions, which fall in the restricted bands, as defined in Sec. 15.205(a), must also comply with the radiated emission limits specified in Sec. 15.209(a). All others must be < -20dBc.	PASSED	See Data Sheets
15.247(d)	The peak power spectral density conducted from the intentional radiator to the antenna shall not be greater than 8 dBm in any 3 kHz band during any time interval of continuous transmission.	PASSED	2412 MHz = -3.00 dB 2437 MHz = -2.67 dB 2462 MHz = -3.33 dB <i>Per Original Filing</i>
15.207	AC Conducted Emissions	PASSED	<i>See Original Filing</i>
15.209	Radiated Emissions (30-1000 MHz)	PASSED	<i>See Original Filing</i>



2.0 Summary of Test Results (Continued)

802.11n Mode 20MHz Wide (2400-2483.5 MHz) Chain B

EMISSIONS STANDARD			
FCC Part 15 Section	Description	Results	Comments
15.247(a)(2)	The minimum 6dB bandwidth shall be at least 500 kHz.	PASSED	2412 MHz = 17.67 MHz 2437 MHz = 17.67 MHz 2462 MHz = 17.75 MHz <i>Per Original Filing</i>
15.247(b)(3)	The maximum peak output power of the intentional radiator shall not exceed 1 watt.	PASSED	2412 MHz = 23.27 dBm = 212.30 mW 2437 MHz = 23.39 dBm = 218.25 mW 2462 MHz = 23.19 dBm = 208.43 mW
15.247(b)(5)	The intentional radiator shall be operated in a manner that ensures that the public is not exposed to radio frequency energy levels in excess of the FCC guidelines per Section 1.1307(b)(1).	PASSED	Refer to MPE Calculations Exhibit
15.247(c)	In any 100 kHz bandwidth outside the frequency band in which the spread spectrum intentional radiator is operating, the radio frequency power that is produced by the intentional radiator shall be at least 20 dB below that in the 100 kHz bandwidth within the band that contains the highest level of the desired power.	PASSED	See Data Sheets
15.247(c)	Radiated emissions, which fall in the restricted bands, as defined in Sec. 15.205(a), must also comply with the radiated emission limits specified in Sec. 15.209(a). All others must be < -20dBc.	PASSED	See Data Sheets
15.247(d)	The peak power spectral density conducted from the intentional radiator to the antenna shall not be greater than 8 dBm in any 3 kHz band during any time interval of continuous transmission.	PASSED	2412 MHz = -8.50 dB 2437 MHz = -8.33 dB 2462 MHz = -8.17 dB <i>Per Original Filing</i>
15.207	AC Conducted Emissions	PASSED	<i>See Original Filing</i>
15.209	Radiated Emissions (30-1000 MHz)	PASSED	<i>See Original Filing</i>



2.0 Summary of Test Results (Continued)

802.11n Mode 20MHz Wide (5745-5825 MHz) Chain A

EMISSIONS STANDARD

FCC Part 15 Section	Description	Results	Comments
15.247(a)(2)	The minimum 6dB bandwidth shall be at least 500 kHz.	PASSED	5745 MHz = 17.50 MHz 5785 MHz = 17.58 MHz 5825 MHz = 17.50 MHz <i>Per Original Filing</i>
15.247(b)(3)	The maximum peak output power of the intentional radiator shall not exceed 1 watt.	PASSED	5745 MHz = 20.11 dBm = 102.56 mW 5785 MHz = 20.91 dBm = 123.30 mW 5825 MHz = 20.41 dBm = 109.89 mW
15.247(b)(5)	The intentional radiator shall be operated in a manner that ensures that the public is not exposed to radio frequency energy levels in excess of the FCC guidelines per Section 1.1307(b)(1).	PASSED	Refer to MPE Calculations Exhibit
15.247(c)	In any 100 kHz bandwidth outside the frequency band in which the spread spectrum intentional radiator is operating, the radio frequency power that is produced by the intentional radiator shall be at least 20 dB below that in the 100 kHz bandwidth within the band that contains the highest level of the desired power.	PASSED	See Data Sheets
15.247(c)	Radiated emissions, which fall in the restricted bands, as defined in Sec. 15.205(a), must also comply with the radiated emission limits specified in Sec. 15.209(a). All others must be < -20dBc.	PASSED	See Data Sheets
15.247(d)	The peak power spectral density conducted from the intentional radiator to the antenna shall not be greater than 8 dBm in any 3 kHz band during any time interval of continuous transmission.	PASSED	5745 MHz = -3.83 dB 5785 MHz = -4.33 dB 5825 MHz = -6.17 dB <i>Per Original Filing</i>
15.207	AC Conducted Emissions	PASSED	<i>See Original Filing</i>
15.209	Radiated Emissions (30-1000 MHz)	PASSED	<i>See Original Filing</i>



2.0 Summary of Test Results (Continued)

802.11n Mode 20MHz Wide (5745-5825 MHz) Chain B

EMISSIONS STANDARD

FCC Part 15 Section	Description	Results	Comments
15.247(a)(2)	The minimum 6dB bandwidth shall be at least 500 kHz.	PASSED	5745 MHz = 17.67 MHz 5785 MHz = 17.58 MHz 5825 MHz = 17.75 MHz <i>Per Original Filing</i>
15.247(b)(3)	The maximum peak output power of the intentional radiator shall not exceed 1 watt.	PASSED	5745 MHz = 20.21 dBm = 104.94 mW 5785 MHz = 20.61 dBm = 115.07 mW 5825 MHz = 20.31 dBm = 107.39 mW
15.247(b)(5)	The intentional radiator shall be operated in a manner that ensures that the public is not exposed to radio frequency energy levels in excess of the FCC guidelines per Section 1.1307(b)(1).	PASSED	Refer to MPE Calculations Exhibit
15.247(c)	In any 100 kHz bandwidth outside the frequency band in which the spread spectrum intentional radiator is operating, the radio frequency power that is produced by the intentional radiator shall be at least 20 dB below that in the 100 kHz bandwidth within the band that contains the highest level of the desired power.	PASSED	See Data Sheets
15.247(c)	Radiated emissions, which fall in the restricted bands, as defined in Sec. 15.205(a), must also comply with the radiated emission limits specified in Sec. 15.209(a). All others must be < -20dBc.	PASSED	See Data Sheets
15.247(d)	The peak power spectral density conducted from the intentional radiator to the antenna shall not be greater than 8 dBm in any 3 kHz band during any time interval of continuous transmission.	PASSED	5745 MHz = -9.17 dB 5785 MHz = -8.83 dB 5825 MHz = -9.17 dB <i>Per Original Filing</i>
15.207	AC Conducted Emissions	PASSED	<i>See Original Filing</i>
15.209	Radiated Emissions (30-1000 MHz)	PASSED	<i>See Original Filing</i>



2.0 Summary of Test Results (Continued)

802.11n Mode 40MHz Wide (5745-5825 MHz) Chain A

EMISSIONS STANDARD

FCC Part 15 Section	Description	Results	Comments
15.247(a)(2)	The minimum 6dB bandwidth shall be at least 500 kHz.	PASSED	5755 MHz = 35.50 MHz 5795 MHz = 35.70 MHz <i>Per Original Filing</i>
15.247(b)(3)	The maximum peak output power of the intentional radiator shall not exceed 1 watt.	PASSED	5755 MHz = 18.51 dBm = 70.95 mW 5795 MHz = 18.11 dBm = 64.70 mW
15.247(b)(5)	The intentional radiator shall be operated in a manner that ensures that the public is not exposed to radio frequency energy levels in excess of the FCC guidelines per Section 1.1307(b)(1).	PASSED	Refer to MPE Calculations Exhibit
15.247(c)	In any 100 kHz bandwidth outside the frequency band in which the spread spectrum intentional radiator is operating, the radio frequency power that is produced by the intentional radiator shall be at least 20 dB below that in the 100 kHz bandwidth within the band that contains the highest level of the desired power.	PASSED	See Data Sheets
15.247(c)	Radiated emissions, which fall in the restricted bands, as defined in Sec. 15.205(a), must also comply with the radiated emission limits specified in Sec. 15.209(a). All others must be < -20dBc.	PASSED	See Data Sheets
15.247(d)	The peak power spectral density conducted from the intentional radiator to the antenna shall not be greater than 8 dBm in any 3 kHz band during any time interval of continuous transmission.	PASSED	5755 MHz = -3.00 dB 5795 MHz = -6.83 dB <i>Per Original Filing</i>
15.207	AC Conducted Emissions	PASSED	<i>See Original Filing</i>
15.209	Radiated Emissions (30-1000 MHz)	PASSED	<i>See Original Filing</i>

2.0 Summary of Test Results (Continued)

802.11n Mode 40MHz Wide (5745-5825 MHz) Chain B

EMISSIONS STANDARD

FCC Part 15 Section	Description	Results	Comments
15.247(a)(2)	The minimum 6dB bandwidth shall be at least 500 kHz.	PASSED	5755 MHz = 35.50 MHz 5795 MHz = 35.50 MHz <i>Per Original Filing</i>
15.247(b)(3)	The maximum peak output power of the intentional radiator shall not exceed 1 watt.	PASSED	5755 MHz = 18.41 dBm = 69.33 mW 5795 MHz = 18.21 dBm = 66.21 mW
15.247(b)(5)	The intentional radiator shall be operated in a manner that ensures that the public is not exposed to radio frequency energy levels in excess of the FCC guidelines per Section 1.1307(b)(1).	PASSED	Refer to MPE Calculations Exhibit
15.247(c)	In any 100 kHz bandwidth outside the frequency band in which the spread spectrum intentional radiator is operating, the radio frequency power that is produced by the intentional radiator shall be at least 20 dB below that in the 100 kHz bandwidth within the band that contains the highest level of the desired power.	PASSED	See Data Sheets
15.247(c)	Radiated emissions, which fall in the restricted bands, as defined in Sec. 15.205(a), must also comply with the radiated emission limits specified in Sec. 15.209(a). All others must be < -20dBc.	PASSED	See Data Sheets
15.247(d)	The peak power spectral density conducted from the intentional radiator to the antenna shall not be greater than 8 dBm in any 3 kHz band during any time interval of continuous transmission.	PASSED	5755 MHz = -12.33 dB 5795 MHz = -13.17 dB <i>Per Original Filing</i>
15.207	AC Conducted Emissions	PASSED	<i>See Original Filing</i>
15.209	Radiated Emissions (30-1000 MHz)	PASSED	<i>See Original Filing</i>

ANALYSIS AND CONCLUSIONS

Based upon the measurement results we find that this equipment is within the limits of the global standards listed on the cover page of this test report. All results are based on a test of one sample. If any significant changes are made to the unit, the changes shall be evaluated and a retest may be required.

Approval Signatories

Test and Report Completed By:

Johnny Candelas 03/30/07
Test Technician **Date:**
Aegis Labs, Inc.

Report Approved By:

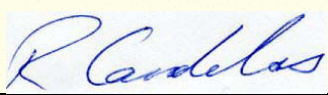
Rick Candelas 03/30/07
Quality Assurance Manager **Date:**
Aegis Labs, Inc.



3.0 ADMINISTRATIVE DATA AND TEST DESCRIPTION

DEVICE TESTED:	ITE Type: Intel Wireless WiFi Link 4965AGN Model Number(s): 4965AGN Serial Number: 0013E804612B FCC ID: PD94965AGN
DATE EUT RECEIVED:	March 19 th , 2007
TEST DATE(S):	March 20 th – 30 th , 2007
ORIGIN OF TEST SAMPLE(S):	Production
EQUIPMENT CLASS:	EUT tested as CLASS B device
RESPONSIBLE PARTY:	Intel Corporation 2111 NE 25 th Avenue Hillsboro, Oregon 97124
CLIENT CONTACT:	Mr. Robert Paxman
MANUFACTURER:	Intel Corporation
TEST LOCATION:	Aegis Labs, Inc. 32231 Trabuco Creek Road Trabuco Canyon, CA 92678 Open Area Test Site #1
ACCREDITATION CERTIFICATE(S):	A2LA Certificate Number: 1111.01, Valid through February 28, 2008
PURPOSE OF TEST:	To demonstrate compliance with the standards as described in Sections 1.0 & 2.0 of this report.
UNCERTAINTY BUDGET:	Proficiency Testing and Uncertainty Calculations for all tests indicated in this report have been conducted in accordance with ISO 17025: 2005 requirements Section 5.4.6, and 5.9. Uncertainty Budgets and Proficiency Test results available upon request.
STATEMENT OF CALIBRATION:	All accredited equipment calibrations were performed by Liberty Labs, Inc. and World Cal. with typical calibration uncertainty estimates derived from ISO Guide to the determination of uncertainties with a Coverage Factor of k=2 for 95% level of confidence.

4.0 DESCRIPTION OF EUT CONFIGURATION

4.1 EUT Description

Equipment Under Test (EUT)	
Trade Name:	Intel Wireless WiFi Link 4965AGN
Model Number:	4965AGN
Frequency Range:	802.11a = 5745 – 5825 MHz 802.11b/g = 2412 – 2462MHz 802.11n = 2412 – 2462MHz & 5745 – 5825 MHz
Type of Transmission:	Direct Sequence Spread Spectrum
Transfer Rate:	1/5.5/11 Mbps for 802.11b mode 6/36/54 Mbps for 802.11g and 802.11a modes Up to 300 Mbps for 802.11n mode
Number of Channels:	802.11a mode (5725-5850 MHz) = 5 802.11b mode (2400-2483.5 MHz) = 11 802.11g mode (2400-2483.5 MHz) = 11 802.11n mode (5725-5850 MHz) = 5 802.11n mode (2400-2483.5 MHz) = 11
Modulation Type:	DBPSK, DQPSK, CCK, OFDM
Antenna Type:	Monopole
Antenna Gain (See Note 2):	1.62 dBi @ 5 GHz / 0.74 dBi @ 2.4 GHz
Transmit Output Power:	Please see Appendix A (Data Sheets) for actual output power.
Power Supply:	3.3VDC from computer MPCPI slot.
Number of External Test Ports Exercised:	3 Antenna Ports

The Intel Wireless WiFi Link 4965AGN is an embedded 802.11a/b/g/n network adapter operating in the 2.4 GHz and 5 GHz spectrum. The EUT is based on the Mini Card form factor designed to meet the space and size requirements for thin and light notebook PCs. It is capable of a data rate of up to 300 Mbps.

NOTE 1: For a more detailed description, please refer to the manufacture’s specifications or User’s Manual.

NOTE 2: The EUT was tested with a set of Sony IRX-3980 Antennas. (Refer to the antenna specifications exhibits).

4.2 EUT Configuration

The EUT was tested installed in the Mini PCI-E slot of the host computer as a modular device using a PCI extender board to extend the EUT outside the computer chassis. The EUT was then connected to a set of antennas via its Chain A, B, & C antenna ports. Data for a set of Sony IRX-3980 Antennas can be found in Appendix A (Data Sheets)

The low, middle, and high channels were tested in 802.11a, b, g, & n modes. Also, the EUT was tested once transmitting from Chain A antenna port and once transmitting from Chain B antenna port. The EUT was placed in either continuous transmit or continuous receive mode by a program provided by the manufacturer (*CRTU Version 4.1.14.0000*).

4.3 List of EUT, Sub-Assemblies and Host Equipment

Equipment Under Test			
Manufacturer	Equipment Name	Model or Part Number	Serial Number
Intel Corporation	Intel Wireless WiFi Link 4965AGN	4965AGN	0013E804612B

EUT Sub Assemblies			
Manufacturer	Equipment Name	Model or Part Number	Serial Number
Hitachi Cable, Ltd	Chain A (Tx) Antenna	1-754-517	N/A
Hitachi Cable, Ltd	Chain B (Tx) Antenna	1-754-518	N/A
Hitachi Cable, Ltd	Chain C (Rx) Antenna	1-754-519	N/A

HOST EQUIPMENT LIST			
Manufacturer	Equipment Name	Model or Part Number	Serial Number
GST	Host Computer	GST-8000	G0400295337-015
Sony	Monitor	CPD-200ES	0742818
Logitech	Keyboard	Y-BF37	MCT25200581
Logitech	Mouse	M-BJ58	PMA32715049

NOTE: All the power cords of the above support equipment are standard and non-shielded.

4.4 I/O Cabling Diagram and Description

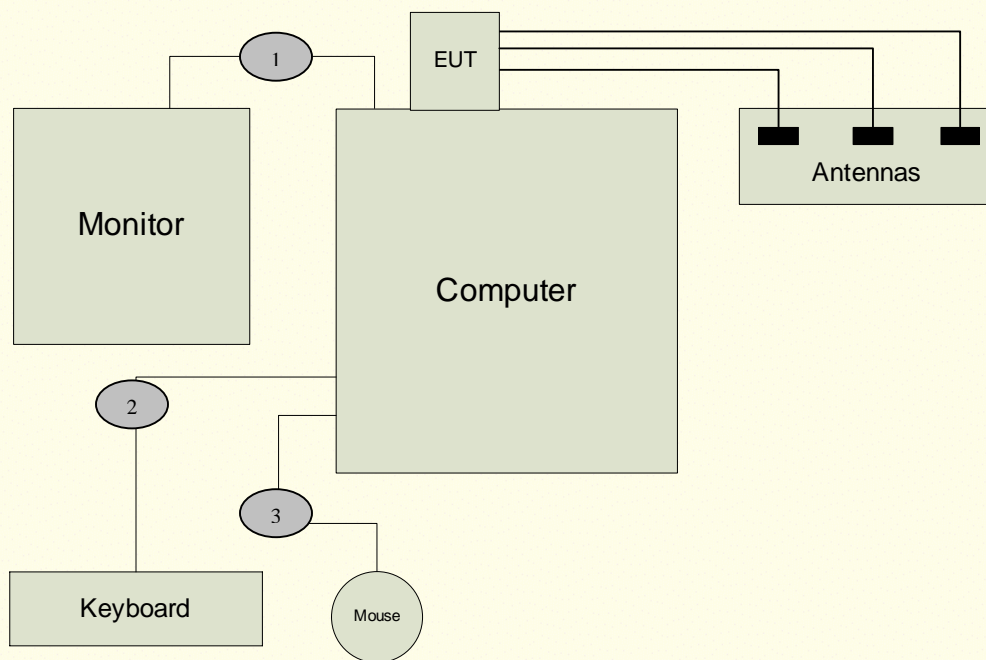

Signal Line Cable Description

Cable	Length	Construction	Source Connector	Destination Connector	Bundled Length	Ferrite Attached	Note
1	1.5m	Round, Braid & Foil Shielded	Host Computer: Metallic DB-15	Monitor: Hardwired	N/A	N/A	N/A
2	1.5m	Round, Braid & Foil Shielded	Host Computer: Metallic 8-pin Mini DIN	Keyboard: Hardwired	N/A	N/A	N/A
3	1.5m	Round, Braid & Foil Shielded	Host Computer: Metallic 8-pin Mini DIN	Mouse: Hardwired	N/A	N/A	N/A



4.5 EMC Test Hardware and Software Measurement Equipment

TEST EQUIPMENT LIST - Emissions

Equipment Name	Manufacturer	Model Number	Serial Number	Calibration Due Date	Maintenance Calibration Cycle
Spectrum Analyzer	Agilent	8565EC	3946A00245	07/24/07	1 Year
Antenna - Horn	EMCO	3115	2230	05/15/07	1 Year
Preamp	Aegis	AEGIS-OATS-1-18	001	07/28/07	1 Year
28 Foot Coax	Semflex	S1L29BFS1348	608	07/26/07	1 Year
2.4 GHz Notch Filter	Micro-Tronics	BRM50702-02	003	04/21/07	2 Years
5.725-5.850 GHz Notch Filter	Microwave Circuits	N0257881	3173-01	04/21/07	2 Years
Power Meter	Anritsu	ML2487A	6K00001785	05/30/07	1 Year
Wide Bandwidth Sensor	Anritsu	MA2491A	31193	05/30/07	1 Year
12dB Attenuator	Narda	4779-12	203	06/09/07	2 Years
Temperature/Humidity Monitor	Dickson	TH550	7255185	03/24/08	2 Years

5.0 CONDITIONS DURING EMISSIONS MEASUREMENTS

5.1 General

All measurements were made according to the procedures defined in or referred to by the standard listed on the cover page of this report. The measurements were made in the operating mode producing the largest emissions consistent with normal operation and connected to the minimum configuration of auxiliary devices.

5.2 Conducted Emissions Test Setup

The following was the test configuration.

EUT signal cables that hung closer than 40 cm to the horizontal metal ground plane were folded back and forth forming a bundle 30 cm to 40 cm long. The power cord of the EUT was also bundled in the center and plugged into one of the artificial mains network (AMN). All peripheral equipment was powered from a second AMN via a multiple outlet strip placed at a distance on 10cm from each other. The AMN and ISN were positioned 80cm from the EUT. Signal cables that were not connected to an AE were terminated using the correct termination. If applicable, the current probe was placed at 0.1 m from the ISN.

Peak, quasi-peak and/or average detectors were used for testing performed between 150 kHz and 30 MHz. A swept frequency scan was performed for both Line 1 and Line 2. The six highest readings were compared against the limit and recorded in the data sheet along with a snapshot image of the sweep scan. The graphical scans in Appendix A only reflect peak readings while the tabulated data sheets reflect peak, average, and/or quasi-peak measurements.

Climatic Conditions:

The EUT was tested within its intended operating and climatic conditions.

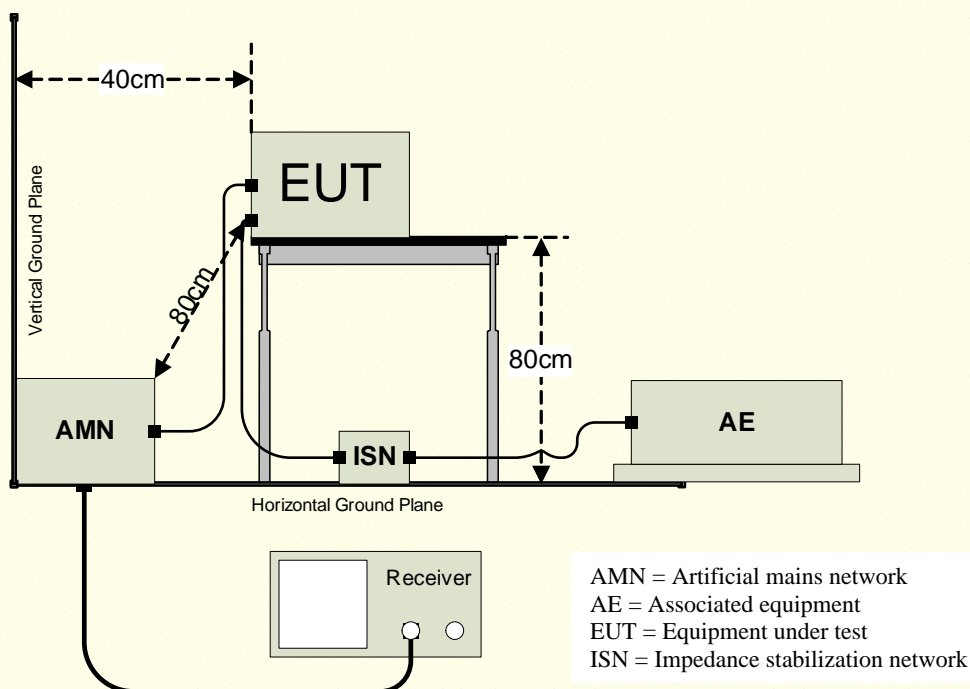

5.3 Radiated Emissions Test Setup

The Open Area Test Site (OATS) was used for radiated emission testing. The receiving (Rx) antenna(s) was placed 10m from the nearest side of the EUT facing the Rx antenna. The EUT (if floor-standing) was placed directly on the flush-mounted 360 degree rotating turntable. The EUT (if table-top) was placed directly on an 80cm high non-metallic table, and the table was placed on the rotating turntable. During the initial EMI scan, all the suspect frequencies, i.e.; harmonics, broadband signals were checked with the Rx broadband antennas in both vertical and horizontal polarities. The biconical Rx, log periodic Rx, and horn Rx antennas were used from 30MHz – 299.99MHz, 300MHz – 1000MHz, and 1GHz – 18GHz respectively.

Upon completion of all harmonic and broadband measurements, the balance of any remaining frequencies was checked between 30MHz – 18GHz. Any signals appearing within 20 dB of the classification limit was measured. Each signal was maximized by first rotating the turntable at least 360 degrees and recording the azimuth in the data sheet. Lastly, the Rx antenna was raised and/or lowered to maximize the signal elevation. If the measured signal was obtained using the peak detector and that signal appeared within 3 dB of the regulatory limit line, then the same signal was re-measured using the quasi-peak detector on the EMI receiver. Both meter readings if necessary were recorded on the data sheet.

Climatic Conditions:

The EUT was tested within its intended operating and climatic conditions.

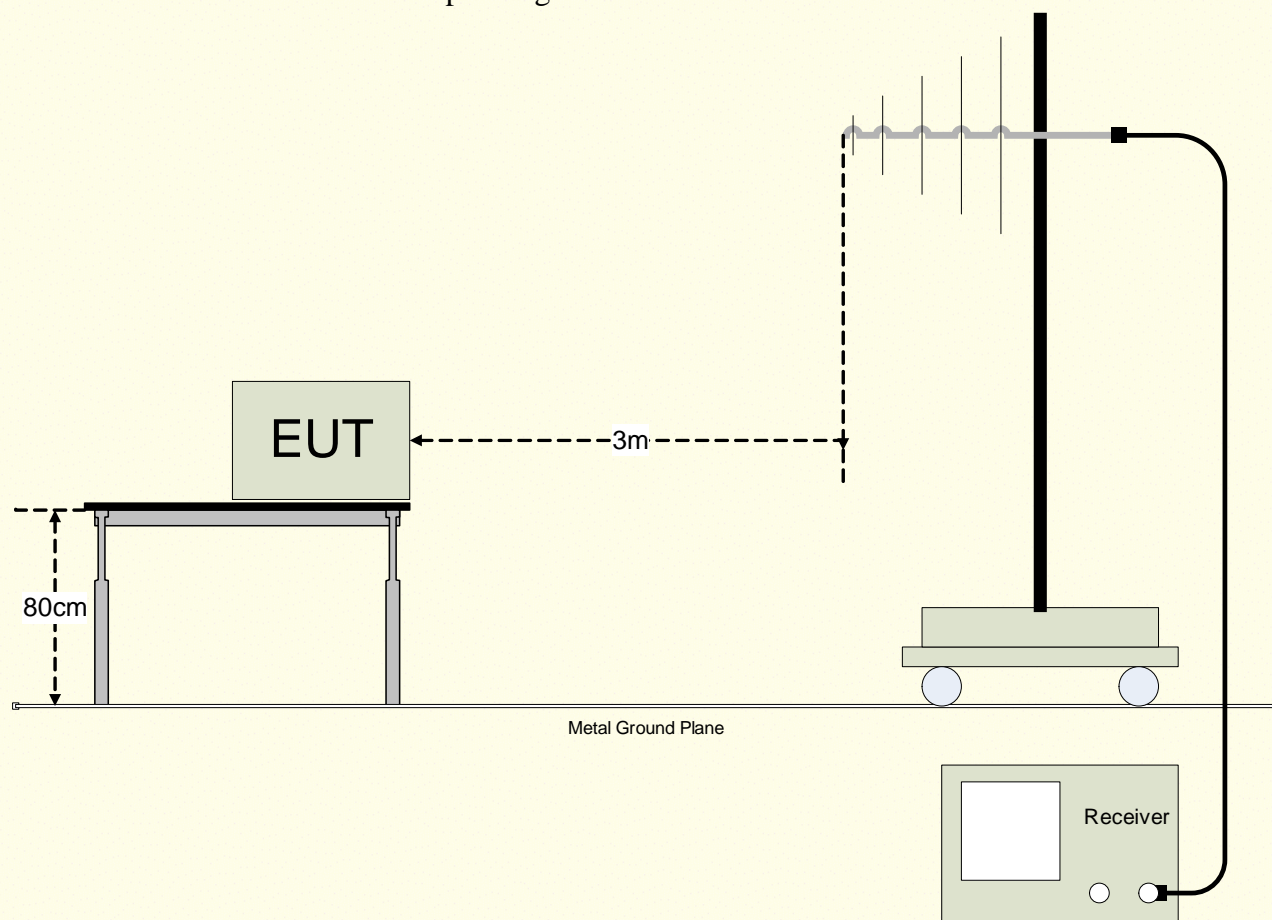



APPENDIX A

TEST DATA



RADIATED EMISSIONS TEST RESULTS

CLIENT:	Intel Corporation	DATE:	03/20/07
EUT:	Intel Wireless WiFi Link 4965AGN	PROJECT NUMBER:	INTEL-070320
MODEL NUMBER:	4965AGN	TEST ENGINEER:	BM/JC
SERIAL NUMBER:	0013E804612B	SITE #:	1
CONFIGURATION:	Tested installed in the host computer's mini PCI slot in 802.11a (5745-5825 MHz) mode with Sony IRX-3980 Antennas.	TEMPERATURE:	15 deg. C
		HUMIDITY:	52% RH
		TIME:	5:30 PM

Description:	Radiated RF Emissions (1 GHz – 18 GHz)
Results:	PASSED Horizontal and Vertical Antenna Polarizations Class B Limits
Note:	Radiated Emissions Measurements were performed on the EUT with power supply set at the following voltage and frequency. <ul style="list-style-type: none"> • 120VAC / 60 Hz.

Unwanted Spurious Emissions Limits			
Frequency (MHz)	Field Strength (uV/m)	Field Strength (dBuV/m) (Emissions in the restricted bands)	Field Strength (dBm/MHz) (Emissions outside the restricted bands)
Above 960	500	54.00 (Average) 74.00 (Peak)	< -20 dBc

Radiated Emissions Sample Calculations

$$\text{Corrected Meter Reading} = \text{Meter Reading} + F + C - D$$

Where, F = Antenna Factor

C = Cable Factor

G = Amplifier Gain

D = Distance Factor (if applicable)

Therefore, the equation for determining the Corrected Meter Reading Limit (CML) is:

$$\text{CML} = \text{Specification Limit} - F - C + D$$



Radiated Emissions Test Results (Continued)

*Fundamental Measurements in 802.11a mode (5745-5825 MHz)
Channels 149, 157, & 165
Continuous TX at Chain A Antenna port with Sony IRX-3980 Antennas
Aegis Labs, Inc. File #: INTEL-070320-02*

RADIATED EMISSIONS - Horizontal Antenna Polarization												
Freq. (MHz)	Meter Reading (dBuV)	Antenna Height (cm)	Azimuth (degrees)	Quasi pk or AVG (dBuV)		Distance Factor (dB)	Cable Factor (dB)	Ant. Factor (dB)	Corrected Reading (dBuV)	Limits (dBuV)	Diff (dB) +=FAIL	Comments
5745.00	65.17	100	225			9.54	3.15	35.25	94.03			Ch. 149
5745.00				51.33	A	9.54	3.15	35.25	80.19			
5785.00	64.17	100	225			9.54	3.17	35.26	93.05			Ch. 157
5785.00				50.17	A	9.54	3.17	35.26	79.05			
5825.00	74.00	100	225			9.54	3.18	35.27	102.90			Ch. 165
5825.00				59.17	A	9.54	3.18	35.27	88.07			

RADIATED EMISSIONS - Vertical Antenna Polarization												
Freq. (MHz)	Meter Reading (dBuV)	Antenna Height (cm)	Azimuth (degrees)	Quasi pk or AVG (dBuV)		Distance Factor (dB)	Cable Factor (dB)	Ant. Factor (dB)	Corrected Reading (dBuV)	Limits (dBuV)	Diff (dB) +=FAIL	Comments
5745.00	64.50	100	225			9.54	3.15	35.05	93.16			Ch. 149
5745.00				50.33	A	9.54	3.15	35.05	78.99			
5785.00	66.67	100	225			9.54	3.17	35.07	95.37			Ch. 157
5785.00				52.67	A	9.54	3.17	35.07	81.37			
5825.00	73.50	100	225			9.54	3.18	35.10	102.23			Ch. 165
5825.00				59.33	A	9.54	3.18	35.10	88.06			

NOTE: Fundamental signals measured at 1 meter and extrapolated to 3 meters to calculate the radiated band edge field strengths.



Radiated Emissions Test Results (Continued)

*Band Edge Field Strength Measurements in 802.11a mode (5745-5825 MHz)
 Channels 149 & 165
 Continuous TX at Chain A Antenna port with Sony IRX-3980 Antennas
 Aegis Labs, Inc. File #: INTEL-070320-02*

RADIATED EMISSIONS - Horizontal Antenna Polarization												
<i>Freq. (MHz)</i>	<i>Meter Reading (dBuV)</i>	<i>Antenna Height (cm)</i>	<i>Azimuth (degrees)</i>	<i>Quasi pk or AVG (dBuV)</i>	<i>Distance Factor (dB)</i>	<i>Cable Factor (dB)</i>	<i>Ant. Factor (dB)</i>	<i>Corrected Reading (dBuV)</i>	<i>Limits (dBuV)</i>	<i>Diff (dB) +=FAIL</i>	<i>Comments</i>	
5725.00	35.17	100	225		9.54	3.15	35.25	64.02	74.03	-10.01	Ch. 149	
5850.00	34.33	100	225		9.54	3.19	35.27	63.25	82.90	-19.66	Ch. 165	

RADIATED EMISSIONS - Vertical Antenna Polarization												
<i>Freq. (MHz)</i>	<i>Meter Reading (dBuV)</i>	<i>Antenna Height (cm)</i>	<i>Azimuth (degrees)</i>	<i>Quasi pk or AVG (dBuV)</i>	<i>Distance Factor (dB)</i>	<i>Cable Factor (dB)</i>	<i>Ant. Factor (dB)</i>	<i>Corrected Reading (dBuV)</i>	<i>Limits (dBuV)</i>	<i>Diff (dB) +=FAIL</i>	<i>Comments</i>	
5725.00	31.50	100	225		9.54	3.15	35.04	60.14	73.16	-13.02	Ch. 149	
5850.00	33.83	100	225		9.54	3.19	35.11	62.59	82.23	-19.65	Ch. 165	

NOTE: The “Band Edge Field Strength” was calculated using the “Radiated Fundamental” measurements.

Radiated Emissions Test Results (Continued)

Plots Showing Out-Of-Band Emissions (Peak RBW=VBW=1MHz)

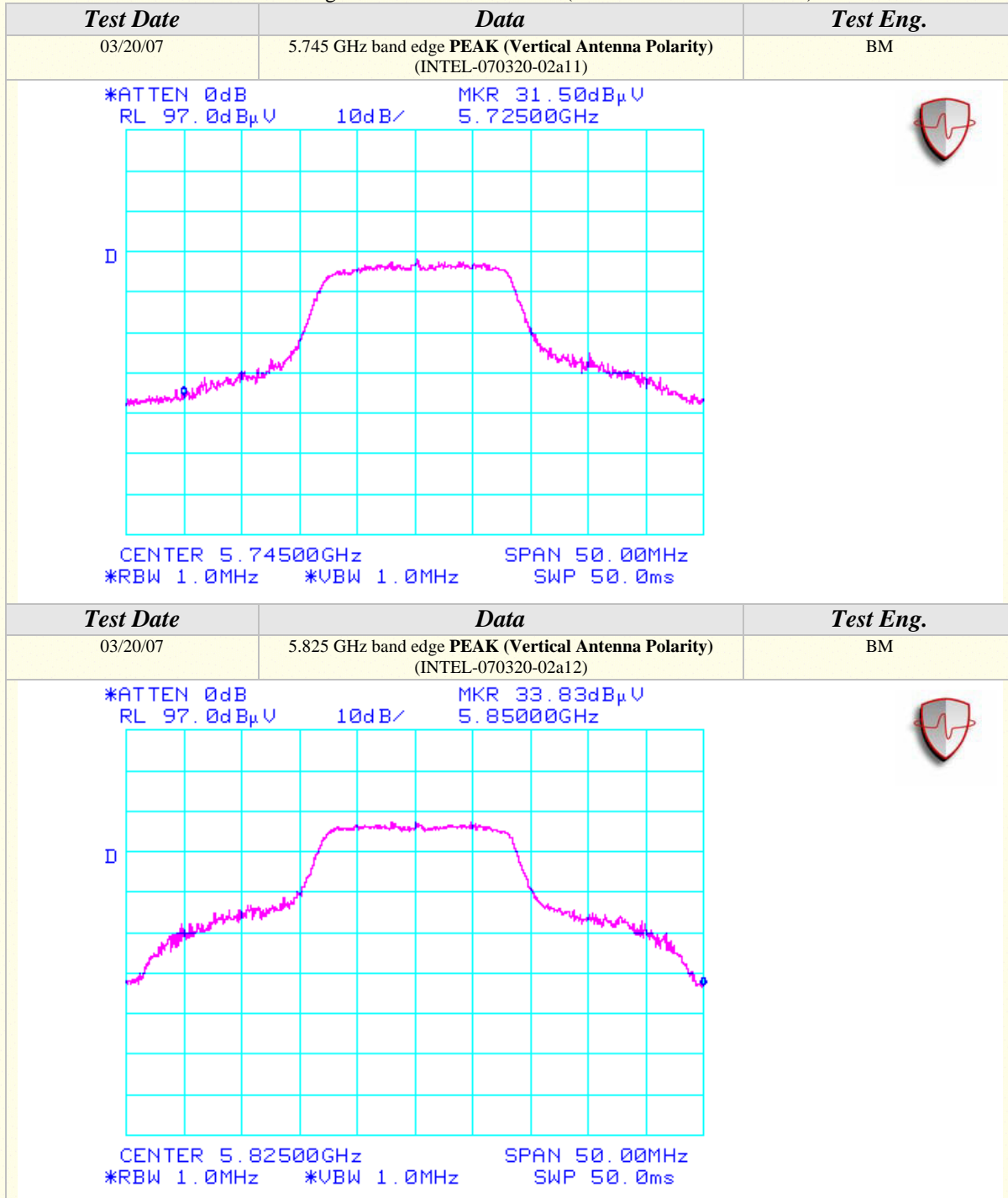



Radiated Emissions Test Results (Continued)

*Spurious Emissions Measurements in 802.11a mode (5745-5825 MHz)
 Channels 149, 157, & 165
 Continuous TX at Chain A Antenna port with Sony IRX-3980 Antennas
 Aegis Labs, Inc. File #: INTEL-070320-07*

RADIATED EMISSIONS - Horizontal Antenna Polarization												
Freq. (MHz)	Meter Reading (dBuV)	Antenna Height (cm)	Azimuth (degrees)	Quasi pk or AVG (dBuV)		Preamp Factor (dB)	Cable Factor (dB)	Ant. Factor (dB)	Corrected Reading (dBuV)	Limits (dBuV)	Diff (dB) +=FAIL	Comments
3830.00	64.50	100	270			50.78	2.57	33.13	49.41	74.00	-24.59	Ch. 149
3830.00				55.24	A	50.78	2.57	33.13	40.15	54.00	-13.85	
7660.00	62.50	100	225			50.15	3.69	37.40	53.43	74.00	-20.57	
7660.00				50.74	A	50.15	3.69	37.40	41.67	54.00	-12.33	
3856.76	64.83	100	225			50.76	2.45	32.50	49.02	74.00	-24.98	Ch. 157
3856.76				54.15	A	50.78	2.57	33.13	39.06	54.00	-14.94	
7713.25	61.67	100	225			50.15	3.69	37.40	52.60	74.00	-21.40	
7713.25				50.10	A	50.15	3.69	37.40	41.03	54.00	-12.97	
3883.35	65.00	100	225			50.78	2.57	33.13	49.91	74.00	-24.09	Ch.165
3883.35				53.35	A	50.15	3.69	37.40	44.28	54.00	-9.72	
7766.66	61.67	100	225			50.14	3.70	37.43	52.66	74.00	-21.34	
7766.66				49.90	A	50.14	3.70	37.43	40.89	54.00	-13.11	

RADIATED EMISSIONS - Vertical Antenna Polarization												
Freq. (MHz)	Meter Reading (dBuV)	Antenna Height (cm)	Azimuth (degrees)	Quasi pk or AVG (dBuV)		Preamp Factor (dB)	Cable Factor (dB)	Ant. Factor (dB)	Corrected Reading (dBuV)	Limits (dBuV)	Diff (dB) +=FAIL	Comments
3830.00	66.17	100	180			50.78	2.57	32.76	50.71	74.00	-23.29	Ch. 149
3830.00				57.32	A	50.78	2.57	32.76	41.86	54.00	-12.14	
7660.00	63.50	100	180			50.15	3.69	37.26	54.30	74.00	-19.70	
7660.00				52.09	A	50.15	3.69	37.26	42.89	54.00	-11.11	
3856.76	63.83	100	135			50.78	2.58	32.83	48.45	74.00	-25.55	Ch. 157
3856.76				53.54	A	50.78	2.58	32.83	38.16	54.00	-15.84	
7713.42	63.33	100	135			50.14	3.70	37.29	54.18	74.00	-19.82	
7713.42				51.51	A	50.14	3.70	37.29	42.36	54.00	-11.64	
3883.33	64.00	100	180			50.78	2.59	32.90	48.70	74.00	-25.30	Ch.165
3883.33				54.30	A	50.78	2.59	32.90	39.00	54.00	-15.00	
7766.66	62.67	100	180			50.13	3.72	37.31	53.56	74.00	-20.44	
7766.66				51.99	A	50.13	3.72	37.31	42.88	54.00	-11.12	



Radiated Emissions Test Results (Continued)

*Spurious Emissions Measurements in 802.11a mode (5745-5825 MHz)
 Channels 149, 157, & 165
 Continuous RX at Chain A Antenna port with Sony IRX-3980 Antennas
 Aegis Labs, Inc. File #: INTEL-070320-07*

RADIATED EMISSIONS - Horizontal Antenna Polarization

Freq. (MHz)	Meter Reading (dBuV)	Antenna Height (cm)	Azimuth (degrees)	Quasi pk or AVG (dBuV)		Preamp Factor (dB)	Cable Factor (dB)	Ant. Factor (dB)	Corrected Reading (dBuV)	Limits (dBuV)	Diff (dB) +=FAIL	Comments
3830.00	63.50	100	225			50.78	2.57	33.13	48.41	74.00	-25.59	Ch. 149
3830.00				52.87	A	50.78	2.57	33.13	37.78	54.00	-16.22	
3856.62	63.50	100	225			50.78	2.58	33.18	48.48	74.00	-25.52	Ch. 157
3856.62				53.63	A	50.78	2.58	33.18	38.61	54.00	-15.39	
3883.34	63.83	100	225			50.78	2.59	33.24	48.88	74.00	-25.12	Ch.165
3883.34				52.39	A	50.78	2.59	33.24	37.44	54.00	-16.56	

RADIATED EMISSIONS - Vertical Antenna Polarization

Freq. (MHz)	Meter Reading (dBuV)	Antenna Height (cm)	Azimuth (degrees)	Quasi pk or AVG (dBuV)		Preamp Factor (dB)	Cable Factor (dB)	Ant. Factor (dB)	Corrected Reading (dBuV)	Limits (dBuV)	Diff (dB) +=FAIL	Comments
3830.00	63.67	100	270			50.78	2.57	33.13	48.58	74.00	-25.42	Ch. 149
3830.00				53.28	A	50.78	2.57	33.13	38.19	54.00	-15.81	
3856.65	64.17	100	270			50.78	2.58	32.83	48.79	74.00	-25.21	Ch. 157
3856.65				53.41	A	50.78	2.58	32.83	38.03	54.00	-15.97	
3883.35	64.00	100	270			50.78	2.59	32.90	48.70	74.00	-25.30	Ch.165
3883.35				54.10	A	50.78	2.59	32.90	38.80	54.00	-15.20	



Radiated Emissions Test Results (Continued)

Fundamental Measurements in 802.11a mode (5745-5825 MHz)
Channels 149, 157, & 165
Continuous TX at Chain B Antenna port with Sony IRX-3980 Antennas
Aegis Labs, Inc. File #: INTEL-070320-03

RADIATED EMISSIONS - Horizontal Antenna Polarization												
Freq. (MHz)	Meter Reading (dBuV)	Antenna Height (cm)	Azimuth (degrees)	Quasi pk or AVG (dBuV)		Distance Factor (dB)	Cable Factor (dB)	Ant. Factor (dB)	Corrected Reading (dBuV)	Limits (dBuV)	Diff (dB) +=FAIL	Comments
5745.00	75.83	100	225			9.54	3.15	35.25	104.69			Ch. 149
5745.00				60.50	A	9.54	3.15	35.25	89.36			
5785.00	77.83	100	225			9.54	3.17	35.26	106.71			Ch. 157
5785.00				62.83	A	9.54	3.17	35.26	91.71			
5825.00	74.33	100	225			9.54	3.18	35.27	103.23			Ch. 165
5825.00				60.00	A	9.54	3.18	35.27	88.90			

RADIATED EMISSIONS - Vertical Antenna Polarization												
Freq. (MHz)	Meter Reading (dBuV)	Antenna Height (cm)	Azimuth (degrees)	Quasi pk or AVG (dBuV)		Distance Factor (dB)	Cable Factor (dB)	Ant. Factor (dB)	Corrected Reading (dBuV)	Limits (dBuV)	Diff (dB) +=FAIL	Comments
5745.00	72.50	100	225			9.54	3.15	35.05	101.16			Ch. 149
5745.00				57.83	A	9.54	3.15	35.05	86.49			
5785.00	75.17	100	225			9.54	3.17	35.07	103.87			Ch. 157
5785.00				60.33	A	9.54	3.17	35.07	89.03			
5825.00	72.00	100	225			9.54	3.18	35.10	100.73			Ch. 165
5825.00				57.33	A	9.54	3.18	35.10	86.06			

NOTE: Fundamental signals measured at 1 meter and extrapolated to 3 meters to calculate the radiated band edge field strengths.



Radiated Emissions Test Results (Continued)

*Band Edge Field Strength Measurements in 802.11a mode (5745-5825 MHz)
 Channels 149 & 165
 Continuous TX at Chain B Antenna port with Sony IRX-3980 Antennas
 Aegis Labs, Inc. File #: INTEL-070320-03*

RADIATED EMISSIONS - Horizontal Antenna Polarization												
<i>Freq. (MHz)</i>	<i>Meter Reading (dBuV)</i>	<i>Antenna Height (cm)</i>	<i>Azimuth (degrees)</i>	<i>Quasi pk or AVG (dBuV)</i>	<i>Distance Factor (dB)</i>	<i>Cable Factor (dB)</i>	<i>Ant. Factor (dB)</i>	<i>Corrected Reading (dBuV)</i>	<i>Limits (dBuV)</i>	<i>Diff (dB) +=FAIL</i>	<i>Comments</i>	
5725.00	43.67	100	225		9.54	3.15	35.25	72.52	84.69	-12.17	Ch. 149	
5850.00	34.33	100	225		9.54	3.19	35.27	63.25	83.23	-19.99	Ch. 165	

RADIATED EMISSIONS - Vertical Antenna Polarization												
<i>Freq. (MHz)</i>	<i>Meter Reading (dBuV)</i>	<i>Antenna Height (cm)</i>	<i>Azimuth (degrees)</i>	<i>Quasi pk or AVG (dBuV)</i>	<i>Distance Factor (dB)</i>	<i>Cable Factor (dB)</i>	<i>Ant. Factor (dB)</i>	<i>Corrected Reading (dBuV)</i>	<i>Limits (dBuV)</i>	<i>Diff (dB) +=FAIL</i>	<i>Comments</i>	
5725.00	42.67	100	225		9.54	3.15	35.04	71.31	81.16	-9.85	Ch. 149	
5850.00	30.17	100	225		9.54	3.19	35.11	58.93	80.73	-21.81	Ch. 165	

NOTE: The “Band Edge Field Strength” was calculated using the “Radiated Fundamental” measurements.

Radiated Emissions Test Results (Continued)

Plots Showing Out-Of-Band Emissions (Peak RBW=VBW=1MHz)

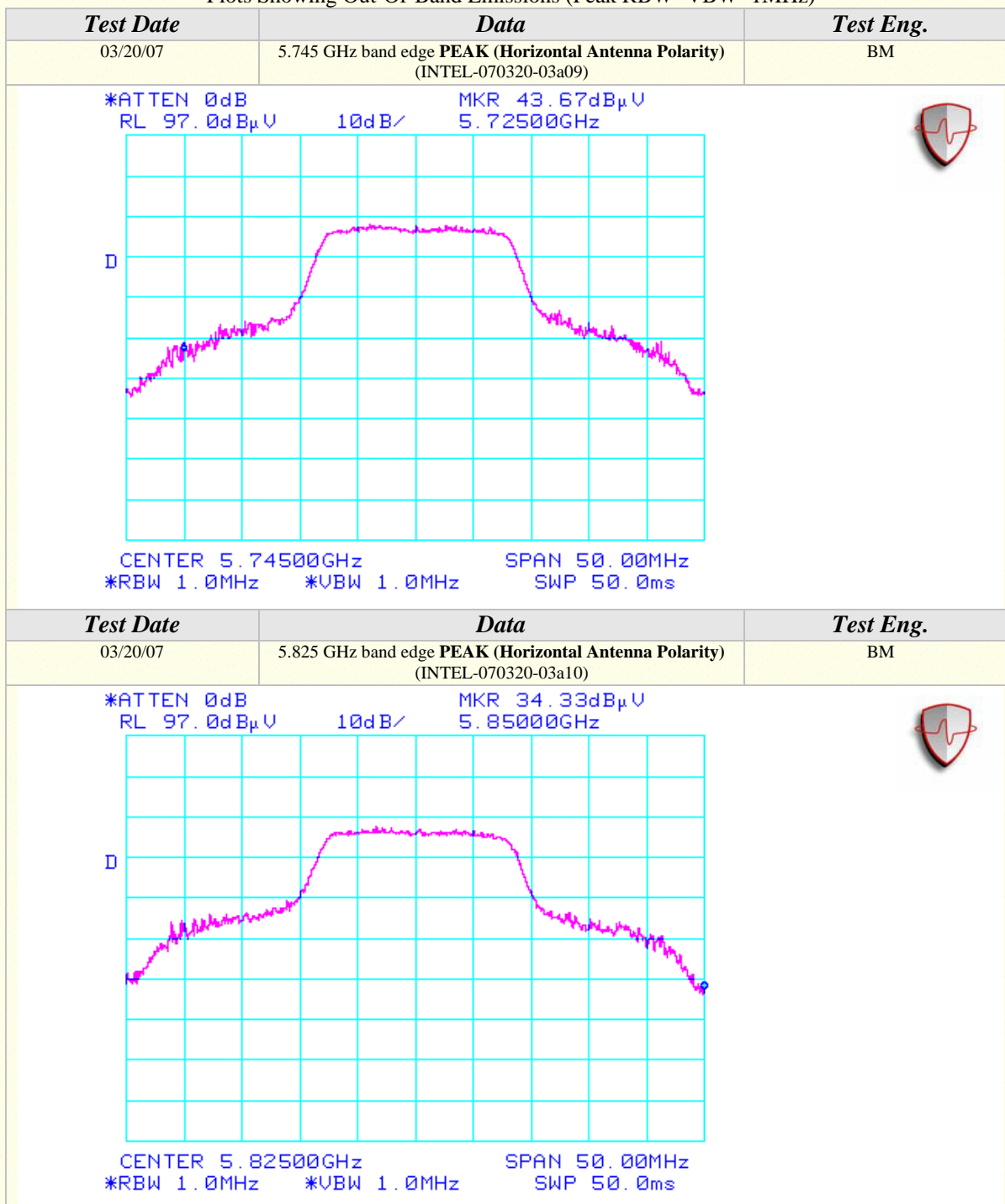

Radiated Emissions Test Results (Continued)

Plots Showing Out-Of-Band Emissions (Peak RBW=VBW=1MHz)

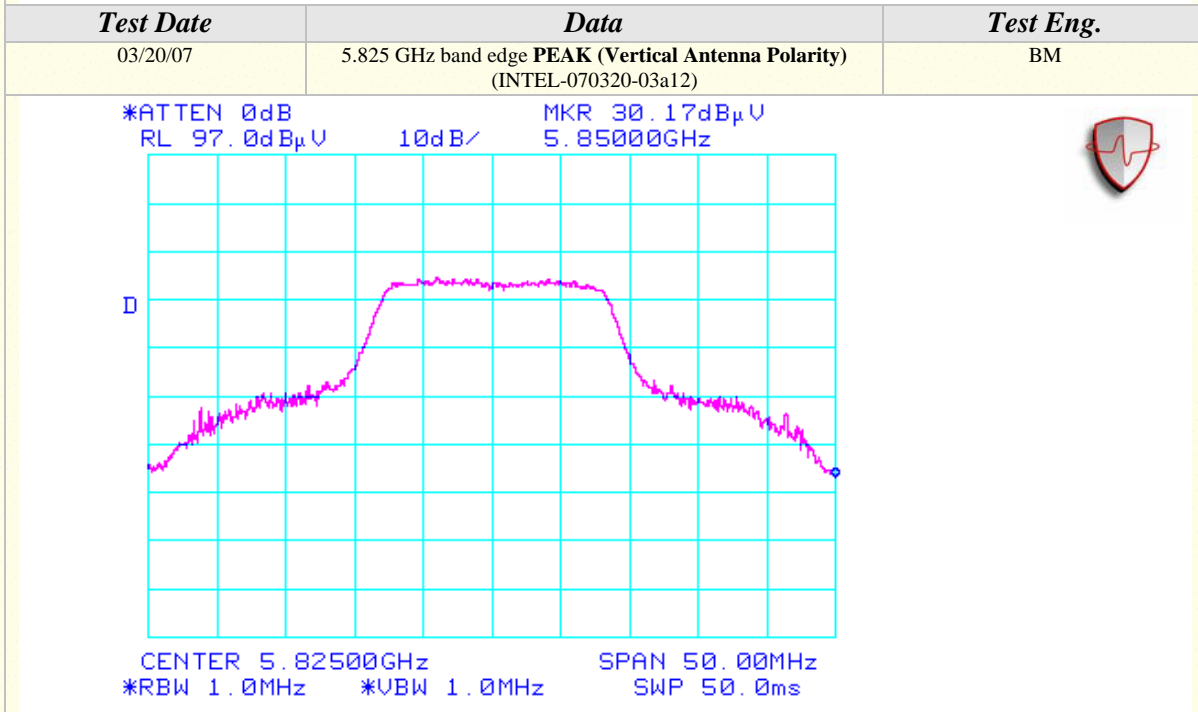
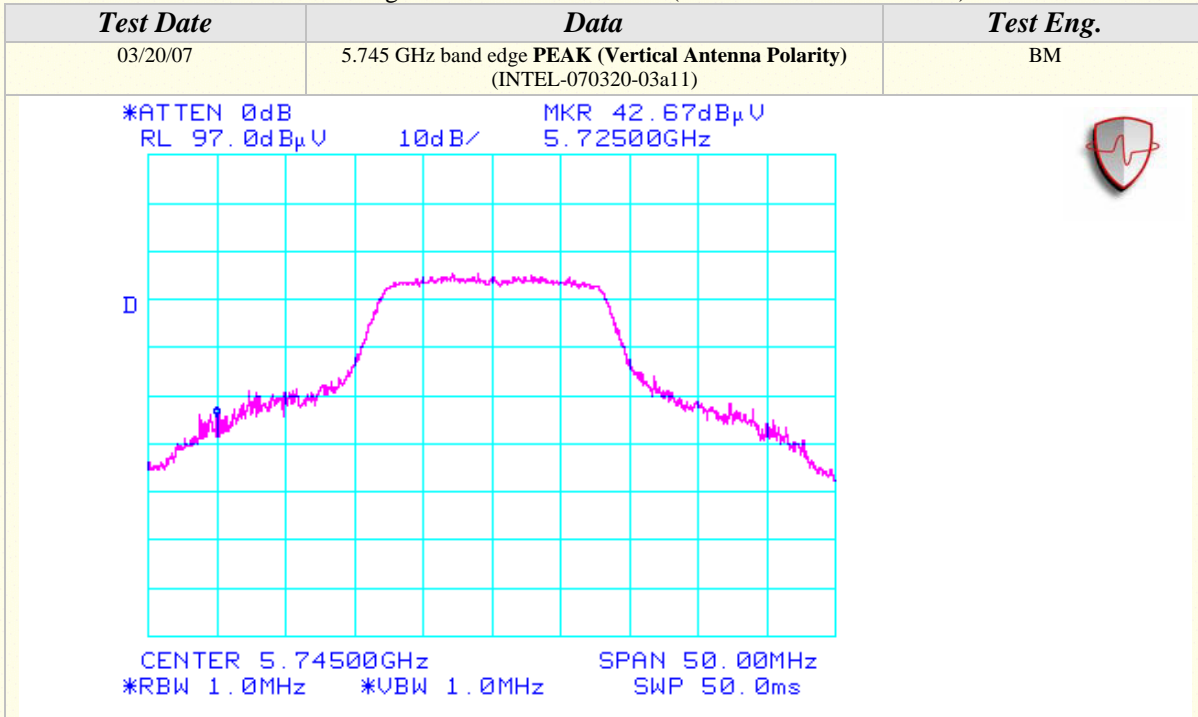



Radiated Emissions Test Results (Continued)

*Spurious Emissions Measurements in 802.11a mode (5745-5825 MHz)
 Channels 149, 157, & 165
 Continuous TX at Chain B Antenna port with Sony IRX-3980 Antennas
 Aegis Labs, Inc. File #: INTEL-070320-08*

RADIATED EMISSIONS - Horizontal Antenna Polarization

Freq. (MHz)	Meter Reading (dBuV)	Antenna Height (cm)	Azimuth (degrees)	Quasi pk or AVG (dBuV)		Preamp Factor (dB)	Cable Factor (dB)	Ant. Factor (dB)	Corrected Reading (dBuV)	Limits (dBuV)	Diff (dB) +=FAIL	Comments
3830.00	54.50	100	270			50.78	2.57	33.13	39.41	74.00	-34.59	Ch. 149
3830.00				45.24	A	50.78	2.57	33.13	30.15	54.00	-23.85	
7660.00	52.50	100	225			50.15	3.69	37.40	43.43	74.00	-30.57	
7660.00				40.74	A	50.15	3.69	37.40	31.67	54.00	-22.33	
3856.76	54.83	100	225			50.76	2.45	32.50	39.02	74.00	-34.98	Ch. 157
3856.76				44.15	A	50.78	2.57	33.13	29.06	54.00	-24.94	
7713.25	51.67	100	225			50.15	3.69	37.40	42.60	74.00	-31.40	
7713.25				40.10	A	50.15	3.69	37.40	31.03	54.00	-22.97	
3883.35	55.00	100	225			50.78	2.57	33.13	39.91	74.00	-34.09	Ch.165
3883.35				43.35	A	50.15	3.69	37.40	34.28	54.00	-19.72	
7766.66	51.67	100	225			50.14	3.70	37.43	42.66	74.00	-31.34	
7766.66				39.90	A	50.14	3.70	37.43	30.89	54.00	-23.11	

RADIATED EMISSIONS - Vertical Antenna Polarization

Freq. (MHz)	Meter Reading (dBuV)	Antenna Height (cm)	Azimuth (degrees)	Quasi pk or AVG (dBuV)		Preamp Factor (dB)	Cable Factor (dB)	Ant. Factor (dB)	Corrected Reading (dBuV)	Limits (dBuV)	Diff (dB) +=FAIL	Comments
3830.00	56.17	100	180			50.78	2.57	32.76	40.71	74.00	-33.29	Ch. 149
3830.00				47.32	A	50.78	2.57	32.76	31.86	54.00	-22.14	
7660.00	53.50	100	180			50.15	3.69	37.26	44.30	74.00	-29.70	
7660.00				42.09	A	50.15	3.69	37.26	32.89	54.00	-21.11	
3856.76	53.83	100	135			50.78	2.58	32.83	38.45	74.00	-35.55	Ch. 157
3856.76				43.54	A	50.78	2.58	32.83	28.16	54.00	-25.84	
7713.42	53.33	100	135			50.14	3.70	37.29	44.18	74.00	-29.82	
7713.42				41.51	A	50.14	3.70	37.29	32.36	54.00	-21.64	
3883.33	54.00	100	180			50.78	2.59	32.90	38.70	74.00	-35.30	Ch.165
3883.33				44.30	A	50.78	2.59	32.90	29.00	54.00	-25.00	
7766.66	52.67	100	180			50.13	3.72	37.31	43.56	74.00	-30.44	
7766.66				41.99	A	50.13	3.72	37.31	32.88	54.00	-21.12	



Radiated Emissions Test Results (Continued)

*Spurious Emissions Measurements in 802.11a mode (5745-5825 MHz)
Channels 149, 157, & 165
Continuous RX at Chain B Antenna port with Sony IRX-3980 Antennas
Aegis Labs, Inc. File #: INTEL-070320-08*

RADIATED EMISSIONS - Horizontal Antenna Polarization

Freq. (MHz)	Meter Reading (dBuV)	Antenna Height (cm)	Azimuth (degrees)	Quasi pk or AVG (dBuV)		Preamp Factor (dB)	Cable Factor (dB)	Ant. Factor (dB)	Corrected Reading (dBuV)	Limits (dBuV)	Diff (dB) +=FAIL	Comments
3830.00	53.50	100	225			50.78	2.57	33.13	38.41	74.00	-35.59	Ch. 149
3830.00				42.87	A	50.78	2.57	33.13	27.78	54.00	-26.22	
3856.62	53.50	100	225			50.78	2.58	33.18	38.48	74.00	-35.52	Ch. 157
3856.62				43.63	A	50.78	2.58	33.18	28.61	54.00	-25.39	
3883.34	53.83	100	225			50.78	2.59	33.24	38.88	74.00	-35.12	Ch.165
3883.34				42.39	A	50.78	2.59	33.24	27.44	54.00	-26.56	

RADIATED EMISSIONS - Vertical Antenna Polarization

Freq. (MHz)	Meter Reading (dBuV)	Antenna Height (cm)	Azimuth (degrees)	Quasi pk or AVG (dBuV)		Preamp Factor (dB)	Cable Factor (dB)	Ant. Factor (dB)	Corrected Reading (dBuV)	Limits (dBuV)	Diff (dB) +=FAIL	Comments
3830.00	53.67	100	270			50.78	2.57	33.13	38.58	74.00	-35.42	Ch. 149
3830.00				43.28	A	50.78	2.57	33.13	28.19	54.00	-25.81	
3856.65	54.17	100	270			50.78	2.58	32.83	38.79	74.00	-35.21	Ch. 157
3856.65				43.41	A	50.78	2.58	32.83	28.03	54.00	-25.97	
3883.35	54.00	100	270			50.78	2.59	32.90	38.70	74.00	-35.30	Ch.165
3883.35				44.10	A	50.78	2.59	32.90	28.80	54.00	-25.20	



RADIATED EMISSIONS TEST RESULTS

CLIENT:	Intel Corporation	DATE:	03/20/07
EUT:	Intel Wireless WiFi Link 4965AGN	PROJECT NUMBER:	INTEL-070320
MODEL NUMBER:	4965AGN	TEST ENGINEER:	BM/JC
SERIAL NUMBER:	0013E804612B	SITE #:	1
CONFIGURATION:	Tested installed in the host computer's mini PCI slot in 802.11b (2400-2483.5 MHz) mode with Sony IRX-3980 Antennas.	TEMPERATURE:	15 deg. C
		HUMIDITY:	52% RH
		TIME:	5:30 PM

Description:	Radiated RF Emissions (1 GHz – 18 GHz)
Results:	PASSED Horizontal and Vertical Antenna Polarizations Class B Limits
Note:	Radiated Emissions Measurements were performed on the EUT with power supply set at the following voltage and frequency. <ul style="list-style-type: none"> • 120VAC / 60 Hz.

Unwanted Spurious Emissions Limits			
Frequency (MHz)	Field Strength (uV/m)	Field Strength (dBuV/m) (Emissions in the restricted bands)	Field Strength (dBm/MHz) (Emissions outside the restricted bands)
Above 960	500	54.00 (Average) 74.00 (Peak)	< -20 dBc

Radiated Emissions Sample Calculations

$$\text{Corrected Meter Reading} = \text{Meter Reading} + F + C - D$$

Where, F = Antenna Factor

C = Cable Factor

G = Amplifier Gain

D = Distance Factor (if applicable)

Therefore, the equation for determining the Corrected Meter Reading Limit (CML) is:

$$\text{CML} = \text{Specification Limit} - F - C + D$$



Radiated Emissions Test Results (Continued)

*Fundamental Measurements in 802.11b mode (2400-2483.5 MHz)
Channels 1, 6, & 11
Continuous TX at Chain A Antenna port with Sony IRX-3980 Antennas
Aegis Labs, Inc. File #: INTEL-070320-02*

RADIATED EMISSIONS - Horizontal Antenna Polarization												
Freq. (MHz)	Meter Reading (dBuV)	Antenna Height (cm)	Azimuth (degrees)	Quasi pk or AVG (dBuV)		Distance Factor (dB)	Cable Factor (dB)	Ant. Factor (dB)	Corrected Reading (dBuV)	Limits (dBuV)	Diff (dB) +=FAIL	Comments
2412.00	51.83	100	225			9.54	1.99	29.50	73.78			Ch. 1
2412.00				48.17	A	9.54	1.99	29.50	70.12			
2437.00	52.17	100	225			9.54	2.00	29.59	74.22			Ch. 6
2437.00				48.33	A	9.54	2.00	29.59	70.38			
2462.00	53.83	100	225			9.54	2.01	29.67	75.97			Ch. 11
2462.00				50.17	A	9.54	2.01	29.67	72.31			

RADIATED EMISSIONS - Vertical Antenna Polarization												
Freq. (MHz)	Meter Reading (dBuV)	Antenna Height (cm)	Azimuth (degrees)	Quasi pk or AVG (dBuV)		Distance Factor (dB)	Cable Factor (dB)	Ant. Factor (dB)	Corrected Reading (dBuV)	Limits (dBuV)	Diff (dB) +=FAIL	Comments
2412.00	55.50	100	225			9.54	1.99	29.04	76.99			Ch. 1
2412.00				51.00	A	9.54	1.99	29.04	72.49			
2437.00	52.17	100	225			9.54	2.00	29.11	73.74			Ch. 6
2437.00				48.17	A	9.54	2.00	29.11	69.74			
2462.00	54.67	100	225			9.54	2.01	29.19	76.33			Ch. 11
2462.00				51.00	A	9.54	2.01	29.19	72.66			

NOTE: Fundamental signals measured at 1 meter and extrapolated to 3 meters to calculate the radiated band edge field strengths.



Radiated Emissions Test Results (Continued)

*Band Edge Field Strength Measurements in 802.11b mode (2400-2483.5 MHz)
 Channels 1 & 11
 Continuous TX at Chain A Antenna port with Sony IRX-3980 Antennas
 Aegis Labs, Inc. File #: INTEL-070320-02*

RADIATED EMISSIONS - Horizontal Antenna Polarization												
Freq. (MHz)	Meter Reading (dBuV)	Antenna Height (cm)	Azimuth (degrees)	Quasi pk or AVG (dBuV)		Distance Factor (dB)	Cable Factor (dB)	Ant. Factor (dB)	Corrected Reading (dBuV)	Limits (dBuV)	Diff (dB) +=FAIL	Comments
2390.00	31.67	100	225			9.54	1.98	29.43	53.54	74.00	-20.46	Ch. 1
2390.00				18.00	A	9.54	1.98	29.43	39.87	54.00	-14.13	
2400.00	30.50	100	225			9.54	1.98	29.46	52.40	53.78	-1.38	
2483.50	29.50	100	225			9.54	2.02	29.74	51.73	74.00	-22.27	Ch. 11
2483.50				18.17	A	9.54	2.02	29.74	40.40	54.00	-13.60	

RADIATED EMISSIONS - Vertical Antenna Polarization												
Freq. (MHz)	Meter Reading (dBuV)	Antenna Height (cm)	Azimuth (degrees)	Quasi pk or AVG (dBuV)		Distance Factor (dB)	Cable Factor (dB)	Ant. Factor (dB)	Corrected Reading (dBuV)	Limits (dBuV)	Diff (dB) +=FAIL	Comments
2390.00	29.17	100	225			9.54	1.98	28.97	50.58	74.00	-23.42	Ch. 1
2390.00				18.00	A	9.54	1.98	28.97	39.41	54.00	-14.59	
2400.00	30.33	100	225			9.54	1.98	29.00	51.77	56.99	-5.21	
2483.50	29.17	100	225			9.54	2.02	29.25	50.90	74.00	-23.10	Ch. 11
2483.50				18.33	A	9.54	2.02	29.25	40.06	54.00	-13.94	

NOTE: The “Band Edge Field Strength” was calculated using the “Radiated Fundamental” measurements.

Radiated Emissions Test Results (Continued)

Plots Showing Out-Of-Band Emissions (Peak RBW=VBW=1MHz; Average RBW = 1MHz, VBW = 10Hz)

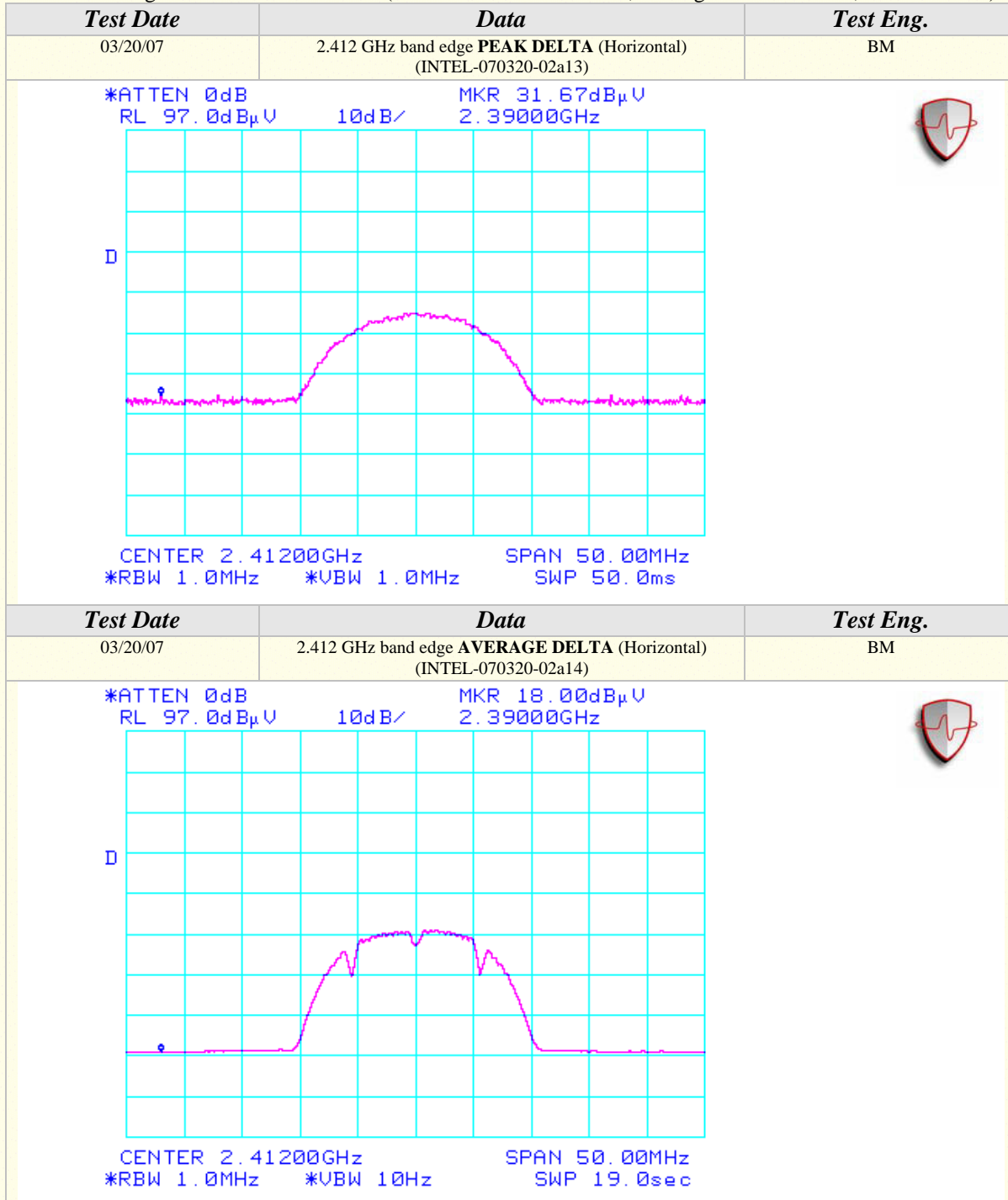

Radiated Emissions Test Results (Continued)

Plots Showing Out-Of-Band Emissions (Peak RBW=VBW=1MHz; Average RBW = 1MHz, VBW = 10Hz)

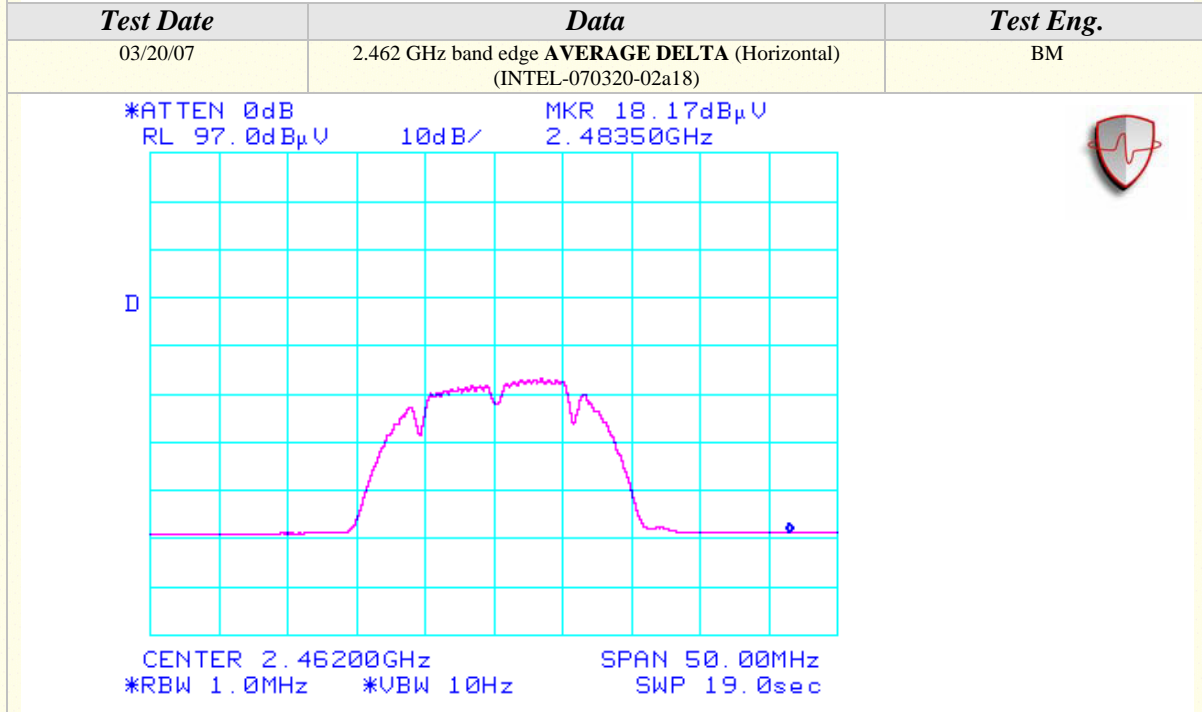
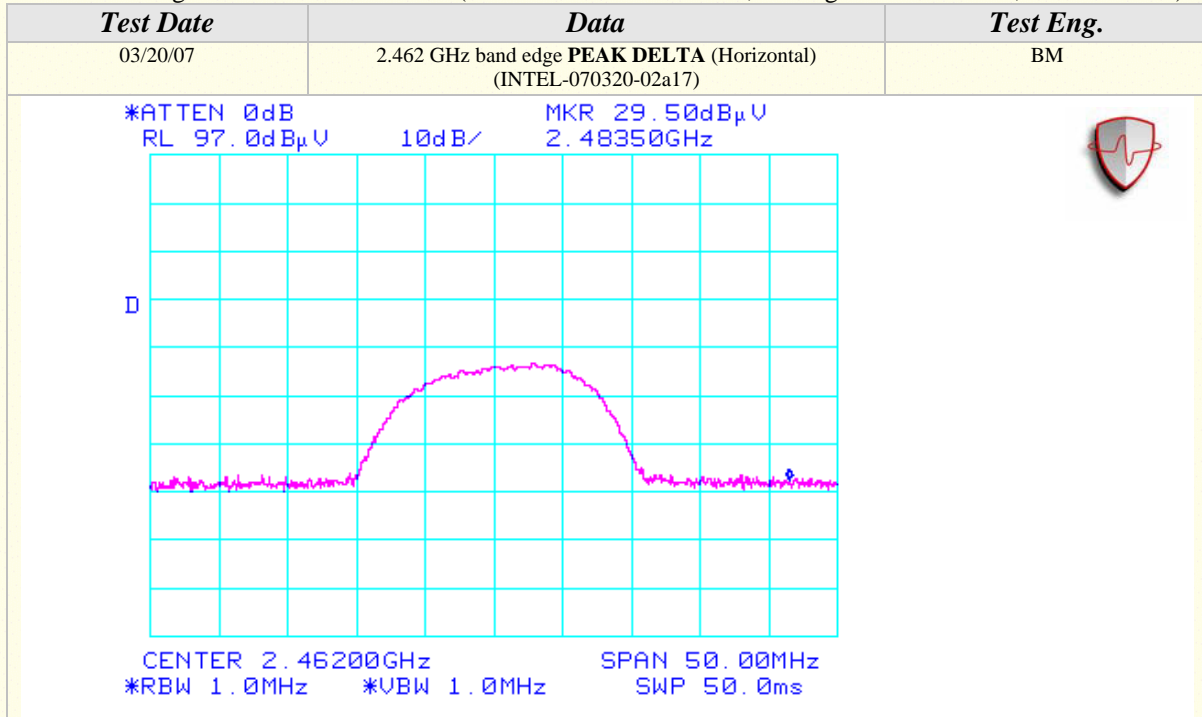

Radiated Emissions Test Results (Continued)

Plots Showing Out-Of-Band Emissions (Peak RBW=VBW=1MHz; Average RBW = 1MHz, VBW = 10Hz)

Test Date	Data	Test Eng.
03/20/07	2.462 GHz band edge PEAK DELTA (Vertical) (INTEL-070320-02a19)	BM
<div style="display: flex; justify-content: space-between;"> <div style="width: 60%;"> <p>*ATTEN 0dB MKR 29.17dBµV RL 97.0dBµV 10dB/ 2.48350GHz</p> <p>CENTER 2.46200GHz SPAN 50.00MHz *RBW 1.0MHz *VBW 1.0MHz SWP 50.0ms</p> </div> <div style="width: 35%; text-align: center;"> </div> </div>		
Test Date	Data	Test Eng.
03/20/07	2.462 GHz band edge AVERAGE DELTA (Vertical) (INTEL-070320-02a20)	BM
<div style="display: flex; justify-content: space-between;"> <div style="width: 60%;"> <p>*ATTEN 0dB MKR 18.33dBµV RL 97.0dBµV 10dB/ 2.48350GHz</p> <p>CENTER 2.46200GHz SPAN 50.00MHz *RBW 1.0MHz *VBW 10Hz SWP 19.0sec</p> </div> <div style="width: 35%; text-align: center;"> </div> </div>		



Radiated Emissions Test Results (Continued)

*Spurious Emissions Measurements in 802.11b mode (2400-2483.5 MHz)
Channels 1, 6, & 11
Continuous TX at Chain A Antenna port with Sony IRX-3980 Antennas
Aegis Labs, Inc. File #: INTEL-070320-12*

RADIATED EMISSIONS - Horizontal Antenna Polarization												
Freq. (MHz)	Meter Reading (dBuV)	Antenna Height (cm)	Azimuth (degrees)	Quasi pk or AVG (dBuV)		Distance Factor (dB)	Cable Factor (dB)	Ant. Factor (dB)	Corrected Reading (dBuV)	Limits (dBuV)	Diff (dB) +=FAIL	Comments
2720.00	32.83	100	225			9.54	2.12	30.42	55.83	74.00	-18.17	Ch. 1
2720.00				21.15	A	9.54	2.12	30.42	44.15	54.00	-9.85	
2720.00	33.17	100	225			9.54	2.12	30.42	56.17	74.00	-17.83	Ch. 6
2720.00				22.46	A	9.54	2.12	30.42	45.46	54.00	-8.54	
2720.00	33.50	100	225			9.54	2.12	30.42	56.50	74.00	-17.50	Ch. 11
2720.00				21.94	A	9.54	2.12	30.42	44.94	54.00	-9.06	

RADIATED EMISSIONS - Vertical Antenna Polarization												
Freq. (MHz)	Meter Reading (dBuV)	Antenna Height (cm)	Azimuth (degrees)	Quasi pk or AVG (dBuV)		Distance Factor (dB)	Cable Factor (dB)	Ant. Factor (dB)	Corrected Reading (dBuV)	Limits (dBuV)	Diff (dB) +=FAIL	Comments
2720.00	33.50	100	225			9.54	2.12	29.96	56.04	74.00	-17.96	Ch. 1
2720.00				23.73	A	9.54	2.12	29.96	46.27	54.00	-7.73	
2720.00	32.83	100	225			9.54	2.12	29.96	55.37	74.00	-18.63	Ch. 6
2720.00				21.51	A	9.54	2.12	29.96	44.05	54.00	-9.95	
2720.00	32.83	100	225			9.54	2.12	29.96	55.37	74.00	-18.63	Ch. 11
2720.00				22.29	A	9.54	2.12	29.96	44.83	54.00	-9.17	



Spurious Radiated Emissions Test Results (Continued)

*Spurious Emissions Measurements in 802.11b mode (2400-2483.5 MHz)
 Channels 1, 6, & 11
 Continuous TX at Chain A Antenna port with Sony IRX-3980 Antennas
 Aegis Labs, Inc. File #: INTEL-070320-07*

RADIATED EMISSIONS - Horizontal Antenna Polarization												
Freq. (MHz)	Meter Reading (dBuV)	Antenna Height (cm)	Azimuth (degrees)	Quasi pk or AVG (dBuV)		Preamp Factor (dB)	Cable Factor (dB)	Ant. Factor (dB)	Corrected Reading (dBuV)	Limits (dBuV)	Diff (dB) +=FAIL	Comments
4824.00	61.33	100	225			51.08	2.87	33.91	47.04	74.00	-26.96	Ch. 1
4824.00				55.73	A	51.08	2.87	33.91	41.44	54.00	-12.56	
9648.01	56.17	100	225			50.15	4.15	38.12	48.28	53.78	-5.50	
4873.99	60.83	100	225			51.12	2.89	34.02	46.62	74.00	-27.38	Ch. 6
4873.99				55.14	A	51.12	2.89	34.02	40.93	54.00	-13.07	
9747.96	56.83	100	225			50.19	4.18	38.20	49.02	54.22	-5.20	
4924.00	59.67	100	225			51.15	2.90	34.13	45.55	74.00	-28.45	Ch. 11
4924.00				53.94	A	51.15	2.90	34.13	39.82	54.00	-14.18	
9848.01	55.33	100	225			50.23	4.21	38.28	47.59	55.97	-8.38	

RADIATED EMISSIONS - Vertical Antenna Polarization												
Freq. (MHz)	Meter Reading (dBuV)	Antenna Height (cm)	Azimuth (degrees)	Quasi pk or AVG (dBuV)		Preamp Factor (dB)	Cable Factor (dB)	Ant. Factor (dB)	Corrected Reading (dBuV)	Limits (dBuV)	Diff (dB) +=FAIL	Comments
4824.01	60.00	100	135			51.08	2.87	33.78	45.58	74.00	-28.42	Ch. 1
4824.01				52.79	A	51.08	2.87	33.78	38.37	54.00	-15.63	
9648.01	58.67	100	225			50.15	4.15	38.09	50.76	56.99	-6.23	
4873.99	61.33	100	135			51.12	2.89	33.87	46.97	74.00	-27.03	Ch. 6
4873.99				53.48	A	51.12	2.89	33.87	39.12	54.00	-14.88	
9747.96	58.67	100	180			50.19	4.18	38.15	50.81	53.74	-2.93	
4924.05	59.00	100	135			51.15	2.90	33.96	44.71	74.00	-29.29	Ch. 11
4924.05				52.49	A	51.15	2.90	33.96	38.20	54.00	-15.80	
9848.06	57.17	100	180			50.23	4.21	38.21	49.36	56.33	-6.97	



Radiated Emissions Test Results (Continued)

*Spurious Emissions Measurements in 802.11b mode (2400-2483.5 MHz)
 Channels 1, 6, & 11
 Continuous RX at Chain A Antenna port with Sony IRX-3980 Antennas
 Aegis Labs, Inc. File #: INTEL-070320-07*

RADIATED EMISSIONS - Horizontal Antenna Polarization

Freq. (MHz)	Meter Reading (dBuV)	Antenna Height (cm)	Azimuth (degrees)	Quasi pk or AVG (dBuV)		Preamp Factor (dB)	Cable Factor (dB)	Ant. Factor (dB)	Corrected Reading (dBuV)	Limits (dBuV)	Diff (dB) +=FAIL	Comments
4824.00	63.00	100	225			51.08	2.87	33.91	48.71	74.00	-25.29	Ch. 1
4824.00				50.35	A	51.08	2.87	33.91	36.06	54.00	-17.94	
4874.00	56.50	100	225			51.12	2.89	34.02	42.29	74.00	-31.71	Ch. 6
4874.00				49.67	A	51.12	2.89	34.02	35.46	54.00	-18.54	
4924.00	56.67	100	225			51.15	2.90	34.13	42.55	74.00	-31.45	Ch. 11
4924.00				50.22	A	51.15	2.90	34.13	36.10	54.00	-17.90	

RADIATED EMISSIONS - Vertical Antenna Polarization

Freq. (MHz)	Meter Reading (dBuV)	Antenna Height (cm)	Azimuth (degrees)	Quasi pk or AVG (dBuV)		Preamp Factor (dB)	Cable Factor (dB)	Ant. Factor (dB)	Corrected Reading (dBuV)	Limits (dBuV)	Diff (dB) +=FAIL	Comments
4824.00	62.67	100	225			51.08	2.87	33.78	48.25	74.00	-25.75	Ch. 1
4824.00				50.16	A	51.08	2.87	33.78	35.74	54.00	-18.26	
4874.00	62.00	100	225			51.12	2.89	33.87	47.64	74.00	-26.36	Ch. 6
4874.00				49.64	A	51.12	2.89	33.87	35.28	54.00	-18.72	
4924.00	62.33	100	225			51.15	2.90	33.96	48.04	74.00	-25.96	Ch. 11
4924.00				50.03	A	51.15	2.90	33.96	35.74	54.00	-18.26	



Radiated Emissions Test Results (Continued)

*Fundamental Measurements in 802.11b mode (2400-2483.5 MHz)
Channels 1, 6, & 11
Continuous TX at Chain B Antenna port with Sony IRX-3980 Antennas
Aegis Labs, Inc. File #: INTEL-070320-03*

RADIATED EMISSIONS - Horizontal Antenna Polarization												
Freq. (MHz)	Meter Reading (dBuV)	Antenna Height (cm)	Azimuth (degrees)	Quasi pk or AVG (dBuV)		Distance Factor (dB)	Cable Factor (dB)	Ant. Factor (dB)	Corrected Reading (dBuV)	Limits (dBuV)	Diff (dB) +=FAIL	Comments
2412.00	73.50	100	180			9.54	1.99	29.50	95.45			Ch. 1
2412.00				69.50	A	9.54	1.99	29.50	91.45			
2437.00	71.33	100	225			9.54	2.00	29.59	93.38			Ch. 6
2437.00				67.33	A	9.54	2.00	29.59	89.38			
2462.00	73.00	100	180			9.54	2.01	29.67	95.14			Ch. 11
2462.00				68.83	A	9.54	2.01	29.67	90.97			

RADIATED EMISSIONS - Vertical Antenna Polarization												
Freq. (MHz)	Meter Reading (dBuV)	Antenna Height (cm)	Azimuth (degrees)	Quasi pk or AVG (dBuV)		Distance Factor (dB)	Cable Factor (dB)	Ant. Factor (dB)	Corrected Reading (dBuV)	Limits (dBuV)	Diff (dB) +=FAIL	Comments
2412.00	73.67	100	135			9.54	1.99	29.04	95.16			Ch. 1
2412.00				69.50	A	9.54	1.99	29.04	90.99			
2437.00	75.50	100	135			9.54	2.00	29.11	97.07			Ch. 6
2437.00				71.83	A	9.54	2.00	29.11	93.40			
2462.00	70.17	100	225			9.54	2.01	29.19	91.83			Ch. 11
2462.00				66.67	A	9.54	2.01	29.19	88.33			

NOTE: Fundamental signals measured at 1 meter and extrapolated to 3 meters to calculate the radiated band edge field strengths.



Radiated Emissions Test Results (Continued)

*Band Edge Field Strength Measurements in 802.11b mode (2400-2483.5 MHz)
 Channels 1 & 11
 Continuous TX at Chain B Antenna port with Sony IRX-3980 Antennas
 Aegis Labs, Inc. File #: INTEL-070320-03*

RADIATED EMISSIONS - Horizontal Antenna Polarization												
Freq. (MHz)	Meter Reading (dBuV)	Antenna Height (cm)	Azimuth (degrees)	Quasi pk or AVG (dBuV)		Distance Factor (dB)	Cable Factor (dB)	Ant. Factor (dB)	Corrected Reading (dBuV)	Limits (dBuV)	Diff (dB) +=FAIL	Comments
2390.00	32.33	100	180			9.54	1.98	29.43	54.20	74.00	-19.80	Ch. 1
2390.00				19.67	A	9.54	1.98	29.43	41.54	54.00	-12.46	
2400.00	41.17	100	180			9.54	1.98	29.46	63.07	75.45	-12.38	
2483.50	31.50	100	180			9.54	2.02	29.74	53.73	74.00	-20.27	Ch. 11
2483.50				19.17	A	9.54	2.02	29.74	41.40	54.00	-12.60	

RADIATED EMISSIONS - Vertical Antenna Polarization												
Freq. (MHz)	Meter Reading (dBuV)	Antenna Height (cm)	Azimuth (degrees)	Quasi pk or AVG (dBuV)		Distance Factor (dB)	Cable Factor (dB)	Ant. Factor (dB)	Corrected Reading (dBuV)	Limits (dBuV)	Diff (dB) +=FAIL	Comments
2390.00	31.83	100	135			9.54	1.98	28.97	53.24	74.00	-20.76	Ch. 1
2390.00				19.33	A	9.54	1.98	28.97	40.74	54.00	-13.26	
2400.00	41.83	100	135			9.54	1.98	29.00	63.27	75.16	-11.88	
2483.50	29.67	100	225			9.54	2.02	29.25	51.40	74.00	-22.60	Ch. 11
2483.50				18.67	A	9.54	2.02	29.25	40.40	54.00	-13.60	

NOTE: The “Band Edge Field Strength” was calculated using the “Radiated Fundamental” measurements.

Radiated Emissions Test Results (Continued)

Plots Showing Out-Of-Band Emissions (Peak RBW=VBW=1MHz; Average RBW = 1MHz, VBW = 10Hz)

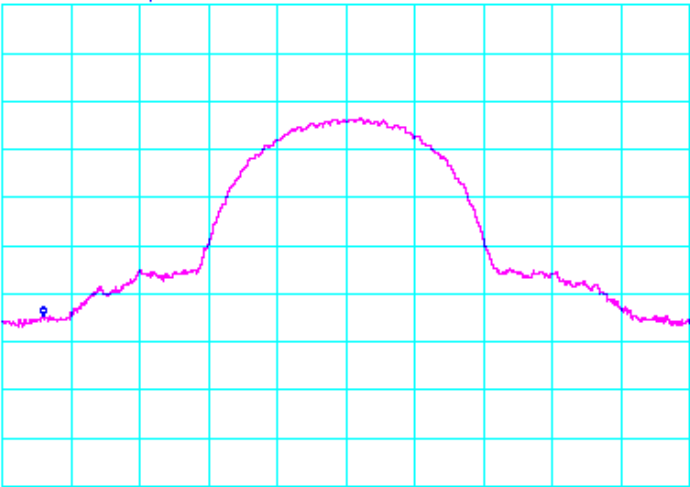
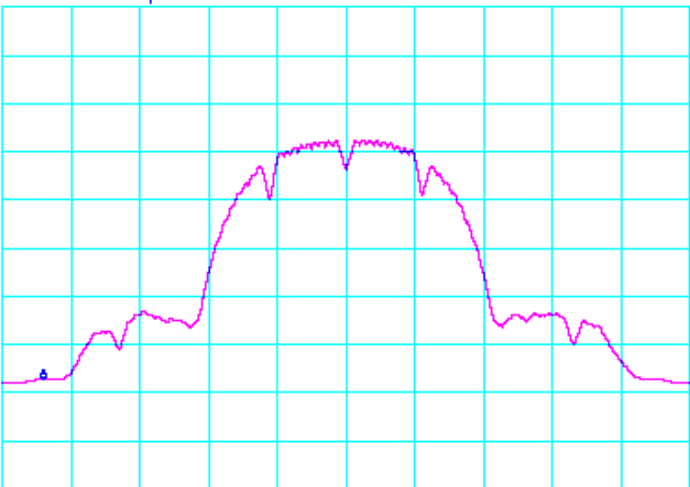
Test Date	Data	Test Eng.
03/20/07	2.412 GHz band edge PEAK DELTA (Horizontal) (INTEL-070320-03a13)	BM
<div style="display: flex; justify-content: space-between;"> *ATTEN 0dB RL 97.0dBµV 10dB/ MKR 32.33dBµV 2.39000GHz </div>  <div style="display: flex; justify-content: space-between; margin-top: 10px;"> CENTER 2.41200GHz *RBW 1.0MHz SPAN 50.00MHz SWP 50.0ms </div>		
03/20/07	2.412 GHz band edge AVERAGE DELTA (Horizontal) (INTEL-070320-03a14)	BM
<div style="display: flex; justify-content: space-between;"> *ATTEN 0dB RL 97.0dBµV 10dB/ MKR 19.67dBµV 2.39000GHz </div>  <div style="display: flex; justify-content: space-between; margin-top: 10px;"> CENTER 2.41200GHz *RBW 1.0MHz SPAN 50.00MHz *VBW 10Hz SWP 19.0sec </div>		



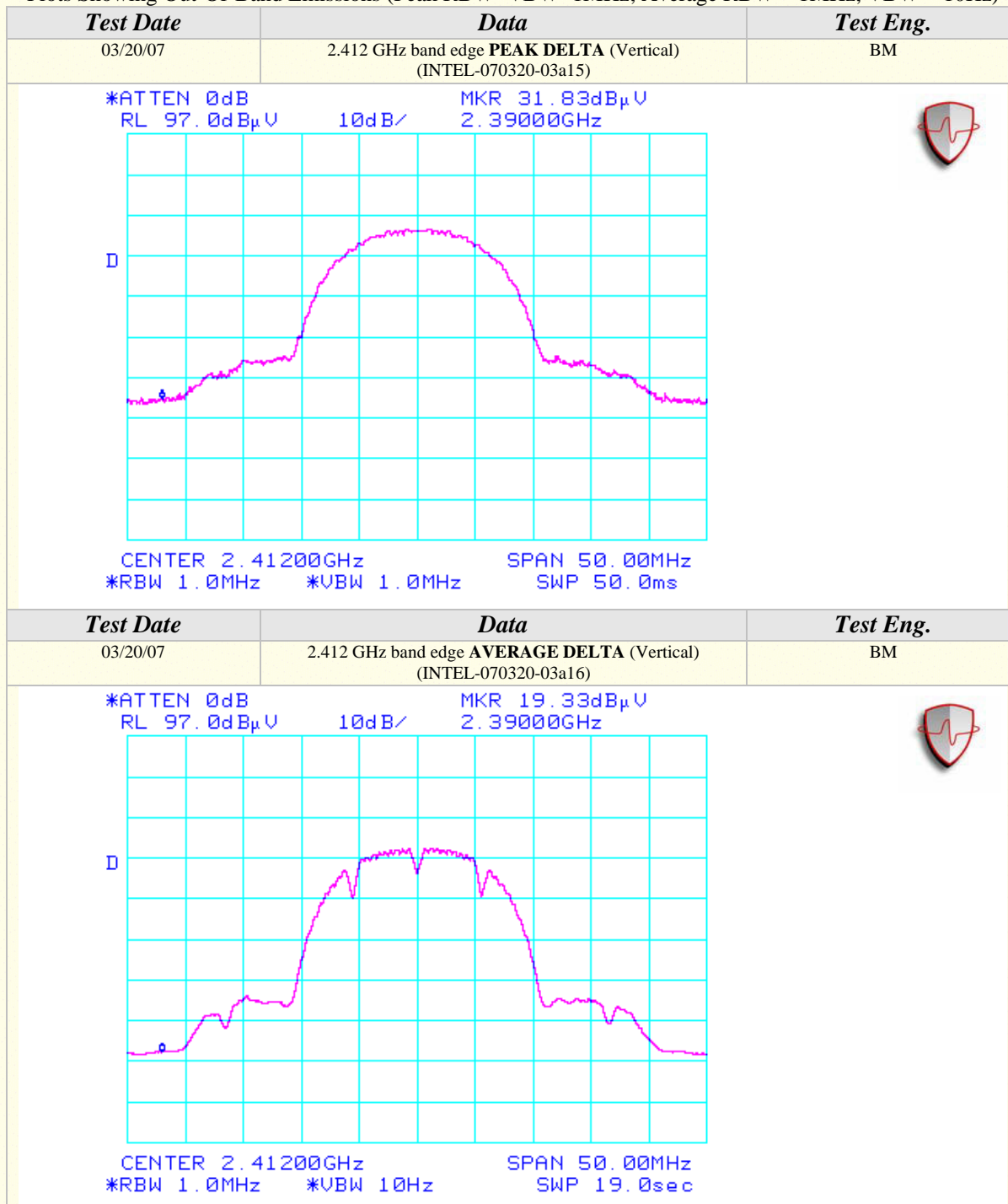

Radiated Emissions Test Results (Continued)

Plots Showing Out-Of-Band Emissions (Peak RBW=VBW=1MHz; Average RBW = 1MHz, VBW = 10Hz)

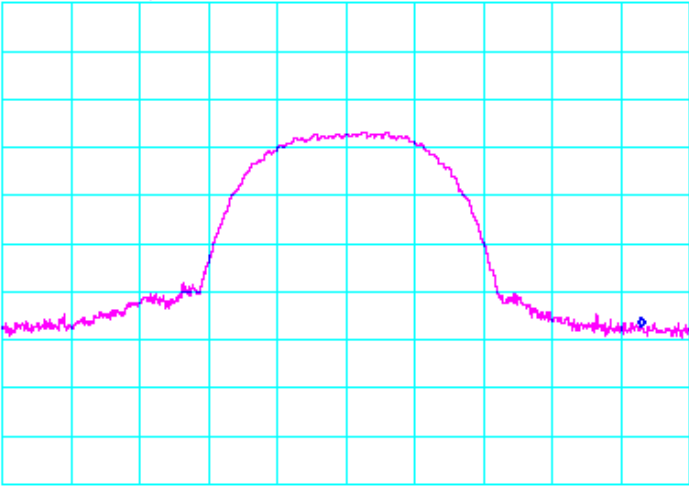

Radiated Emissions Test Results (Continued)

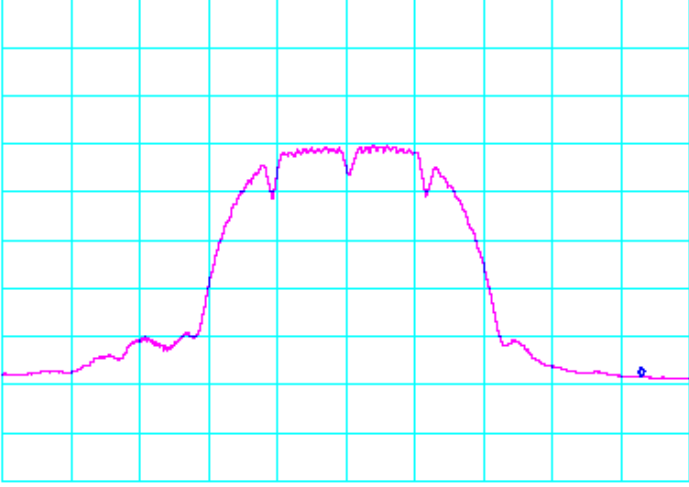
Plots Showing Out-Of-Band Emissions (Peak RBW=VBW=1MHz; Average RBW = 1MHz, VBW = 10Hz)

Test Date	Data	Test Eng.
03/20/07	2.462 GHz band edge PEAK DELTA (Vertical) (INTEL-070320-03a19)	BM
<p>*ATTEN 0dB MKR 29.67dBµV RL 97.0dBµV 10dB/ 2.48350GHz</p>  <p>CENTER 2.46200GHz SPAN 50.00MHz *RBW 1.0MHz *VBW 1.0MHz SWP 50.0ms</p>		
		
Test Date	Data	Test Eng.
03/20/07	2.462 GHz band edge AVERAGE DELTA (Vertical) (INTEL-070320-03a20)	BM
<p>*ATTEN 0dB MKR 18.67dBµV RL 97.0dBµV 10dB/ 2.48350GHz</p>  <p>CENTER 2.46200GHz SPAN 50.00MHz *RBW 1.0MHz *VBW 10Hz SWP 19.0sec</p>		
		



Radiated Emissions Test Results (Continued)

*Spurious Emissions Measurements in 802.11b mode (2400-2483.5 MHz)
 Channels 1, 6, & 11
 Continuous TX at Chain B Antenna port with Sony IRX-3980 Antennas
 Aegis Labs, Inc. File #: INTEL-070320-12*

RADIATED EMISSIONS - Horizontal Antenna Polarization												
Freq. (MHz)	Meter Reading (dBuV)	Antenna Height (cm)	Azimuth (degrees)	Quasi pk or AVG (dBuV)		Distance Factor (dB)	Cable Factor (dB)	Ant. Factor (dB)	Corrected Reading (dBuV)	Limits (dBuV)	Diff (dB) +=FAIL	Comments
2720.00	33.00	100	225			9.54	2.12	30.42	56.00	74.00	-18.00	Ch. 1
2720.00				21.15	A	9.54	2.12	30.42	44.15	54.00	-9.85	
2720.00	33.67	100	225			9.54	2.12	30.42	56.67	74.00	-17.33	Ch. 6
2720.00				21.75	A	9.54	2.12	30.42	44.75	54.00	-9.25	
2720.00	32.17	100	225			9.54	2.12	30.42	55.17	74.00	-18.83	Ch. 11
2720.00				18.48	A	9.54	2.12	30.42	41.48	54.00	-12.52	

RADIATED EMISSIONS - Vertical Antenna Polarization												
Freq. (MHz)	Meter Reading (dBuV)	Antenna Height (cm)	Azimuth (degrees)	Quasi pk or AVG (dBuV)		Distance Factor (dB)	Cable Factor (dB)	Ant. Factor (dB)	Corrected Reading (dBuV)	Limits (dBuV)	Diff (dB) +=FAIL	Comments
2720.00	32.67	100	180			9.54	2.12	29.96	55.21	74.00	-18.79	Ch. 1
2720.00				21.26	A	9.54	2.12	29.96	43.80	54.00	-10.20	
2720.00	33.33	100	180			9.54	2.12	29.96	55.87	74.00	-18.13	Ch. 6
2720.00				21.35	A	9.54	2.12	29.96	43.89	54.00	-10.11	
2720.00	33.00	100	180			9.54	2.12	29.96	55.54	74.00	-18.46	Ch. 11
2720.00				19.64	A	9.54	2.12	29.96	42.18	54.00	-11.82	



Spurious Radiated Emissions Test Results (Continued)

*Spurious Emissions Measurements in 802.11b mode (2400-2483.5 MHz)
Channels 1, 6, & 11
Continuous TX at Chain B Antenna port with Sony IRX-3980 Antennas
Aegis Labs, Inc. File #: INTEL-070320-08*

RADIATED EMISSIONS - Horizontal Antenna Polarization												
Freq. (MHz)	Meter Reading (dBuV)	Antenna Height (cm)	Azimuth (degrees)	Quasi pk or AVG (dBuV)		Preamp Factor (dB)	Cable Factor (dB)	Ant. Factor (dB)	Corrected Reading (dBuV)	Limits (dBuV)	Diff (dB) +=FAIL	Comments
4824.00	55.17	100	225			51.08	2.87	33.91	40.88	74.00	-33.12	Ch. 1
4824.00				46.35	A	51.08	2.87	33.91	32.06	54.00	-21.94	
9648.01	51.50	100	135			50.15	4.15	38.12	43.61	55.28	-11.67	
4873.99	54.50	100	180			51.12	2.89	34.02	40.29	74.00	-33.71	Ch. 6
4873.99				46.97	A	51.12	2.89	34.02	32.76	54.00	-21.24	
9747.96	52.00	100	225			50.19	4.18	38.20	44.19	55.85	-11.66	
4924.00	54.33	100	315			51.15	2.90	34.13	40.21	74.00	-33.79	Ch. 11
4924.00				46.30	A	51.15	2.90	34.13	32.18	54.00	-21.82	
9848.01	52.00	100	315			50.23	4.21	38.28	44.26	56.81	-12.55	

RADIATED EMISSIONS - Vertical Antenna Polarization												
Freq. (MHz)	Meter Reading (dBuV)	Antenna Height (cm)	Azimuth (degrees)	Quasi pk or AVG (dBuV)		Preamp Factor (dB)	Cable Factor (dB)	Ant. Factor (dB)	Corrected Reading (dBuV)	Limits (dBuV)	Diff (dB) +=FAIL	Comments
4824.01	56.00	100	225			51.08	2.87	33.78	41.58	74.00	-32.42	Ch. 1
4824.01				49.29	A	51.08	2.87	33.78	34.87	54.00	-19.13	
9648.01	52.50	100	270			50.15	4.15	38.09	44.59	52.16	-7.57	
4873.99	55.67	100	225			51.12	2.89	33.87	41.31	74.00	-32.69	Ch. 6
4873.99				48.89	A	51.12	2.89	33.87	34.53	54.00	-19.47	
9747.96	55.00	100	315			50.19	4.18	38.15	47.14	53.07	-5.93	
4924.05	54.83	100	225			51.15	2.90	33.96	40.54	74.00	-33.46	Ch. 11
4924.05				48.17	A	51.15	2.90	33.96	33.88	54.00	-20.12	
9848.06	53.00	100	135			50.23	4.21	38.21	45.19	55.33	-10.14	



Radiated Emissions Test Results (Continued)

*Spurious Emissions Measurements in 802.11b mode (2400-2483.5 MHz)
 Channels 1, 6, & 11
 Continuous RX at Chain B Antenna port with Sony IRX-3980 Antennas
 Aegis Labs, Inc. File #: INTEL-070320-08*

RADIATED EMISSIONS - Horizontal Antenna Polarization

Freq. (MHz)	Meter Reading (dBuV)	Antenna Height (cm)	Azimuth (degrees)	Quasi pk or AVG (dBuV)		Preamp Factor (dB)	Cable Factor (dB)	Ant. Factor (dB)	Corrected Reading (dBuV)	Limits (dBuV)	Diff (dB) +=FAIL	Comments
4824.00	53.00	100	225			51.08	2.87	33.91	38.71	74.00	-35.29	Ch. 1
4824.00				40.35	A	51.08	2.87	33.91	26.06	54.00	-27.94	
4874.00	53.50	100	225			51.12	2.89	34.02	39.29	74.00	-34.71	Ch. 6
4874.00				39.67	A	51.12	2.89	34.02	25.46	54.00	-28.54	
4924.00	52.67	100	225			51.15	2.90	34.13	38.55	74.00	-35.45	Ch. 11
4924.00				40.22	A	51.15	2.90	34.13	26.10	54.00	-27.90	

RADIATED EMISSIONS - Vertical Antenna Polarization

Freq. (MHz)	Meter Reading (dBuV)	Antenna Height (cm)	Azimuth (degrees)	Quasi pk or AVG (dBuV)		Preamp Factor (dB)	Cable Factor (dB)	Ant. Factor (dB)	Corrected Reading (dBuV)	Limits (dBuV)	Diff (dB) +=FAIL	Comments
4824.00	52.67	100	225			51.08	2.87	33.78	38.25	74.00	-35.75	Ch. 1
4824.00				40.16	A	51.08	2.87	33.78	25.74	54.00	-28.26	
4874.00	52.00	100	225			51.12	2.89	33.87	37.64	74.00	-36.36	Ch. 6
4874.00				39.64	A	51.12	2.89	33.87	25.28	54.00	-28.72	
4924.00	52.33	100	225			51.15	2.90	33.96	38.04	74.00	-35.96	Ch. 11
4924.00				40.03	A	51.15	2.90	33.96	25.74	54.00	-28.26	



RADIATED EMISSIONS TEST RESULTS

CLIENT:	Intel Corporation	DATE:	03/20/07
EUT:	Intel Wireless WiFi Link 4965AGN	PROJECT NUMBER:	INTEL-070320
MODEL NUMBER:	4965AGN	TEST ENGINEER:	BM/JC
SERIAL NUMBER:	0013E804612B	SITE #:	1
CONFIGURATION:	Tested installed in the host computer's mini PCI slot in 802.11g (2400-2483.5 MHz) mode with Sony IRX-3980 Antennas.	TEMPERATURE:	15 deg. C
		HUMIDITY:	52% RH
		TIME:	5:30 PM

Description:	Radiated RF Emissions (1 GHz – 18 GHz)
Results:	PASSED Horizontal and Vertical Antenna Polarizations Class B Limits
Note:	Radiated Emissions Measurements were performed on the EUT with power supply set at the following voltage and frequency. <ul style="list-style-type: none"> • 120VAC / 60 Hz.

Unwanted Spurious Emissions Limits			
Frequency (MHz)	Field Strength (uV/m)	Field Strength (dBuV/m) (Emissions in the restricted bands)	Field Strength (dBm/MHz) (Emissions outside the restricted bands)
Above 960	500	54.00 (Average) 74.00 (Peak)	< -20 dBc

Radiated Emissions Sample Calculations

$$\text{Corrected Meter Reading} = \text{Meter Reading} + F + C - D$$

Where, F = Antenna Factor

C = Cable Factor

G = Amplifier Gain

D = Distance Factor (if applicable)

Therefore, the equation for determining the Corrected Meter Reading Limit (CML) is:

$$\text{CML} = \text{Specification Limit} - F - C + D$$



Radiated Emissions Test Results (Continued)

*Fundamental Measurements in 802.11g mode (2400-2483.5 MHz)
 Channels 1, 6, & 11
 Continuous TX at Chain A Antenna port with Sony IRX-3980 Antennas
 Aegis Labs, Inc. File #: INTEL-070320-02*

RADIATED EMISSIONS - Horizontal Antenna Polarization												
Freq. (MHz)	Meter Reading (dBuV)	Antenna Height (cm)	Azimuth (degrees)	Quasi pk or AVG (dBuV)		Distance Factor (dB)	Cable Factor (dB)	Ant. Factor (dB)	Corrected Reading (dBuV)	Limits (dBuV)	Diff (dB) +=FAIL	Comments
2412.00	56.00	100	225			9.54	1.99	29.50	77.95			Ch. 1
2412.00				43.50	A	9.54	1.99	29.50	65.45			
2437.00	56.83	100	225			9.54	2.00	29.59	78.88			Ch. 6
2437.00				44.17	A	9.54	2.00	29.59	66.22			
2462.00	57.17	100	225			9.54	2.01	29.67	79.31			Ch. 11
2462.00				44.33	A	9.54	2.01	29.67	66.47			

RADIATED EMISSIONS - Vertical Antenna Polarization												
Freq. (MHz)	Meter Reading (dBuV)	Antenna Height (cm)	Azimuth (degrees)	Quasi pk or AVG (dBuV)		Distance Factor (dB)	Cable Factor (dB)	Ant. Factor (dB)	Corrected Reading (dBuV)	Limits (dBuV)	Diff (dB) +=FAIL	Comments
2412.00	60.83	100	225			9.54	1.99	29.04	82.32			Ch. 1
2412.00				47.33	A	9.54	1.99	29.04	68.82			
2437.00	57.50	100	225			9.54	2.00	29.11	79.07			Ch. 6
2437.00				44.17	A	9.54	2.00	29.11	65.74			
2462.00	59.33	100	225			9.54	2.01	29.19	80.99			Ch. 11
2462.00				46.00	A	9.54	2.01	29.19	67.66			

NOTE: Fundamental signals measured at 1 meter and extrapolated to 3 meters to calculate the radiated band edge field strengths.



Radiated Emissions Test Results (Continued)

*Band Edge Field Strength Measurements in 802.11g mode (2400-2483.5 MHz)
 Channels 1 & 11
 Continuous TX at Chain A Antenna port with Sony IRX-3980 Antennas
 Aegis Labs, Inc. File #: INTEL-070320-02*

RADIATED EMISSIONS - Horizontal Antenna Polarization												
Freq. (MHz)	Meter Reading (dBuV)	Antenna Height (cm)	Azimuth (degrees)	Quasi pk or AVG (dBuV)		Distance Factor (dB)	Cable Factor (dB)	Ant. Factor (dB)	Corrected Reading (dBuV)	Limits (dBuV)	Diff (dB) +=FAIL	Comments
2390.00	30.83	100	225			9.54	1.98	29.43	52.70	74.00	-21.30	Ch. 1
2390.00				18.33	A	9.54	1.98	29.43	40.20	54.00	-13.80	
2400.00	34.50	100	225			9.54	1.98	29.46	56.40	57.95	-1.55	
2483.50	29.50	100	225			9.54	2.02	29.74	51.73	74.00	-22.27	Ch. 11
2483.50				18.50	A	9.54	2.02	29.74	40.73	54.00	-13.27	

RADIATED EMISSIONS - Vertical Antenna Polarization												
Freq. (MHz)	Meter Reading (dBuV)	Antenna Height (cm)	Azimuth (degrees)	Quasi pk or AVG (dBuV)		Distance Factor (dB)	Cable Factor (dB)	Ant. Factor (dB)	Corrected Reading (dBuV)	Limits (dBuV)	Diff (dB) +=FAIL	Comments
2390.00	30.67	100	225			9.54	1.98	28.97	52.08	74.00	-21.92	Ch. 1
2390.00				18.67	A	9.54	1.98	28.97	40.08	54.00	-13.92	
2400.00	38.17	100	225			9.54	1.98	29.00	59.61	62.32	-2.70	
2483.50	31.17	100	225			9.54	2.02	29.25	52.90	74.00	-21.10	Ch. 11
2483.50				18.50	A	9.54	2.02	29.25	40.23	54.00	-13.77	

NOTE: The “Band Edge Field Strength” was calculated using the “Radiated Fundamental” measurements.



Radiated Emissions Test Results (Continued)

Plots Showing Out-Of-Band Emissions (Peak RBW=VBW=1MHz; Average RBW = 1MHz, VBW = 10Hz)

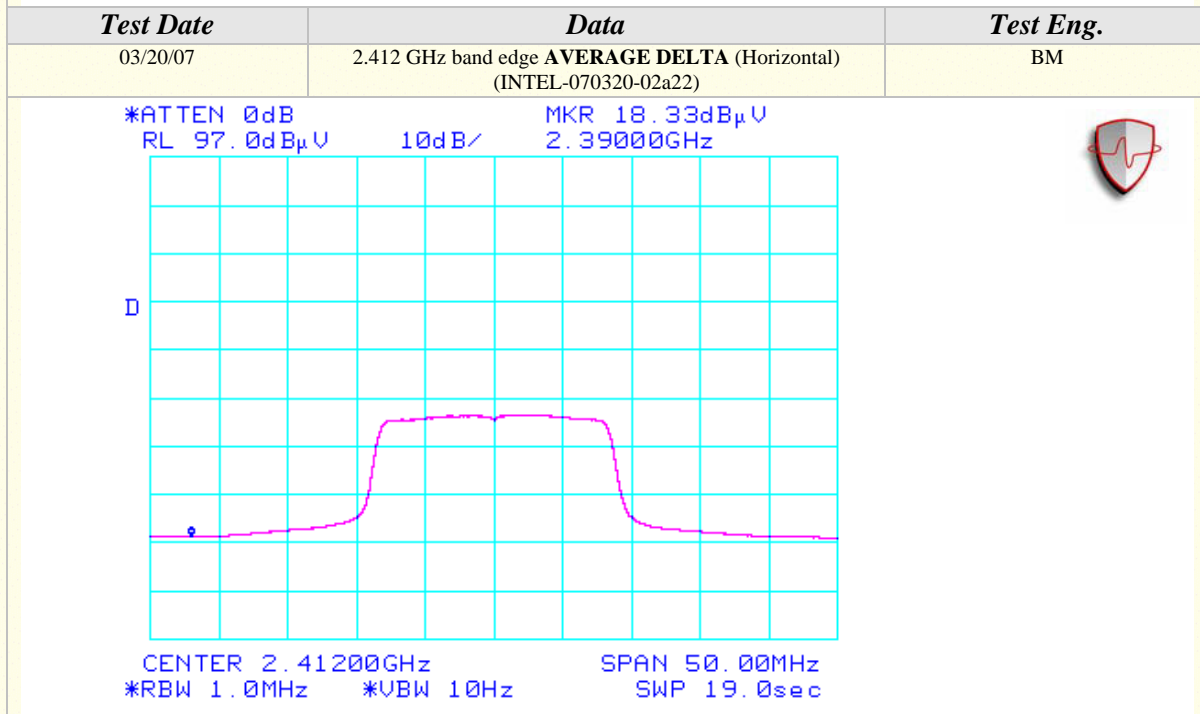
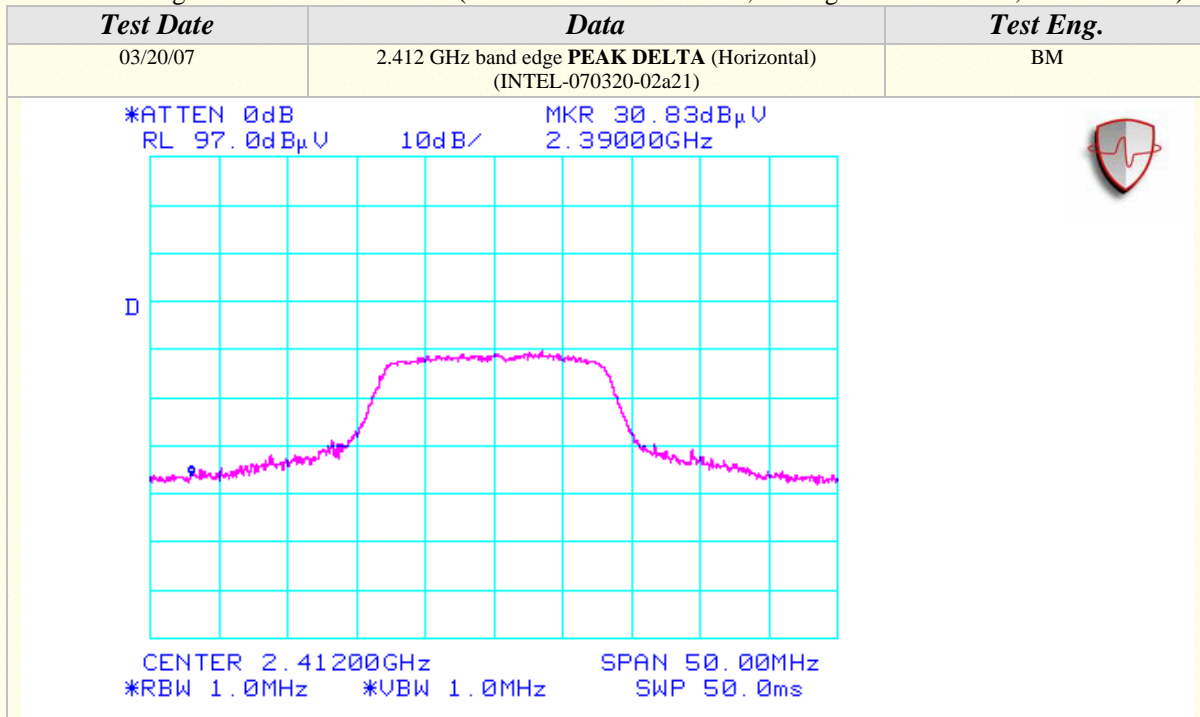

Radiated Emissions Test Results (Continued)

Plots Showing Out-Of-Band Emissions (Peak RBW=VBW=1MHz; Average RBW = 1MHz, VBW = 10Hz)

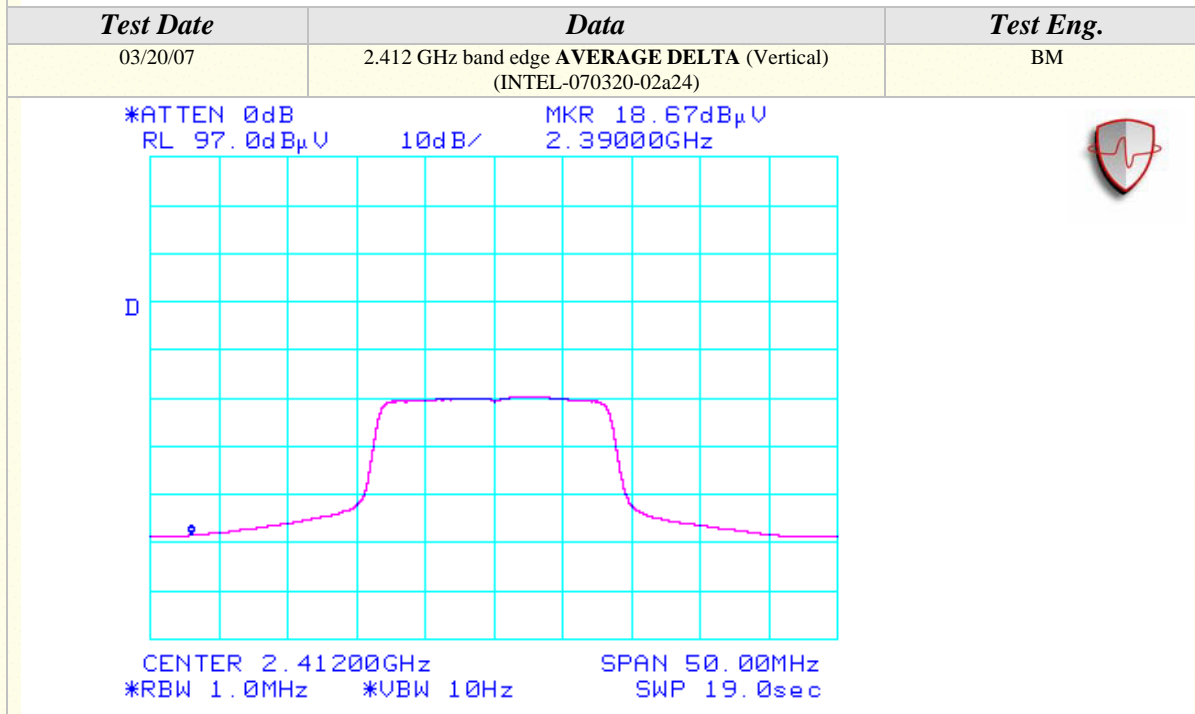
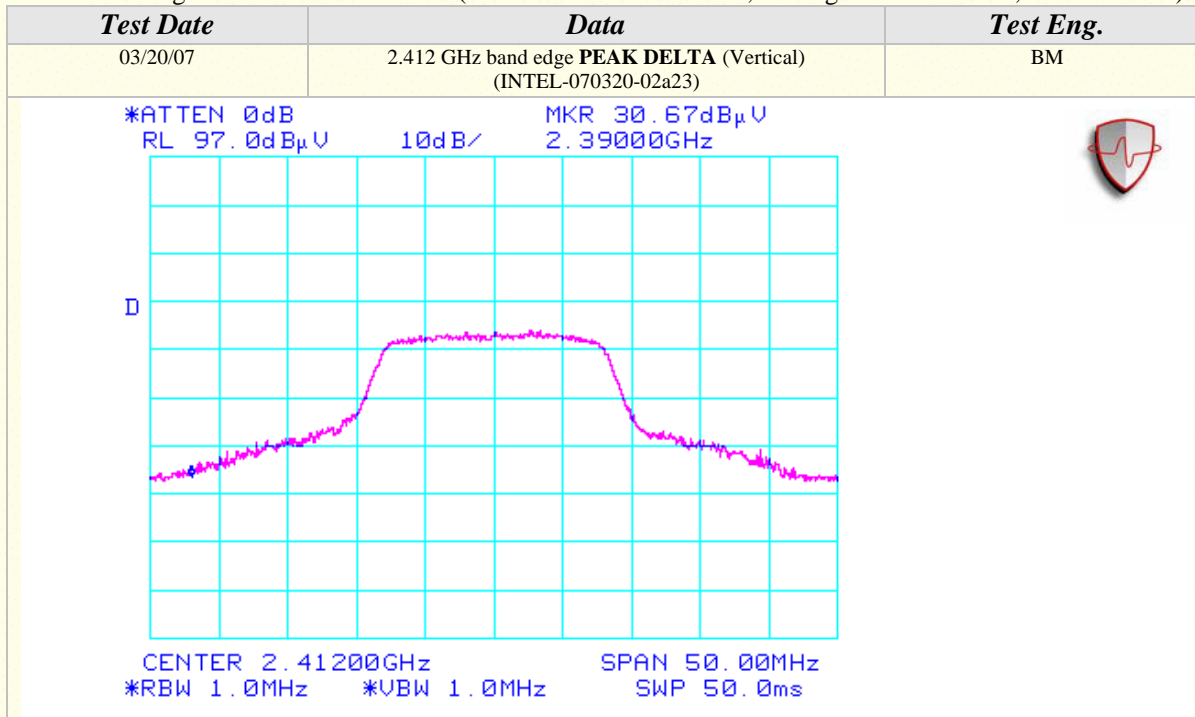

Radiated Emissions Test Results (Continued)

Plots Showing Out-Of-Band Emissions (Peak RBW=VBW=1MHz; Average RBW = 1MHz, VBW = 10Hz)

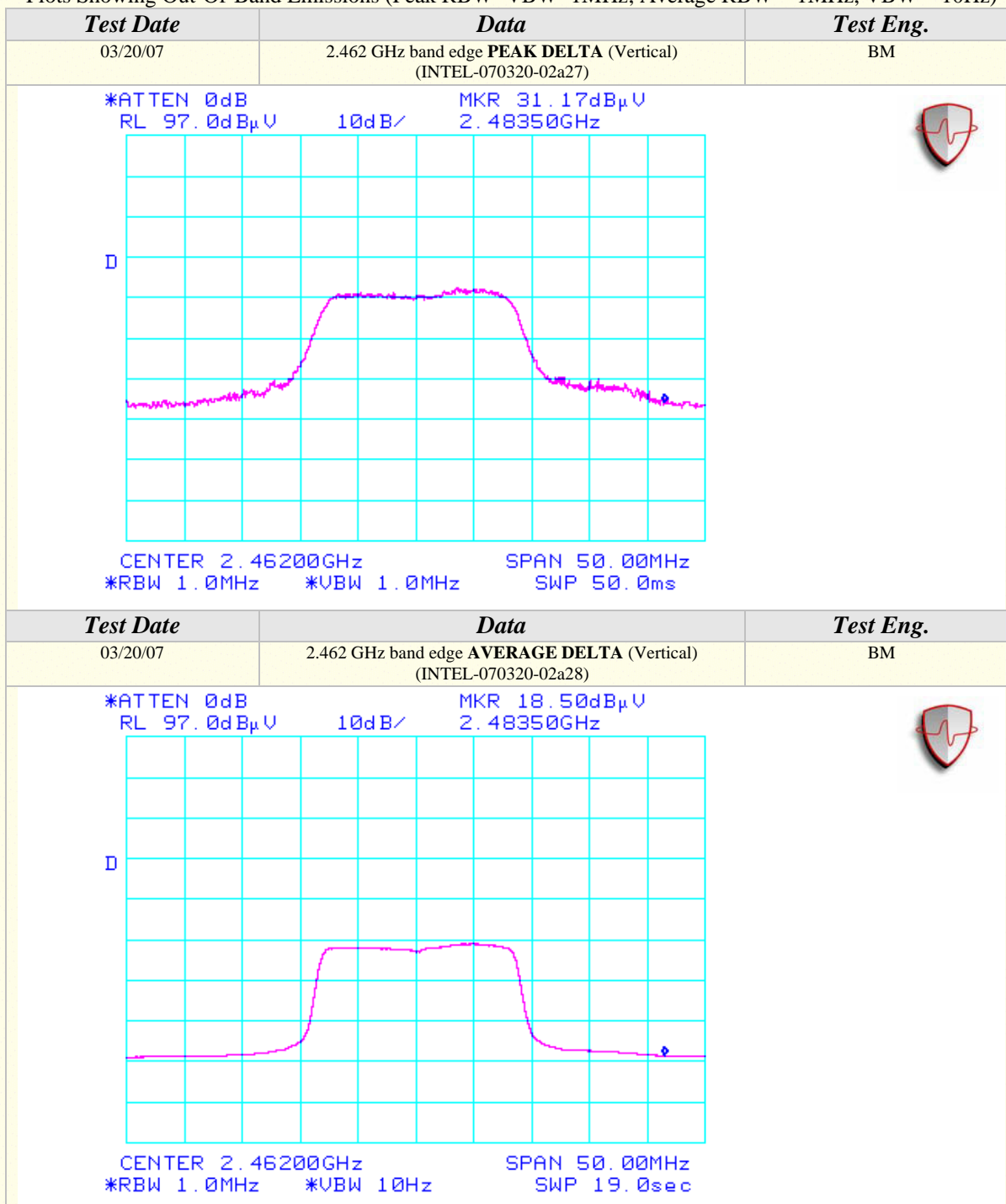



Radiated Emissions Test Results (Continued)

*Spurious Emissions Measurements in 802.11g mode (2400-2483.5 MHz)
Channels 1, 6, & 11
Continuous TX at Chain A Antenna port with Sony IRX-3980 Antennas
Aegis Labs, Inc. File #: INTEL-070320-12*

RADIATED EMISSIONS - Horizontal Antenna Polarization												
Freq. (MHz)	Meter Reading (dBuV)	Antenna Height (cm)	Azimuth (degrees)	Quasi pk or AVG (dBuV)		Distance Factor (dB)	Cable Factor (dB)	Ant. Factor (dB)	Corrected Reading (dBuV)	Limits (dBuV)	Diff (dB) +=FAIL	Comments
2720.00	33.17	100	225			9.54	2.12	30.42	56.17	74.00	-17.83	Ch. 1
2720.00				21.54	A	9.54	2.12	30.42	44.54	54.00	-9.46	
2720.00	32.83	100	225			9.54	2.12	30.42	55.83	74.00	-18.17	Ch. 6
2720.00				20.32	A	9.54	2.12	30.42	43.32	54.00	-10.68	
2720.00	33.33	100	225			9.54	2.12	30.42	56.33	74.00	-17.67	Ch. 11
2720.00				21.88	A	9.54	2.12	30.42	44.88	54.00	-9.12	

RADIATED EMISSIONS - Vertical Antenna Polarization												
Freq. (MHz)	Meter Reading (dBuV)	Antenna Height (cm)	Azimuth (degrees)	Quasi pk or AVG (dBuV)		Distance Factor (dB)	Cable Factor (dB)	Ant. Factor (dB)	Corrected Reading (dBuV)	Limits (dBuV)	Diff (dB) +=FAIL	Comments
2720.00	33.50	100	225			9.54	2.12	29.96	56.04	74.00	-17.96	Ch. 1
2720.00				22.14	A	9.54	2.12	29.96	44.68	54.00	-9.32	
2720.00	33.67	100	225			9.54	2.12	29.96	56.21	74.00	-17.79	Ch. 6
2720.00				22.27	A	9.54	2.12	29.96	44.81	54.00	-9.19	
2720.00	32.83	100	225			9.54	2.12	29.96	55.37	74.00	-18.63	Ch. 11
2720.00				20.59	A	9.54	2.12	29.96	43.13	54.00	-10.87	



Radiated Emissions Test Results (Continued)

*Spurious Emissions Measurements in 802.11g mode (2400-2483.5 MHz)
 Channels 1, 6, & 11
 Continuous TX at Chain A Antenna port with Sony IRX-3980 Antennas
 Aegis Labs, Inc. File #: INTEL-070320-07*

RADIATED EMISSIONS - Horizontal Antenna Polarization

Freq. (MHz)	Meter Reading (dBuV)	Antenna Height (cm)	Azimuth (degrees)	Quasi pk or AVG (dBuV)		Preamp Factor (dB)	Cable Factor (dB)	Ant. Factor (dB)	Corrected Reading (dBuV)	Limits (dBuV)	Diff (dB) +=FAIL	Comments
4824.00	59.83	100	225			51.08	2.87	33.91	45.54	74.00	-28.46	Ch. 1
4824.00				46.79	A	51.08	2.87	33.91	32.50	54.00	-21.50	
4873.99	59.00	100	225			51.12	2.89	34.02	44.79	74.00	-29.21	Ch. 6
4873.99				46.16	A	51.12	2.89	34.02	31.95	54.00	-22.05	
4924.00	60.67	100	225			51.15	2.90	34.13	46.55	74.00	-27.45	Ch. 11
4924.00				47.52	A	51.15	2.90	34.13	33.40	54.00	-20.60	

RADIATED EMISSIONS - Vertical Antenna Polarization

Freq. (MHz)	Meter Reading (dBuV)	Antenna Height (cm)	Azimuth (degrees)	Quasi pk or AVG (dBuV)		Preamp Factor (dB)	Cable Factor (dB)	Ant. Factor (dB)	Corrected Reading (dBuV)	Limits (dBuV)	Diff (dB) +=FAIL	Comments
4824.01	57.83	100	135			51.08	2.87	33.78	43.41	74.00	-30.59	Ch. 1
4824.01				44.58	A	51.08	2.87	33.78	30.16	54.00	-23.84	
9647.62	58.33	100	180			50.15	4.15	38.09	50.41	62.32	-11.91	
4873.99	59.00	100	135			51.12	2.89	33.87	44.64	74.00	-29.36	Ch. 6
4873.99				45.79	A	51.12	2.89	33.87	31.43	54.00	-22.57	
9747.96	60.00	100	180			50.19	4.18	38.15	52.14	59.07	-6.93	
4924.05	57.17	100	135			51.15	2.90	33.96	42.88	74.00	-31.12	Ch. 11
4924.05				43.83	A	51.15	2.90	33.96	29.54	54.00	-24.46	
9848.06	58.67	100	180			50.23	4.21	38.21	50.86	60.99	-10.13	



Radiated Emissions Test Results (Continued)

*Fundamental Measurements in 802.11g mode (2400-2483.5 MHz)
 Channels 1, 6, & 11
 Continuous TX at Chain B Antenna port with Sony IRX-3980 Antennas
 Aegis Labs, Inc. File #: INTEL-070320-03*

RADIATED EMISSIONS - Horizontal Antenna Polarization												
<i>Freq. (MHz)</i>	<i>Meter Reading (dBuV)</i>	<i>Antenna Height (cm)</i>	<i>Azimuth (degrees)</i>	<i>Quasi pk or AVG (dBuV)</i>		<i>Distance Factor (dB)</i>	<i>Cable Factor (dB)</i>	<i>Ant. Factor (dB)</i>	<i>Corrected Reading (dBuV)</i>	<i>Limits (dBuV)</i>	<i>Diff (dB) +=FAIL</i>	<i>Comments</i>
2412.00	77.67	100	180			9.54	1.99	29.50	99.62			Ch. 1
2412.00				63.17	A	9.54	1.99	29.50	85.12			
2437.00	80.00	100	225			9.54	2.00	29.59	102.05			Ch. 6
2437.00				65.17	A	9.54	2.00	29.59	87.22			
2462.00	77.33	100	180			9.54	2.01	29.67	99.47			Ch. 11
2462.00				63.00	A	9.54	2.01	29.67	85.14			

RADIATED EMISSIONS - Vertical Antenna Polarization												
<i>Freq. (MHz)</i>	<i>Meter Reading (dBuV)</i>	<i>Antenna Height (cm)</i>	<i>Azimuth (degrees)</i>	<i>Quasi pk or AVG (dBuV)</i>		<i>Distance Factor (dB)</i>	<i>Cable Factor (dB)</i>	<i>Ant. Factor (dB)</i>	<i>Corrected Reading (dBuV)</i>	<i>Limits (dBuV)</i>	<i>Diff (dB) +=FAIL</i>	<i>Comments</i>
2412.00	77.17	100	135			9.54	1.99	29.04	98.66			Ch. 1
2412.00				62.67	A	9.54	1.99	29.04	84.16			
2437.00	75.83	100	225			9.54	2.00	29.11	97.40			Ch. 6
2437.00				61.50	A	9.54	2.00	29.11	83.07			
2462.00	73.83	100	135			9.54	2.01	29.19	95.49			Ch. 11
2462.00				60.00	A	9.54	2.01	29.19	81.66			

NOTE: Fundamental signals measured at 1 meter and extrapolated to 3 meters to calculate the radiated band edge field strengths.



Radiated Emissions Test Results (Continued)

*Band Edge Field Strength Measurements in 802.11g mode (2400-2483.5 MHz)
 Channels 1 & 11
 Continuous TX at Chain B Antenna port with Sony IRX-3980 Antennas
 Aegis Labs, Inc. File #: INTEL-070320-03*



RADIATED EMISSIONS - Horizontal Antenna Polarization												
Freq. (MHz)	Meter Reading (dBuV)	Antenna Height (cm)	Azimuth (degrees)	Quasi pk or AVG (dBuV)		Distance Factor (dB)	Cable Factor (dB)	Ant. Factor (dB)	Corrected Reading (dBuV)	Limits (dBuV)	Diff (dB) +=FAIL	Comments
2390.00	45.17	100	180			9.54	1.98	29.43	67.04	74.00	-6.96	Ch. 1
2390.00				27.00	A	9.54	1.98	29.43	48.87	54.00	-5.13	
2400.00	55.50	100	180			9.54	1.98	29.46	77.40	79.62	-2.22	
2483.50	43.17	100	180			9.54	2.02	29.74	65.40	74.00	-8.60	Ch. 11
2483.50				24.17	A	9.54	2.02	29.74	46.40	54.00	-7.60	

RADIATED EMISSIONS - Vertical Antenna Polarization												
Freq. (MHz)	Meter Reading (dBuV)	Antenna Height (cm)	Azimuth (degrees)	Quasi pk or AVG (dBuV)		Distance Factor (dB)	Cable Factor (dB)	Ant. Factor (dB)	Corrected Reading (dBuV)	Limits (dBuV)	Diff (dB) +=FAIL	Comments
2390.00	45.83	100	135			9.54	1.98	28.97	67.24	74.00	-6.76	Ch. 1
2390.00				24.67	A	9.54	1.98	28.97	46.08	54.00	-7.92	
2400.00	55.00	100	135			9.54	1.98	29.00	76.44	78.66	-2.21	
2483.50	44.50	100	135			9.54	2.02	29.25	66.23	74.00	-7.77	Ch. 11
2483.50				23.00	A	9.54	2.02	29.25	44.73	54.00	-9.27	

NOTE: The “Band Edge Field Strength” was calculated using the “Radiated Fundamental” measurements.

Radiated Emissions Test Results (Continued)

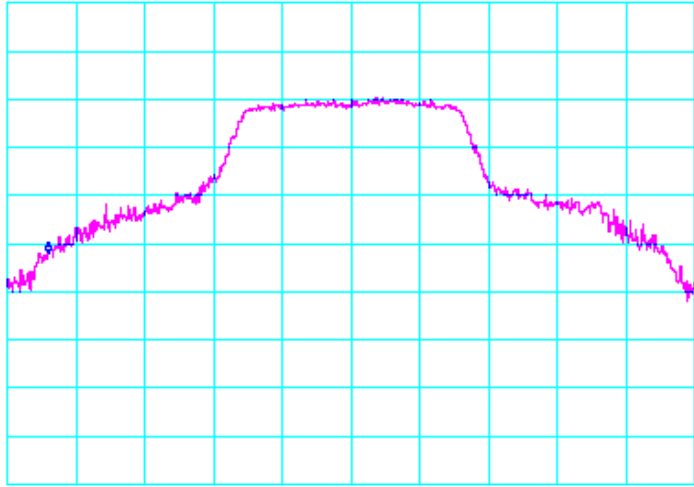
Plots Showing Out-Of-Band Emissions (Peak RBW=VBW=1MHz; Average RBW = 1MHz, VBW = 10Hz)

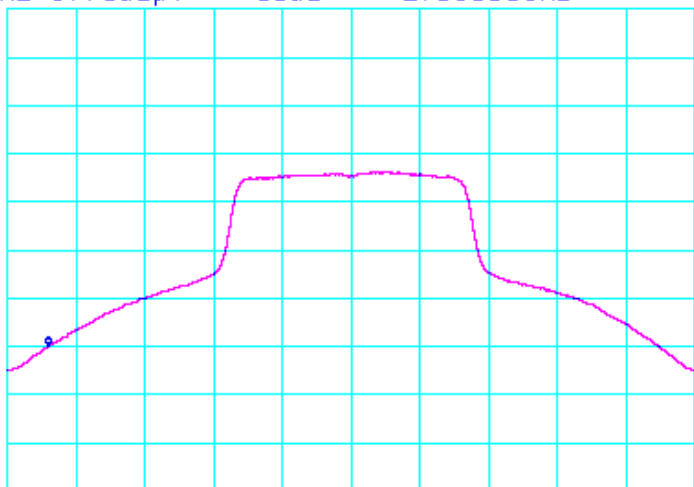
Test Date	Data	Test Eng.
03/20/07	2.412 GHz band edge PEAK DELTA (Horizontal) (INTEL-070320-03a21)	BM
<div style="display: flex; justify-content: space-between;"> <div data-bbox="324 420 974 472"> <p>*ATTEN 0dB MKR 45.17dBμV RL 97.0dBμV 10dB/ 2.39000GHz</p> </div> <div data-bbox="1282 430 1364 514" style="text-align: right;">  </div> </div> <div style="text-align: center; margin: 10px 0;">  </div> <div style="display: flex; justify-content: space-between;"> <div data-bbox="324 955 747 1018"> <p>CENTER 2.41200GHz *RBW 1.0MHz *UBW 1.0MHz</p> </div> <div data-bbox="795 955 1023 1018"> <p>SPAN 50.00MHz SWP 50.0ms</p> </div> </div>		
Test Date	Data	Test Eng.
03/20/07	2.412 GHz band edge AVERAGE DELTA (Horizontal) (INTEL-070320-03a22)	BM
<div style="display: flex; justify-content: space-between;"> <div data-bbox="324 1123 974 1176"> <p>*ATTEN 0dB MKR 27.00dBμV RL 97.0dBμV 10dB/ 2.39000GHz</p> </div> <div data-bbox="1282 1144 1364 1228" style="text-align: right;">  </div> </div> <div style="text-align: center; margin: 10px 0;">  </div> <div style="display: flex; justify-content: space-between;"> <div data-bbox="324 1669 747 1732"> <p>CENTER 2.41200GHz *RBW 1.0MHz *UBW 10Hz</p> </div> <div data-bbox="795 1669 1023 1732"> <p>SPAN 50.00MHz SWP 19.0sec</p> </div> </div>		

Radiated Emissions Test Results (Continued)

Plots Showing Out-Of-Band Emissions (Peak RBW=VBW=1MHz; Average RBW = 1MHz, VBW = 10Hz)

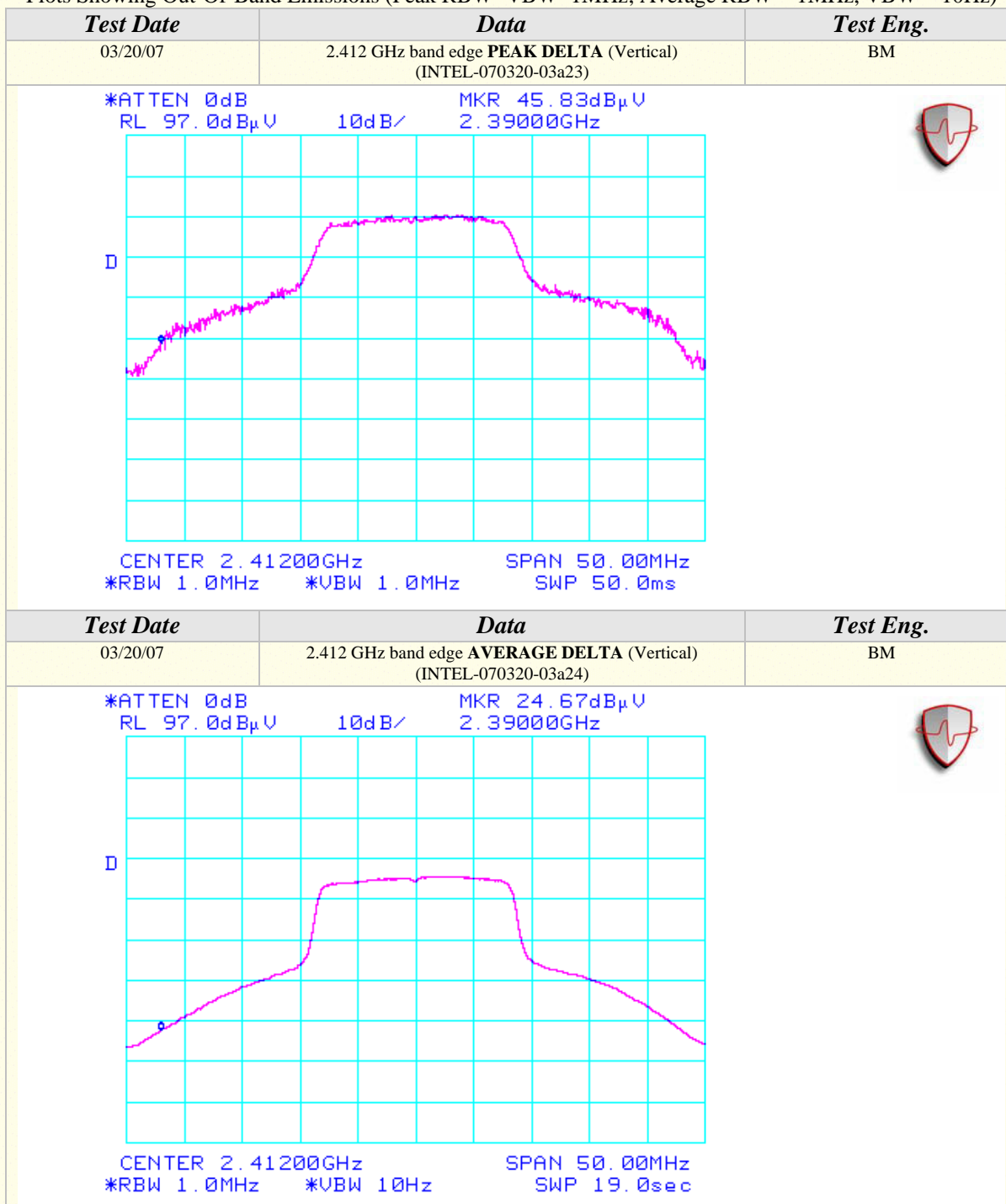

Radiated Emissions Test Results (Continued)

Plots Showing Out-Of-Band Emissions (Peak RBW=VBW=1MHz; Average RBW = 1MHz, VBW = 10Hz)

Test Date	Data	Test Eng.
03/20/07	2.462 GHz band edge PEAK DELTA (Horizontal) (INTEL-070320-03a25)	BM
<p>*ATTEN 0dB MKR 43.17dBμV RL 97.0dBμV 10dB/ 2.48350GHz</p> <p>CENTER 2.46200GHz SPAN 50.00MHz *RBW 1.0MHz *UBW 1.0MHz SWP 50.0ms</p>		
Test Date	Data	Test Eng.
03/20/07	2.462 GHz band edge AVERAGE DELTA (Horizontal) (INTEL-070320-03a26)	BM
<p>*ATTEN 0dB MKR 24.17dBμV RL 97.0dBμV 10dB/ 2.48350GHz</p> <p>CENTER 2.46200GHz SPAN 50.00MHz *RBW 1.0MHz *UBW 10Hz SWP 19.0sec</p>		

Radiated Emissions Test Results (Continued)

Plots Showing Out-Of-Band Emissions (Peak RBW=VBW=1MHz; Average RBW = 1MHz, VBW = 10Hz)

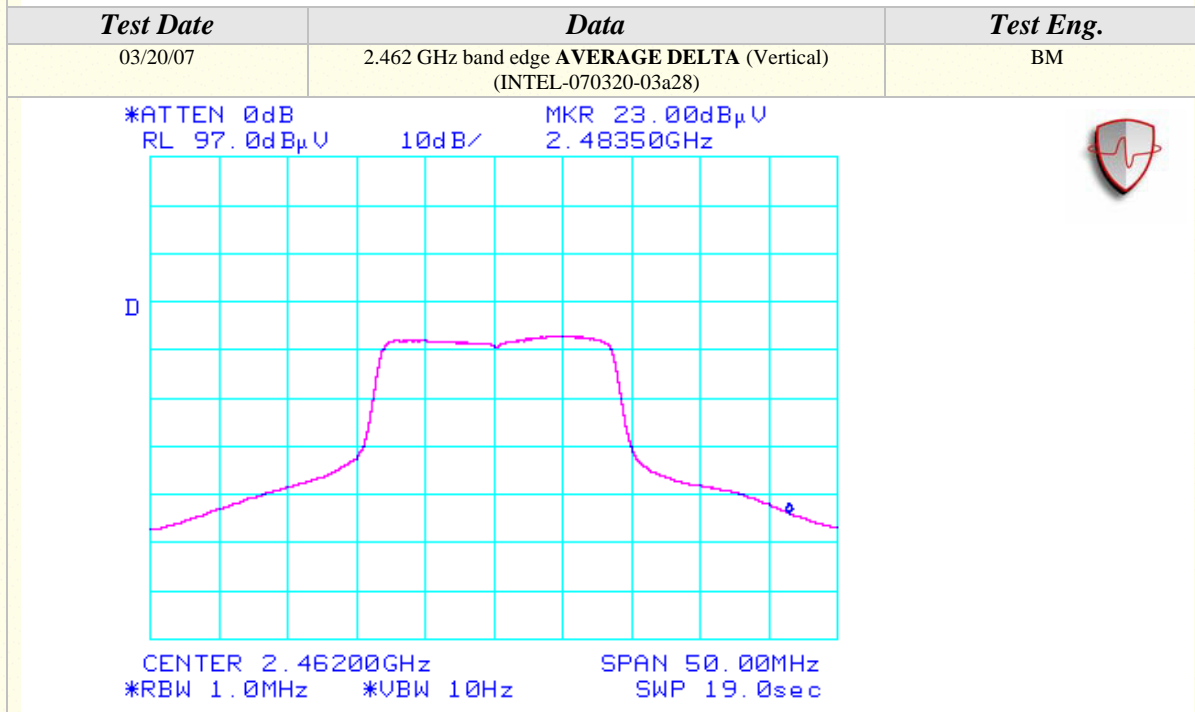
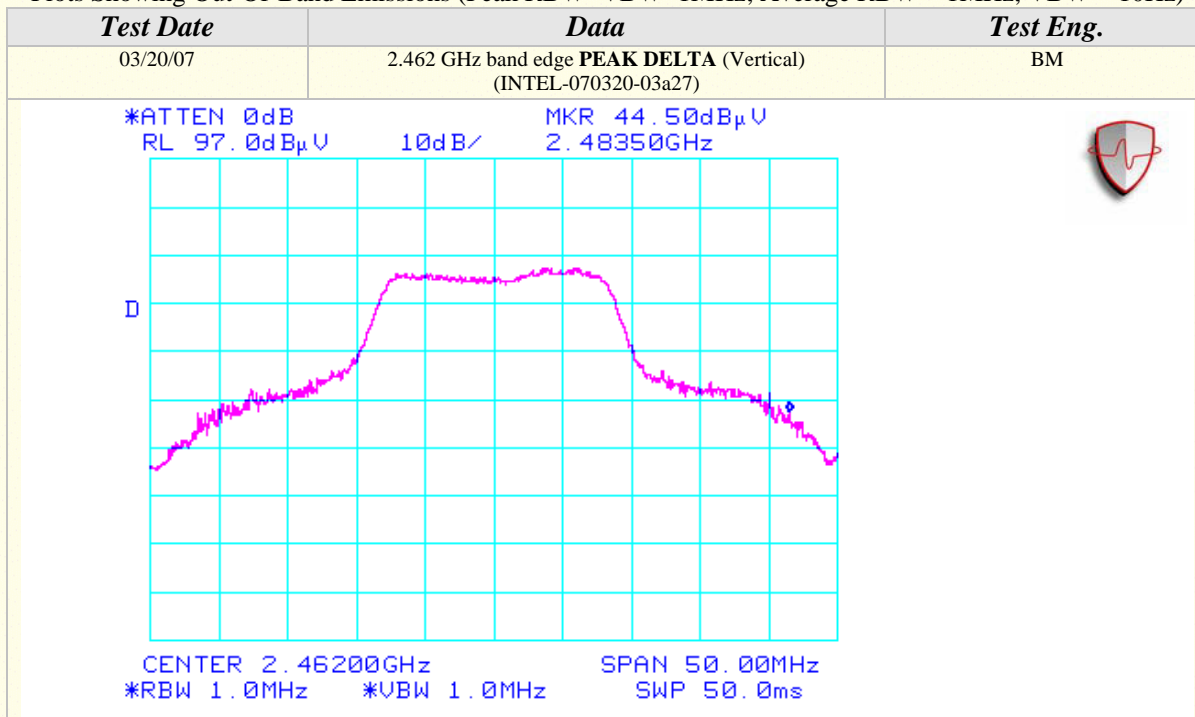



Radiated Emissions Test Results (Continued)

*Spurious Emissions Measurements in 802.11g mode (2400-2483.5 MHz)
Channels 1, 6, & 11
Continuous TX at Chain B Antenna port with Sony IRX-3980 Antennas
Aegis Labs, Inc. File #: INTEL-070320-12*

RADIATED EMISSIONS - Horizontal Antenna Polarization												
Freq. (MHz)	Meter Reading (dBuV)	Antenna Height (cm)	Azimuth (degrees)	Quasi pk or AVG (dBuV)		Distance Factor (dB)	Cable Factor (dB)	Ant. Factor (dB)	Corrected Reading (dBuV)	Limits (dBuV)	Diff (dB) +=FAIL	Comments
2720.00	32.67	100	225			9.54	2.12	30.42	55.67	74.00	-18.33	Ch. 1
2720.00				19.60	A	9.54	2.12	30.42	42.60	54.00	-11.40	
2720.00	32.50	100	225			9.54	2.12	30.42	55.50	74.00	-18.50	Ch. 6
2720.00				19.18	A	9.54	2.12	30.42	42.18	54.00	-11.82	
2720.00	32.67	100	225			9.54	2.12	30.42	55.67	74.00	-18.33	Ch. 11
2720.00				17.92	A	9.54	2.12	30.42	40.92	54.00	-13.08	

RADIATED EMISSIONS - Vertical Antenna Polarization												
Freq. (MHz)	Meter Reading (dBuV)	Antenna Height (cm)	Azimuth (degrees)	Quasi pk or AVG (dBuV)		Distance Factor (dB)	Cable Factor (dB)	Ant. Factor (dB)	Corrected Reading (dBuV)	Limits (dBuV)	Diff (dB) +=FAIL	Comments
2720.00	32.50	100	180			9.54	2.12	29.96	55.04	74.00	-18.96	Ch. 1
2720.00				19.04	A	9.54	2.12	29.96	41.58	54.00	-12.42	
2720.00	32.33	100	180			9.54	2.12	29.96	54.87	74.00	-19.13	Ch. 6
2720.00				19.77	A	9.54	2.12	29.96	42.31	54.00	-11.69	
2720.00	32.17	100	180			9.54	2.12	29.96	54.71	74.00	-19.29	Ch. 11
2720.00				18.59	A	9.54	2.12	29.96	41.13	54.00	-12.87	



Radiated Emissions Test Results (Continued)

*Spurious Emissions Measurements in 802.11g mode (2400-2483.5 MHz)
 Channels 1, 6, & 11
 Continuous TX at Chain B Antenna port with Sony IRX-3980 Antennas
 Aegis Labs, Inc. File #: INTEL-070320-08*

RADIATED EMISSIONS - Horizontal Antenna Polarization

Freq. (MHz)	Meter Reading (dBuV)	Antenna Height (cm)	Azimuth (degrees)	Quasi pk or AVG (dBuV)	Preamp Factor (dB)	Cable Factor (dB)	Ant. Factor (dB)	Corrected Reading (dBuV)	Limits (dBuV)	Diff (dB) +=FAIL	Comments
9648.00	51.33	100	135		50.15	4.15	38.12	43.44	59.78	-16.34	Ch. 1
3249.32	53.50	100	135		50.87	2.34	31.80	36.77	63.22	-26.45	Ch. 6
9848.01	51.17	100	135		50.23	4.21	38.28	43.43	61.81	-18.38	Ch. 11

RADIATED EMISSIONS - Vertical Antenna Polarization

Freq. (MHz)	Meter Reading (dBuV)	Antenna Height (cm)	Azimuth (degrees)	Quasi pk or AVG (dBuV)	Preamp Factor (dB)	Cable Factor (dB)	Ant. Factor (dB)	Corrected Reading (dBuV)	Limits (dBuV)	Diff (dB) +=FAIL	Comments
9647.62	50.83	100	135		50.15	4.15	38.09	42.91	57.49	-14.58	Ch. 1
3248.97	51.67	100	135		50.87	2.34	31.35	34.49	62.24	-27.75	Ch. 6
9848.28	54.00	100	135		50.23	4.21	38.21	46.19	61.16	-14.97	Ch. 11



RADIATED EMISSIONS TEST RESULTS

CLIENT:	Intel Corporation	DATE:	03/21/07
EUT:	Intel Wireless WiFi Link 4965AGN	PROJECT NUMBER:	INTEL-070320
MODEL NUMBER:	4965AGN	TEST ENGINEER:	BM/JC
SERIAL NUMBER:	0013E804612B	SITE #:	1
CONFIGURATION:	Tested installed in the host computer's mini PCI slot in 802.11n (2400-2483.5 MHz) mode 20MHz Wide with Sony IRX-3980 Antennas.	TEMPERATURE:	10 deg. C
		HUMIDITY:	62% RH
		TIME:	7:00 PM

Description:	Radiated RF Emissions (1 GHz – 18 GHz)
Results:	PASSED Horizontal and Vertical Antenna Polarizations Class B Limits
Note:	Radiated Emissions Measurements were performed on the EUT with power supply set at the following voltage and frequency. <ul style="list-style-type: none"> • 120VAC / 60 Hz.

Unwanted Spurious Emissions Limits			
Frequency (MHz)	Field Strength (uV/m)	Field Strength (dBuV/m) (Emissions in the restricted bands)	Field Strength (dBm/MHz) (Emissions outside the restricted bands)
Above 960	500	54.00 (Average) 74.00 (Peak)	< -20 dBc

Radiated Emissions Sample Calculations

$$\text{Corrected Meter Reading} = \text{Meter Reading} + F + C - D$$

Where, F = Antenna Factor

C = Cable Factor

G = Amplifier Gain

D = Distance Factor (if applicable)

Therefore, the equation for determining the Corrected Meter Reading Limit (CML) is:

$$\text{CML} = \text{Specification Limit} - F - C + D$$



Radiated Emissions Test Results (Continued)

*Fundamental Measurements in 802.11n mode 20MHz Wide (2400-2483.5 MHz)
 Channels 1, 6, & 11
 Continuous TX at Chain A Antenna port with Sony IRX-3980 Antennas
 Aegis Labs, Inc. File #: INTEL-070320-04*

RADIATED EMISSIONS - Horizontal Antenna Polarization												
Freq. (MHz)	Meter Reading (dBuV)	Antenna Height (cm)	Azimuth (degrees)	Quasi pk or AVG (dBuV)		Distance Factor (dB)	Cable Factor (dB)	Ant. Factor (dB)	Corrected Reading (dBuV)	Limits (dBuV)	Diff (dB) +=FAIL	Comments
2412.00	75.50	100	135			9.54	1.99	29.50	97.45			Ch. 1
2412.00				61.83	A	9.54	1.99	29.50	83.78			
2437.00	57.67	100	135			9.54	2.00	29.59	79.72			Ch. 6
2437.00				44.00	A	9.54	2.00	29.59	66.05			
2462.00	75.83	100	225			9.54	2.01	29.67	97.97			Ch. 11
2462.00				60.67	A	9.54	2.01	29.67	82.81			

RADIATED EMISSIONS - Vertical Antenna Polarization												
Freq. (MHz)	Meter Reading (dBuV)	Antenna Height (cm)	Azimuth (degrees)	Quasi pk or AVG (dBuV)		Distance Factor (dB)	Cable Factor (dB)	Ant. Factor (dB)	Corrected Reading (dBuV)	Limits (dBuV)	Diff (dB) +=FAIL	Comments
2412.00	80.00	100	225			9.54	1.99	29.04	101.49			Ch. 1
2412.00				63.33	A	9.54	1.99	29.04	84.82			
2437.00	57.83	125	135			9.54	2.00	29.11	79.40			Ch. 6
2437.00				43.67	A	9.54	2.00	29.11	65.24			
2462.00	74.50	100	225			9.54	2.01	29.19	96.16			Ch. 11
2462.00				59.67	A	9.54	2.01	29.19	81.33			

NOTE: Fundamental signals measured at 1 meter and extrapolated to 3 meters to calculate the radiated band edge field strengths.



Radiated Emissions Test Results (Continued)

*Band Edge Field Strength Measurements in 802.11n mode 20MHz Wide (2400-2483.5 MHz)
 Channels 1 & 11
 Continuous TX at Chain A Antenna port with Sony IRX-3980 Antennas
 Aegis Labs, Inc. File #: INTEL-070320-04*

RADIATED EMISSIONS - Horizontal Antenna Polarization												
Freq. (MHz)	Meter Reading (dBuV)	Antenna Height (cm)	Azimuth (degrees)	Quasi pk or AVG (dBuV)		Distance Factor (dB)	Cable Factor (dB)	Ant. Factor (dB)	Corrected Reading (dBuV)	Limits (dBuV)	Diff (dB) +=FAIL	Comments
2390.00	44.67	100	135			9.54	1.98	29.43	66.54	74.00	-7.46	Ch. 1
2390.00				26.00	A	9.54	1.98	29.43	47.87	54.00	-6.13	
2400.00	53.33	100	135			9.54	1.98	29.46	75.23	77.45	-2.22	
2483.50	46.67	100	225			9.54	2.02	29.74	68.90	74.00	-5.10	Ch. 11
2483.50				22.00	A	9.54	2.02	29.74	44.23	54.00	-9.77	

RADIATED EMISSIONS - Vertical Antenna Polarization												
Freq. (MHz)	Meter Reading (dBuV)	Antenna Height (cm)	Azimuth (degrees)	Quasi pk or AVG (dBuV)		Distance Factor (dB)	Cable Factor (dB)	Ant. Factor (dB)	Corrected Reading (dBuV)	Limits (dBuV)	Diff (dB) +=FAIL	Comments
2390.00	49.67	100	225			9.54	1.98	28.97	71.08	74.00	-2.92	Ch. 1
2390.00				26.33	A	9.54	1.98	28.97	47.74	54.00	-6.26	
2400.00	58.83	100	225			9.54	1.98	29.00	80.27	81.49	-1.21	
2483.50	39.33	100	225			9.54	2.02	29.25	61.06	74.00	-12.94	Ch. 11
2483.50				20.83	A	9.54	2.02	29.25	42.56	54.00	-11.44	

NOTE: The “Band Edge Field Strength” was calculated using the “Radiated Fundamental” measurements.

Radiated Emissions Test Results (Continued)

Plots Showing Out-Of-Band Emissions (Peak RBW=VBW=1MHz; Average RBW = 1MHz, VBW = 10Hz)

<i>Test Date</i>	<i>Data</i>	<i>Test Eng.</i>
03/21/07	2.412 GHz band edge PEAK DELTA (Vertical) (INTEL-070320-04a15)	BM
<p>*ATTEN 0dB MKR 49.67dBμV RL 97.0dBμV 10dB/ 2.39000GHz</p> <p>CENTER 2.41200GHz SPAN 50.00MHz *RBW 1.0MHz *VBW 1.0MHz SWP 50.0ms</p>		
<i>Test Date</i>	<i>Data</i>	<i>Test Eng.</i>
03/21/07	2.412 GHz band edge AVERAGE DELTA (Vertical) (INTEL-070320-04a16)	BM
<p>*ATTEN 0dB MKR 26.33dBμV RL 97.0dBμV 10dB/ 2.39000GHz</p> <p>CENTER 2.41200GHz SPAN 50.00MHz *RBW 1.0MHz *VBW 10Hz SWP 19.0sec</p>		

Radiated Emissions Test Results (Continued)

Plots Showing Out-Of-Band Emissions (Peak RBW=VBW=1MHz; Average RBW = 1MHz, VBW = 10Hz)

Test Date	Data	Test Eng.
03/21/07	2.462 GHz band edge PEAK DELTA (Horizontal) (INTEL-070320-04a17)	BM
<p>*ATTEN 0dB MKR 46.67dBμV RL 97.0dBμV 10dB/ 2.48350GHz</p> <p>CENTER 2.46200GHz SPAN 50.00MHz *RBW 1.0MHz *UBW 1.0MHz SWP 50.0ms</p>		
Test Date	Data	Test Eng.
03/21/07	2.462 GHz band edge AVERAGE DELTA (Horizontal) (INTEL-070320-04a18)	BM
<p>*ATTEN 0dB MKR 22.00dBμV RL 97.0dBμV 10dB/ 2.48350GHz</p> <p>CENTER 2.46200GHz SPAN 50.00MHz *RBW 1.0MHz *UBW 10Hz SWP 19.0sec</p>		

Radiated Emissions Test Results (Continued)

Plots Showing Out-Of-Band Emissions (Peak RBW=VBW=1MHz; Average RBW = 1MHz, VBW = 10Hz)

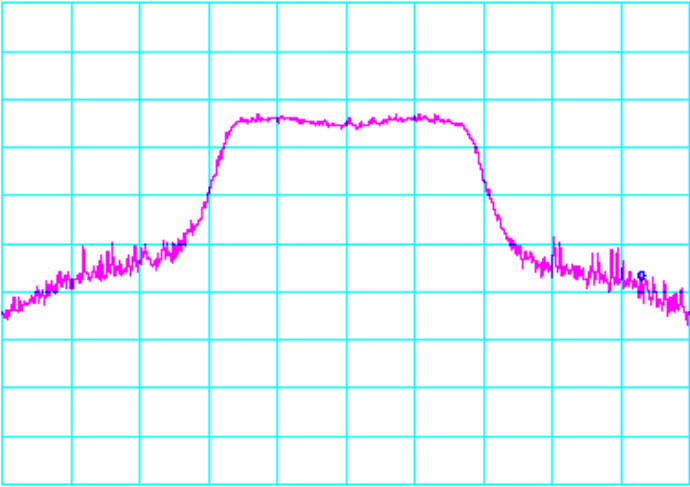
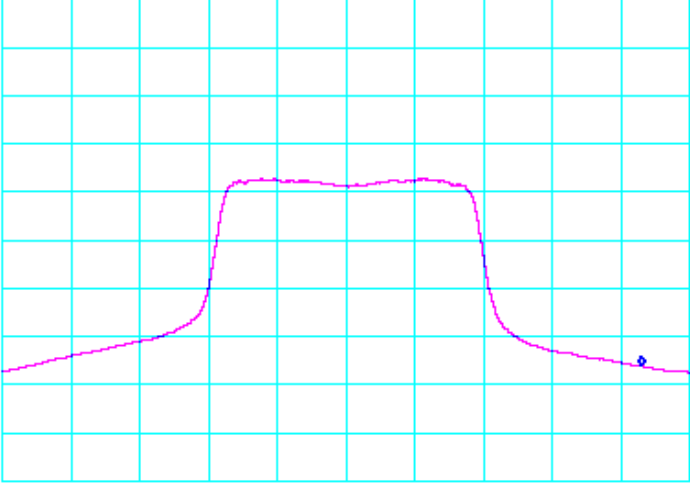
Test Date	Data	Test Eng.
03/21/07	2.462 GHz band edge PEAK DELTA (Vertical) (INTEL-070320-04a19)	BM
<div style="display: flex; justify-content: space-between; margin-bottom: 5px;"> *ATTEN 0dB MKR 39.33dBμV </div> <div style="display: flex; justify-content: space-between; margin-bottom: 5px;"> RL 97.0dBμV 10dB/ 2.48350GHz </div> <div style="text-align: center;">  </div> <div style="display: flex; justify-content: space-between; margin-top: 5px;"> CENTER 2.46200GHz SPAN 50.00MHz </div> <div style="display: flex; justify-content: space-between; margin-top: 5px;"> *RBW 1.0MHz *VBW 1.0MHz SWP 50.0ms </div>		
Test Date	Data	Test Eng.
03/21/07	2.462 GHz band edge AVERAGE DELTA (Vertical) (INTEL-070320-04a20)	BM
<div style="display: flex; justify-content: space-between; margin-bottom: 5px;"> *ATTEN 0dB MKR 20.83dBμV </div> <div style="display: flex; justify-content: space-between; margin-bottom: 5px;"> RL 97.0dBμV 10dB/ 2.48350GHz </div> <div style="text-align: center;">  </div> <div style="display: flex; justify-content: space-between; margin-top: 5px;"> CENTER 2.46200GHz SPAN 50.00MHz </div> <div style="display: flex; justify-content: space-between; margin-top: 5px;"> *RBW 1.0MHz *VBW 10Hz SWP 19.0sec </div>		



Radiated Emissions Test Results (Continued)

*Spurious Emissions Measurements in 802.11n mode 20MHz Wide (2400-2483.5 MHz)
Channels 1, 6, & 11
Continuous TX at Chain A Antenna port with Sony IRX-3980 Antennas
Aegis Labs, Inc. File #: INTEL-070320-12*

RADIATED EMISSIONS - Horizontal Antenna Polarization												
Freq. (MHz)	Meter Reading (dBuV)	Antenna Height (cm)	Azimuth (degrees)	Quasi pk or AVG (dBuV)		Distance Factor (dB)	Cable Factor (dB)	Ant. Factor (dB)	Corrected Reading (dBuV)	Limits (dBuV)	Diff (dB) +=FAIL	Comments
2720.00	32.67	100	225			9.54	2.12	30.42	55.67	74.00	-18.33	Ch. 1
2720.00				22.24	A	9.54	2.12	30.42	45.24	54.00	-8.76	
2720.00	33.33	100	225			9.54	2.12	30.42	56.33	74.00	-17.67	Ch. 6
2720.00				22.06	A	9.54	2.12	30.42	45.06	54.00	-8.94	
2720.00	33.67	100	225			9.54	2.12	30.42	56.67	74.00	-17.33	Ch. 11
2720.00				22.61	A	9.54	2.12	30.42	45.61	54.00	-8.39	

RADIATED EMISSIONS - Vertical Antenna Polarization												
Freq. (MHz)	Meter Reading (dBuV)	Antenna Height (cm)	Azimuth (degrees)	Quasi pk or AVG (dBuV)		Distance Factor (dB)	Cable Factor (dB)	Ant. Factor (dB)	Corrected Reading (dBuV)	Limits (dBuV)	Diff (dB) +=FAIL	Comments
2720.00	34.33	100	225			9.54	2.12	29.96	56.87	74.00	-17.13	Ch. 1
2720.00				24.62	A	9.54	2.12	29.96	47.16	54.00	-6.84	
2720.00	34.50	100	225			9.54	2.12	29.96	57.04	74.00	-16.96	Ch. 6
2720.00				23.86	A	9.54	2.12	29.96	46.40	54.00	-7.60	
2720.00	33.67	100	225			9.54	2.12	29.96	56.21	74.00	-17.79	Ch. 11
2720.00				24.48	A	9.54	2.12	29.96	47.02	54.00	-6.98	



Radiated Emissions Test Results (Continued)

*Spurious Emissions Measurements in 802.11n mode 20MHz Wide (2400-2483.5 MHz)
 Channels 1, 6, & 11
 Continuous TX at Chain A Antenna port with Sony IRX-3980 Antennas
 Aegis Labs, Inc. File #: INTEL-070320-09*

RADIATED EMISSIONS - Horizontal Antenna Polarization

Freq. (MHz)	Meter Reading (dBuV)	Antenna Height (cm)	Azimuth (degrees)	Quasi pk or AVG (dBuV)		Preamp Factor (dB)	Cable Factor (dB)	Ant. Factor (dB)	Corrected Reading (dBuV)	Limits (dBuV)	Diff (dB) +=FAIL	Comments
4824.00	57.00	100	225			51.08	2.87	33.91	42.71	74.00	-31.29	Ch. 1
4824.00				44.42	A	51.08	2.87	33.91	30.13	54.00	-23.87	
4873.83	57.50	100	225			51.12	2.89	34.02	43.29	74.00	-30.71	Ch. 6
4873.83				43.37	A	51.12	2.89	34.02	29.16	54.00	-24.84	
4924.02	56.83	100	225			51.15	2.90	34.13	42.71	74.00	-31.29	Ch. 11
4924.02				43.10	A	51.15	2.90	34.13	28.98	54.00	-25.02	

RADIATED EMISSIONS - Vertical Antenna Polarization

Freq. (MHz)	Meter Reading (dBuV)	Antenna Height (cm)	Azimuth (degrees)	Quasi pk or AVG (dBuV)		Preamp Factor (dB)	Cable Factor (dB)	Ant. Factor (dB)	Corrected Reading (dBuV)	Limits (dBuV)	Diff (dB) +=FAIL	Comments
4824.00	55.83	100	225			51.08	2.87	33.78	41.41	74.00	-32.59	Ch. 1
4824.00				43.08	A	51.08	2.87	33.78	28.66	54.00	-25.34	
4873.98	56.50	100	225			51.12	2.89	33.87	42.14	74.00	-31.86	Ch. 6
4873.98				42.71	A	51.12	2.89	33.87	28.35	54.00	-25.65	
4923.98	54.83	100	270			51.15	2.90	33.96	40.54	74.00	-33.46	Ch. 11
4923.98				42.44	A	51.15	2.90	33.96	28.15	54.00	-25.85	



Radiated Emissions Test Results (Continued)

*Fundamental Measurements in 802.11n mode 20MHz Wide (2400-2483.5 MHz)
Channels 1, 6, & 11
Continuous TX at Chain B Antenna port with Sony IRX-3980 Antennas
Aegis Labs, Inc. File #: INTEL-070320-05*

RADIATED EMISSIONS - Horizontal Antenna Polarization												
Freq. (MHz)	Meter Reading (dBuV)	Antenna Height (cm)	Azimuth (degrees)	Quasi pk or AVG (dBuV)		Distance Factor (dB)	Cable Factor (dB)	Ant. Factor (dB)	Corrected Reading (dBuV)	Limits (dBuV)	Diff (dB) +=FAIL	Comments
2412.00	76.17	100	180			9.54	1.99	29.50	98.12			Ch. 1
2412.00				61.00	A	9.54	1.99	29.50	82.95			
2437.00	75.33	100	180			9.54	2.00	29.59	97.38			Ch. 6
2437.00				58.67	A	9.54	2.00	29.59	80.72			
2462.00	72.17	100	225			9.54	2.01	29.67	94.31			Ch. 11
2462.00				57.67	A	9.54	2.01	29.67	79.81			

RADIATED EMISSIONS - Vertical Antenna Polarization												
Freq. (MHz)	Meter Reading (dBuV)	Antenna Height (cm)	Azimuth (degrees)	Quasi pk or AVG (dBuV)		Distance Factor (dB)	Cable Factor (dB)	Ant. Factor (dB)	Corrected Reading (dBuV)	Limits (dBuV)	Diff (dB) +=FAIL	Comments
2412.00	74.33	100	225			9.54	1.99	29.04	95.82			Ch. 1
2412.00				59.33	A	9.54	1.99	29.04	80.82			
2437.00	77.00	100	225			9.54	2.00	29.11	98.57			Ch. 6
2437.00				59.67	A	9.54	2.00	29.11	81.24			
2462.00	76.83	100	135			9.54	2.01	29.19	98.49			Ch. 11
2462.00				62.00	A	9.54	2.01	29.19	83.66			

NOTE: Fundamental signals measured at 1 meter and extrapolated to 3 meters to calculate the radiated band edge field strengths.



Radiated Emissions Test Results (Continued)

*Band Edge Field Strength Measurements in 802.11n mode 20MHz Wide (2400-2483.5 MHz)
Channels 1 & 11
Continuous TX at Chain B Antenna port with Sony IRX-3980 Antennas
Aegis Labs, Inc. File #: INTEL-070320-05*

RADIATED EMISSIONS - Horizontal Antenna Polarization

Freq. (MHz)	Meter Reading (dBuV)	Antenna Height (cm)	Azimuth (degrees)	Quasi pk or AVG (dBuV)	Distance Factor (dB)	Cable Factor (dB)	Ant. Factor (dB)	Corrected Reading (dBuV)	Limits (dBuV)	Diff (dB) +=FAIL	Comments	
2390.00	47.67	100	180		9.54	1.98	29.43	69.54	74.00	-4.46	Ch. 1	
2390.00				28.00	A	9.54	1.98	29.43	49.87	54.00	-4.13	
2400.00	54.83	100	180		9.54	1.98	29.46	76.73	78.12	-1.39		
2483.50	39.83	100	225		9.54	2.02	29.74	62.06	74.00	-11.94	Ch. 11	
2483.50				21.17	A	9.54	2.02	29.74	43.40	54.00	-10.60	

RADIATED EMISSIONS - Vertical Antenna Polarization

Freq. (MHz)	Meter Reading (dBuV)	Antenna Height (cm)	Azimuth (degrees)	Quasi pk or AVG (dBuV)	Distance Factor (dB)	Cable Factor (dB)	Ant. Factor (dB)	Corrected Reading (dBuV)	Limits (dBuV)	Diff (dB) +=FAIL	Comments	
2390.00	47.00	100	225		9.54	1.98	28.97	68.41	74.00	-5.59	Ch. 1	
2390.00				26.67	A	9.54	1.98	28.97	48.08	54.00	-5.92	
2400.00	53.17	100	225		9.54	1.98	29.00	74.61	75.82	-1.20		
2483.50	46.14	100	135		9.54	2.02	29.25	67.87	74.00	-6.13	Ch. 11	
2483.50				24.33	A	9.54	2.02	29.25	46.06	54.00	-7.94	

NOTE: The “Band Edge Field Strength” was calculated using the “Radiated Fundamental” measurements.





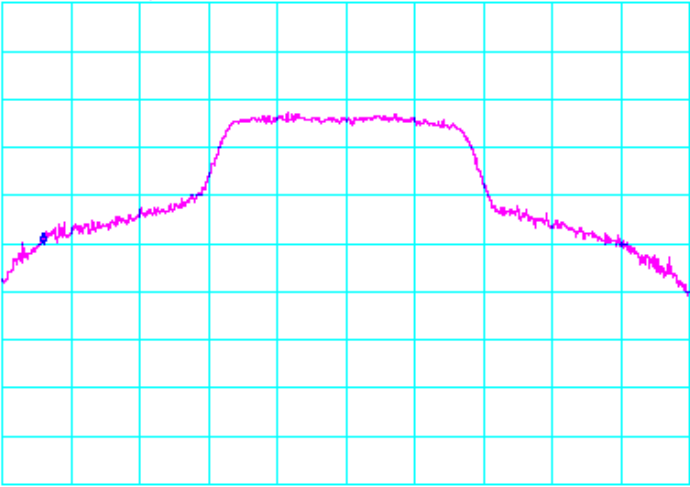
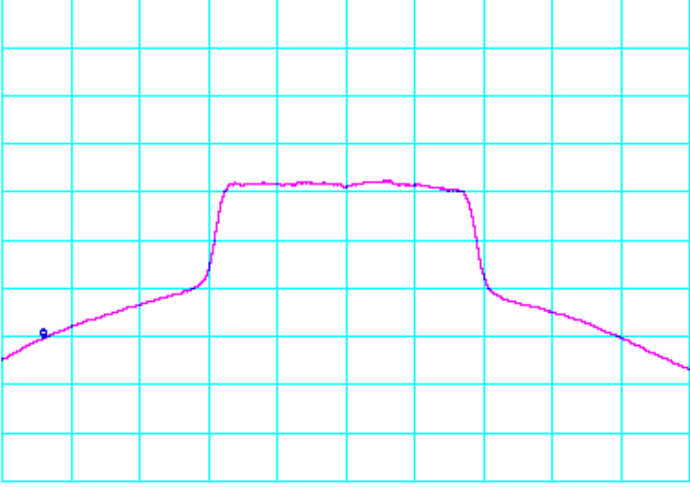

Radiated Emissions Test Results (Continued)

Plots Showing Out-Of-Band Emissions (Peak RBW=VBW=1MHz; Average RBW = 1MHz, VBW = 10Hz)

<i>Test Date</i>	<i>Data</i>	<i>Test Eng.</i>
03/22/07	2.412 GHz band edge PEAK DELTA (Vertical) (INTEL-070320-05a15)	BM
<div style="display: flex; justify-content: space-between;"> *ATTEN 0dB MKR 47.00dBμV </div> <div style="display: flex; justify-content: space-between;"> RL 97.0dBμV 10dB/ 2.39000GHz </div>  <div style="display: flex; justify-content: space-between; margin-top: 10px;"> CENTER 2.41200GHz SPAN 50.00MHz </div> <div style="display: flex; justify-content: space-between;"> *RBW 1.0MHz *VBW 1.0MHz SWP 50.0ms </div>		
<i>Test Date</i>	<i>Data</i>	<i>Test Eng.</i>
03/22/07	2.412 GHz band edge AVERAGE DELTA (Vertical) (INTEL-070320-05a16)	BM
<div style="display: flex; justify-content: space-between;"> *ATTEN 0dB MKR 26.67dBμV </div> <div style="display: flex; justify-content: space-between;"> RL 97.0dBμV 10dB/ 2.39000GHz </div>  <div style="display: flex; justify-content: space-between; margin-top: 10px;"> CENTER 2.41200GHz SPAN 50.00MHz </div> <div style="display: flex; justify-content: space-between;"> *RBW 1.0MHz *VBW 10Hz SWP 19.0sec </div>		

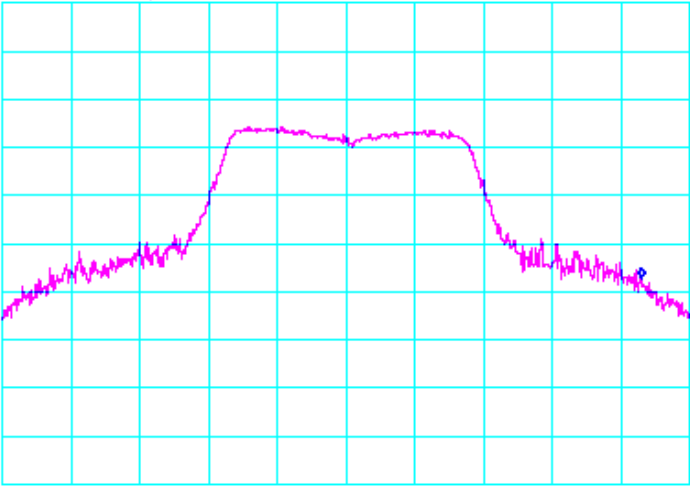
Radiated Emissions Test Results (Continued)

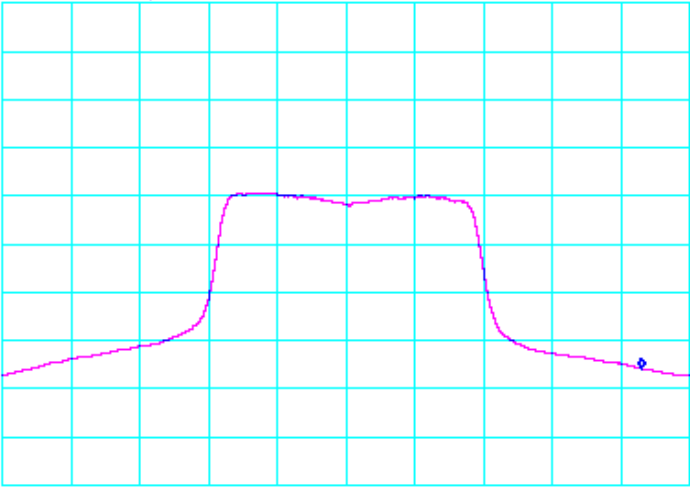
Plots Showing Out-Of-Band Emissions (Peak RBW=VBW=1MHz; Average RBW = 1MHz, VBW = 10Hz)

<i>Test Date</i>	<i>Data</i>	<i>Test Eng.</i>
03/22/07	2.462 GHz band edge PEAK DELTA (Horizontal) (INTEL-070320-05a17)	BM
<p>*ATTEN 0dB MKR 39.83dBµV RL 97.0dBµV 10dB/ 2.48350GHz</p>  <p>CENTER 2.46200GHz SPAN 50.00MHz *RBW 1.0MHz *VBW 1.0MHz SWP 50.0ms</p> 		
<i>Test Date</i>	<i>Data</i>	<i>Test Eng.</i>
03/22/07	2.462 GHz band edge AVERAGE DELTA (Horizontal) (INTEL-070320-05a18)	BM
<p>*ATTEN 0dB MKR 21.17dBµV RL 97.0dBµV 10dB/ 2.48350GHz</p>  <p>CENTER 2.46200GHz SPAN 50.00MHz *RBW 1.0MHz *VBW 10Hz SWP 19.0sec</p> 		



Radiated Emissions Test Results (Continued)

*Spurious Emissions Measurements in 802.11n mode 20MHz Wide (2400-2483.5 MHz)
Channels 1, 6, & 11
Continuous TX at Chain B Antenna port with Sony IRX-3980 Antennas
Aegis Labs, Inc. File #: INTEL-070320-12*

RADIATED EMISSIONS - Horizontal Antenna Polarization												
Freq. (MHz)	Meter Reading (dBuV)	Antenna Height (cm)	Azimuth (degrees)	Quasi pk or AVG (dBuV)		Distance Factor (dB)	Cable Factor (dB)	Ant. Factor (dB)	Corrected Reading (dBuV)	Limits (dBuV)	Diff (dB) +=FAIL	Comments
2720.00	32.50	100	225			9.54	2.12	30.42	55.50	74.00	-18.50	Ch. 1
2720.00				19.32	A	9.54	2.12	30.42	42.32	54.00	-11.68	
2720.00	32.17	100	180			9.54	2.12	30.42	55.17	74.00	-18.83	Ch. 6
2720.00				18.28	A	9.54	2.12	30.42	41.28	54.00	-12.72	
2720.00	32.67	100	225			9.54	2.12	30.42	55.67	74.00	-18.33	Ch. 11
2720.00				19.25	A	9.54	2.12	30.42	42.25	54.00	-11.75	

RADIATED EMISSIONS - Vertical Antenna Polarization												
Freq. (MHz)	Meter Reading (dBuV)	Antenna Height (cm)	Azimuth (degrees)	Quasi pk or AVG (dBuV)		Distance Factor (dB)	Cable Factor (dB)	Ant. Factor (dB)	Corrected Reading (dBuV)	Limits (dBuV)	Diff (dB) +=FAIL	Comments
2720.00	32.17	100	180			9.54	2.12	29.96	54.71	74.00	-19.29	Ch. 1
2720.00				19.80	A	9.54	2.12	29.96	42.34	54.00	-11.66	
2720.00	33.17	100	180			9.54	2.12	29.96	55.71	74.00	-18.29	Ch. 6
2720.00				18.75	A	9.54	2.12	29.96	41.29	54.00	-12.71	
2720.00	32.33	100	180			9.54	2.12	29.96	54.87	74.00	-19.13	Ch. 11
2720.00				19.32	A	9.54	2.12	29.96	41.86	54.00	-12.14	



Radiated Emissions Test Results (Continued)

*Spurious Emissions Measurements in 802.11g mode (2400-2483.5 MHz)
 Channels 1, 6, & 11
 Continuous TX at Chain B Antenna port with Sony IRX-3980 Antennas
 Aegis Labs, Inc. File #: INTEL-070320-10*

RADIATED EMISSIONS - Horizontal Antenna Polarization

Freq. (MHz)	Meter Reading (dBuV)	Antenna Height (cm)	Azimuth (degrees)	Quasi pk or AVG (dBuV)		Preamp Factor (dB)	Cable Factor (dB)	Ant. Factor (dB)	Corrected Reading (dBuV)	Limits (dBuV)	Diff (dB) +=FAIL	Comments
4824.00	59.83	100	135			51.08	2.87	33.91	45.54	74.00	-28.46	Ch. 1
4824.00				46.59	A	51.08	2.87	33.91	32.30	54.00	-21.70	
4873.98	61.67	100	135			51.12	2.89	34.02	47.46	74.00	-26.54	Ch. 6
4873.98				48.02	A	51.12	2.89	34.02	33.81	54.00	-20.19	
4923.98	60.33	100	135			51.15	2.90	34.13	46.21	74.00	-27.79	Ch. 11
4923.98				47.46	A	51.15	2.90	34.13	33.34	54.00	-20.66	

RADIATED EMISSIONS - Vertical Antenna Polarization

Freq. (MHz)	Meter Reading (dBuV)	Antenna Height (cm)	Azimuth (degrees)	Quasi pk or AVG (dBuV)		Preamp Factor (dB)	Cable Factor (dB)	Ant. Factor (dB)	Corrected Reading (dBuV)	Limits (dBuV)	Diff (dB) +=FAIL	Comments
4824.00	59.00	100	135			51.08	2.87	33.78	44.58	74.00	-29.42	Ch. 1
4824.00				45.68	A	51.08	2.87	33.78	31.26	54.00	-22.74	
4873.83	60.17	100	135			51.12	2.89	33.87	45.81	74.00	-28.19	Ch. 6
4873.83				46.37	A	51.12	2.89	33.87	32.01	54.00	-21.99	
4924.02	59.67	100	135			51.15	2.90	33.96	45.38	74.00	-28.62	Ch. 11
4924.02				45.96	A	51.15	2.90	33.96	31.67	54.00	-22.33	



Radiated Emissions Test Results (Continued)

*Fundamental Measurements in 802.11n mode 20MHz Wide (2400-2483.5 MHz)
Channels 1, 6, & 11
Continuous TX at Dual Chain AB Antenna port with Sony IRX-3980 Antennas
Aegis Labs, Inc. File #: INTEL-070320-06*

RADIATED EMISSIONS - Horizontal Antenna Polarization												
Freq. (MHz)	Meter Reading (dBuV)	Antenna Height (cm)	Azimuth (degrees)	Quasi pk or AVG (dBuV)		Distance Factor (dB)	Cable Factor (dB)	Ant. Factor (dB)	Corrected Reading (dBuV)	Limits (dBuV)	Diff (dB) +=FAIL	Comments
2412.00	75.17	100	225			9.54	1.99	29.50	97.12			Ch. 1
2412.00				55.83	A	9.54	1.99	29.50	77.78			
2437.00	57.67	100	135			9.54	2.00	29.59	79.72			Ch. 6
2437.00				44.00	A	9.54	2.00	29.59	66.05			
2462.00	77.00	100	225			9.54	2.01	29.67	99.14			Ch. 11
2462.00				56.67	A	9.54	2.01	29.67	78.81			

RADIATED EMISSIONS - Vertical Antenna Polarization												
Freq. (MHz)	Meter Reading (dBuV)	Antenna Height (cm)	Azimuth (degrees)	Quasi pk or AVG (dBuV)		Distance Factor (dB)	Cable Factor (dB)	Ant. Factor (dB)	Corrected Reading (dBuV)	Limits (dBuV)	Diff (dB) +=FAIL	Comments
2412.00	72.33	100	225			9.54	1.99	29.04	93.82			Ch. 1
2412.00				53.33	A	9.54	1.99	29.04	74.82			
2437.00	57.83	125	135			9.54	2.00	29.11	79.40			Ch. 6
2437.00				43.67	A	9.54	2.00	29.11	65.24			
2462.00	77.67	125	225			9.54	2.01	29.19	99.33			Ch. 11
2462.00				58.00	A	9.54	2.01	29.19	79.66			

NOTE: Fundamental signals measured at 1 meter and extrapolated to 3 meters to calculate the radiated band edge field strengths.



Radiated Emissions Test Results (Continued)

*Band Edge Field Strength Measurements in 802.11n mode 20MHz Wide (2400-2483.5 MHz)
Channels 1 & 11
Continuous TX at Dual Chain AB Antenna port with Sony IRX-3980 Antennas
Aegis Labs, Inc. File #: INTEL-070320-06*

RADIATED EMISSIONS - Horizontal Antenna Polarization

Freq. (MHz)	Meter Reading (dBuV)	Antenna Height (cm)	Azimuth (degrees)	Quasi pk or AVG (dBuV)		Distance Factor (dB)	Cable Factor (dB)	Ant. Factor (dB)	Corrected Reading (dBuV)	Limits (dBuV)	Diff (dB) +=FAIL	Comments
2390.00	41.50	100	225			9.54	1.98	29.43	63.37	74.00	-10.63	Ch. 1
2390.00				21.67	A	9.54	1.98	29.43	43.54	54.00	-10.46	
2400.00	52.17	100	225			9.54	1.98	29.46	74.07	77.12	-3.05	
2483.50	37.17	100	225			9.54	2.02	29.74	59.40	74.00	-14.60	Ch. 11
2483.50				20.33	A	9.54	2.02	29.74	42.56	54.00	-11.44	

RADIATED EMISSIONS - Vertical Antenna Polarization

Freq. (MHz)	Meter Reading (dBuV)	Antenna Height (cm)	Azimuth (degrees)	Quasi pk or AVG (dBuV)		Distance Factor (dB)	Cable Factor (dB)	Ant. Factor (dB)	Corrected Reading (dBuV)	Limits (dBuV)	Diff (dB) +=FAIL	Comments
2390.00	37.17	100	225			9.54	1.98	28.97	58.58	74.00	-15.42	Ch. 1
2390.00				21.17	A	9.54	1.98	28.97	42.58	54.00	-11.42	
2400.00	50.67	100	225			9.54	1.98	29.00	72.11	73.82	-1.70	
2483.50	37.83	125	225			9.54	2.02	29.25	59.56	74.00	-14.44	Ch. 11
2483.50				20.33	A	9.54	2.02	29.25	42.06	54.00	-11.94	

NOTE: The “Band Edge Field Strength” was calculated using the “Radiated Fundamental” measurements.



Radiated Emissions Test Results (Continued)

*Spurious Emissions Measurements in 802.11n mode 20MHz Wide (2400-2483.5 MHz)
Channels 1, 6, & 11
Continuous TX at Dual Chain AB Antenna port with Sony IRX-3980 Antennas
Aegis Labs, Inc. File #: INTEL-070320-12*

RADIATED EMISSIONS - Horizontal Antenna Polarization												
Freq. (MHz)	Meter Reading (dBuV)	Antenna Height (cm)	Azimuth (degrees)	Quasi pk or AVG (dBuV)		Distance Factor (dB)	Cable Factor (dB)	Ant. Factor (dB)	Corrected Reading (dBuV)	Limits (dBuV)	Diff (dB) +=FAIL	Comments
2720.00	32.33	100	225			9.54	2.12	30.42	55.33	74.00	-18.67	Ch. 1
2720.00				20.74	A	9.54	2.12	30.42	43.74	54.00	-10.26	
2720.00	33.00	100	225			9.54	2.12	30.42	56.00	74.00	-18.00	Ch. 6
2720.00				21.37	A	9.54	2.12	30.42	44.37	54.00	-9.63	
2720.00	32.50	100	225			9.54	2.12	30.42	55.50	74.00	-18.50	Ch. 11
2720.00				20.80	A	9.54	2.12	30.42	43.80	54.00	-10.20	

RADIATED EMISSIONS - Vertical Antenna Polarization												
Freq. (MHz)	Meter Reading (dBuV)	Antenna Height (cm)	Azimuth (degrees)	Quasi pk or AVG (dBuV)		Distance Factor (dB)	Cable Factor (dB)	Ant. Factor (dB)	Corrected Reading (dBuV)	Limits (dBuV)	Diff (dB) +=FAIL	Comments
2720.00	32.83	100	225			9.54	2.12	29.96	55.37	74.00	-18.63	Ch. 1
2720.00				19.46	A	9.54	2.12	29.96	42.00	54.00	-12.00	
2720.00	32.33	100	225			9.54	2.12	29.96	54.87	74.00	-19.13	Ch. 6
2720.00				18.56	A	9.54	2.12	29.96	41.10	54.00	-12.90	
2720.00	32.17	100	225			9.54	2.12	29.96	54.71	74.00	-19.29	Ch. 11
2720.00				18.86	A	9.54	2.12	29.96	41.40	54.00	-12.60	



Radiated Emissions Test Results (Continued)

*Spurious Emissions Measurements in 802.11n mode 20MHz Wide (2400-2483.5 MHz)
 Channels 1, 6, & 11
 Continuous TX at Dual Chain AB Antenna port with Sony IRX-3980 Antennas
 Aegis Labs, Inc. File #: INTEL-070320-11*

RADIATED EMISSIONS - Horizontal Antenna Polarization

Freq. (MHz)	Meter Reading (dBuV)	Antenna Height (cm)	Azimuth (degrees)	Quasi pk or AVG (dBuV)	Preamp Factor (dB)	Cable Factor (dB)	Ant. Factor (dB)	Corrected Reading (dBuV)	Limits (dBuV)	Diff (dB) +=FAIL	Comments	
9648.00	52.00	100	225			50.15	4.15	38.12	44.11	58.45	-14.34	Ch. 1
9747.88	51.83	100	225			50.19	4.18	38.20	44.02	59.72	-15.70	Ch. 6
9848.01	50.83	100	225			50.23	4.21	38.28	43.09	61.14	-18.05	Ch. 11

RADIATED EMISSIONS - Vertical Antenna Polarization

Freq. (MHz)	Meter Reading (dBuV)	Antenna Height (cm)	Azimuth (degrees)	Quasi pk or AVG (dBuV)	Preamp Factor (dB)	Cable Factor (dB)	Ant. Factor (dB)	Corrected Reading (dBuV)	Limits (dBuV)	Diff (dB) +=FAIL	Comments	
9647.62	51.67	100	180			50.15	4.15	38.09	43.75	58.49	-14.74	Ch. 1
9747.62	52.17	100	180			50.19	4.18	38.15	44.31	59.40	-15.09	Ch. 6
9848.28	51.00	100	180			50.23	4.21	38.21	43.19	59.99	-16.80	Ch. 11



RADIATED EMISSIONS TEST RESULTS

CLIENT:	Intel Corporation	DATE:	03/21/07
EUT:	Intel Wireless WiFi Link 4965AGN	PROJECT NUMBER:	INTEL-070320
MODEL NUMBER:	4965AGN	TEST ENGINEER:	BM/JC
SERIAL NUMBER:	0013E804612B	SITE #:	1
CONFIGURATION:	Tested installed in the host computer's mini PCI slot in 802.11n (5745-5825 MHz) mode 20MHz Wide with Sony IRX-3980 Antennas.	TEMPERATURE:	10 deg. C
		HUMIDITY:	62% RH
		TIME:	7:00 PM

Description:	Radiated RF Emissions (1 GHz – 18 GHz)
Results:	PASSED Horizontal and Vertical Antenna Polarizations Class B Limits
Note:	Radiated Emissions Measurements were performed on the EUT with power supply set at the following voltage and frequency. <ul style="list-style-type: none"> • 120VAC / 60 Hz.

Unwanted Spurious Emissions Limits			
Frequency (MHz)	Field Strength (uV/m)	Field Strength (dBuV/m) (Emissions in the restricted bands)	Field Strength (dBm/MHz) (Emissions outside the restricted bands)
Above 960	500	54.00 (Average) 74.00 (Peak)	< -20 dBc

Radiated Emissions Sample Calculations

$$\text{Corrected Meter Reading} = \text{Meter Reading} + F + C - D$$

Where, F = Antenna Factor

C = Cable Factor

G = Amplifier Gain

D = Distance Factor (if applicable)

Therefore, the equation for determining the Corrected Meter Reading Limit (CML) is:

$$\text{CML} = \text{Specification Limit} - F - C + D$$



Radiated Emissions Test Results (Continued)

*Fundamental Measurements in 802.11n mode 20MHz Wide (5745-5825 MHz)
Channels 149, 157, & 165
Continuous TX at Chain A Antenna port with Sony IRX-3980 Antennas
Aegis Labs, Inc. File #: INTEL-070320-04*

RADIATED EMISSIONS - Horizontal Antenna Polarization												
Freq. (MHz)	Meter Reading (dBuV)	Antenna Height (cm)	Azimuth (degrees)	Quasi pk or AVG (dBuV)		Distance Factor (dB)	Cable Factor (dB)	Ant. Factor (dB)	Corrected Reading (dBuV)	Limits (dBuV)	Diff (dB) +=FAIL	Comments
5745.00	67.00	100	225			9.54	3.15	35.25	95.86			Ch. 149
5745.00				52.17	A	9.54	3.15	35.25	81.03			
5785.00	74.50	100	225			9.54	3.17	35.26	103.38			Ch. 157
5785.00				59.67	A	9.54	3.17	35.26	88.55			
5825.00	61.50	100	225			9.54	3.18	35.27	90.40			Ch. 165
5825.00				47.83	A	9.54	3.18	35.27	76.73			

RADIATED EMISSIONS - Vertical Antenna Polarization												
Freq. (MHz)	Meter Reading (dBuV)	Antenna Height (cm)	Azimuth (degrees)	Quasi pk or AVG (dBuV)		Distance Factor (dB)	Cable Factor (dB)	Ant. Factor (dB)	Corrected Reading (dBuV)	Limits (dBuV)	Diff (dB) +=FAIL	Comments
5745.00	64.00	100	225			9.54	3.15	35.05	92.66			Ch. 149
5745.00				49.17	A	9.54	3.15	35.05	77.83			
5785.00	73.17	125	180			9.54	3.17	35.07	101.87			Ch. 157
5785.00				59.33	A	9.54	3.17	35.07	88.03			
5825.00	62.50	100	225			9.54	3.18	35.10	91.23			Ch. 165
5825.00				48.33	A	9.54	3.18	35.10	77.06			

NOTE: Fundamental signals measured at 1 meter and extrapolated to 3 meters to calculate the radiated band edge field strengths.



Radiated Emissions Test Results (Continued)

*Band Edge Field Strength Measurements in 802.11n mode 20MHz Wide (5745-5825 MHz)
Channels 149 & 165
Continuous TX at Chain A Antenna port with Sony IRX-3980 Antennas
Aegis Labs, Inc. File #: INTEL-070320-04*

RADIATED EMISSIONS - Horizontal Antenna Polarization

Freq. (MHz)	Meter Reading (dBuV)	Antenna Height (cm)	Azimuth (degrees)	Quasi pk or AVG (dBuV)	Distance Factor (dB)	Cable Factor (dB)	Ant. Factor (dB)	Corrected Reading (dBuV)	Limits (dBuV)	Diff (dB) +=FAIL	Comments
5725.00	36.33	100	225		9.54	3.15	35.25	65.18	75.86	-10.68	Ch. 149
5850.00	29.00	100	225		9.54	3.19	35.27	57.92	70.40	-12.49	Ch. 165

RADIATED EMISSIONS - Vertical Antenna Polarization

Freq. (MHz)	Meter Reading (dBuV)	Antenna Height (cm)	Azimuth (degrees)	Quasi pk or AVG (dBuV)	Distance Factor (dB)	Cable Factor (dB)	Ant. Factor (dB)	Corrected Reading (dBuV)	Limits (dBuV)	Diff (dB) +=FAIL	Comments
5725.00	35.50	100	225		9.54	3.15	35.04	64.14	72.66	-8.52	Ch. 149
5850.00	29.83	100	225		9.54	3.19	35.11	58.59	71.23	-12.65	Ch. 165

NOTE: The “Band Edge Field Strength” was calculated using the “Radiated Fundamental” measurements.



Radiated Emissions Test Results (Continued)

*Spurious Emissions Measurements in 802.11n mode 20MHz Wide (5745-5825 MHz)
 Channels 149, 157, & 165
 Continuous TX at Chain A Antenna port with Sony IRX-3980 Antennas
 Aegis Labs, Inc. File #: INTEL-070320-09*

RADIATED EMISSIONS - Horizontal Antenna Polarization

Freq. (MHz)	Meter Reading (dBuV)	Antenna Height (cm)	Azimuth (degrees)	Quasi pk or AVG (dBuV)		Preamp Factor (dB)	Cable Factor (dB)	Ant. Factor (dB)	Corrected Reading (dBuV)	Limits (dBuV)	Diff (dB) +=FAIL	Comments
3830.04	55.67	100	135			50.78	2.57	33.13	40.58	74.00	-33.42	Ch. 149
3830.04				46.20	A	50.78	2.57	33.13	31.11	54.00	-22.89	
3856.44	56.50	100	135			50.78	2.58	33.18	41.48	74.00	-32.52	Ch. 157
3856.44				47.10	A	50.78	2.58	33.18	32.08	54.00	-21.92	
3883.18	57.17	100	135			50.78	2.59	33.24	42.22	74.00	-31.78	Ch.165
3883.18				48.32	A	50.78	2.59	33.24	33.37	54.00	-20.63	

RADIATED EMISSIONS - Vertical Antenna Polarization

Freq. (MHz)	Meter Reading (dBuV)	Antenna Height (cm)	Azimuth (degrees)	Quasi pk or AVG (dBuV)		Preamp Factor (dB)	Cable Factor (dB)	Ant. Factor (dB)	Corrected Reading (dBuV)	Limits (dBuV)	Diff (dB) +=FAIL	Comments
3830.04	55.83	100	225			50.78	2.57	32.76	40.37	74.00	-33.63	Ch. 149
3830.04				46.04	A	50.78	2.57	32.76	30.58	54.00	-23.42	
3856.44	57.17	100	225			50.78	2.58	32.83	41.79	74.00	-32.21	Ch. 157
3856.44				47.71	A	50.78	2.58	32.83	32.33	54.00	-21.67	
3883.32	56.67	100	225			50.78	2.59	32.90	41.37	74.00	-32.63	Ch.165
3883.32				47.06	A	50.78	2.59	32.90	31.76	54.00	-22.24	



Radiated Emissions Test Results (Continued)

*Fundamental Measurements in 802.11n mode 20MHz Wide (5745-5825 MHz)
Channels 149, 157, & 165
Continuous TX at Chain B Antenna port with Sony IRX-3980 Antennas
Aegis Labs, Inc. File #: INTEL-070320-05*

RADIATED EMISSIONS - Horizontal Antenna Polarization												
Freq. (MHz)	Meter Reading (dBuV)	Antenna Height (cm)	Azimuth (degrees)	Quasi pk or AVG (dBuV)		Distance Factor (dB)	Cable Factor (dB)	Ant. Factor (dB)	Corrected Reading (dBuV)	Limits (dBuV)	Diff (dB) +=FAIL	Comments
5745.00	74.00	100	225			9.54	3.15	35.25	102.86			Ch. 149
5745.00				59.33	A	9.54	3.15	35.25	88.19			
5785.00	76.17	100	225			9.54	3.17	35.26	105.05			Ch. 157
5785.00				58.17	A	9.54	3.17	35.26	87.05			
5825.00	75.83	100	225			9.54	3.18	35.27	104.73			Ch. 165
5825.00				60.67	A	9.54	3.18	35.27	89.57			

RADIATED EMISSIONS - Vertical Antenna Polarization												
Freq. (MHz)	Meter Reading (dBuV)	Antenna Height (cm)	Azimuth (degrees)	Quasi pk or AVG (dBuV)		Distance Factor (dB)	Cable Factor (dB)	Ant. Factor (dB)	Corrected Reading (dBuV)	Limits (dBuV)	Diff (dB) +=FAIL	Comments
5745.00	74.83	100	225			9.54	3.15	35.05	103.49			Ch. 149
5745.00				59.67	A	9.54	3.15	35.05	88.33			
5785.00	74.00	100	225			9.54	3.17	35.07	102.70			Ch. 157
5785.00				60.83	A	9.54	3.17	35.07	89.53			
5825.00	72.50	100	225			9.54	3.18	35.10	101.23			Ch. 165
5825.00				58.50	A	9.54	3.18	35.10	87.23			

NOTE: Fundamental signals measured at 1 meter and extrapolated to 3 meters to calculate the radiated band edge field strengths.



Radiated Emissions Test Results (Continued)

*Band Edge Field Strength Measurements in 802.11n mode 20MHz Wide (5745-5825 MHz)
 Channels 149 & 165
 Continuous TX at Chain B Antenna port with Sony IRX-3980 Antennas
 Aegis Labs, Inc. File #: INTEL-070320-05*

RADIATED EMISSIONS - Horizontal Antenna Polarization												
<i>Freq. (MHz)</i>	<i>Meter Reading (dBuV)</i>	<i>Antenna Height (cm)</i>	<i>Azimuth (degrees)</i>	<i>Quasi pk or AVG (dBuV)</i>	<i>Distance Factor (dB)</i>	<i>Cable Factor (dB)</i>	<i>Ant. Factor (dB)</i>	<i>Corrected Reading (dBuV)</i>	<i>Limits (dBuV)</i>	<i>Diff (dB) +=FAIL</i>	<i>Comments</i>	
5725.00	43.83	100	225		9.54	3.15	35.25	72.68	82.86	-10.18	Ch. 149	
5850.00	40.50	100	225		9.54	3.19	35.27	69.42	84.73	-15.32	Ch. 165	

RADIATED EMISSIONS - Vertical Antenna Polarization												
<i>Freq. (MHz)</i>	<i>Meter Reading (dBuV)</i>	<i>Antenna Height (cm)</i>	<i>Azimuth (degrees)</i>	<i>Quasi pk or AVG (dBuV)</i>	<i>Distance Factor (dB)</i>	<i>Cable Factor (dB)</i>	<i>Ant. Factor (dB)</i>	<i>Corrected Reading (dBuV)</i>	<i>Limits (dBuV)</i>	<i>Diff (dB) +=FAIL</i>	<i>Comments</i>	
5725.00	41.50	100	225		9.54	3.15	35.04	70.14	83.49	-13.35	Ch. 149	
5850.00	38.50	100	225		9.54	3.19	35.11	67.26	81.23	-13.98	Ch. 165	

NOTE: The “Band Edge Field Strength” was calculated using the “Radiated Fundamental” measurements.



Radiated Emissions Test Results (Continued)

*Spurious Emissions Measurements in 802.11n mode 20MHz Wide (5745-5825 MHz)
Channels 149, 157, & 165
Continuous TX at Chain B Antenna port with Sony IRX-3980 Antennas
Aegis Labs, Inc. File #: INTEL-070320-10*

RADIATED EMISSIONS - Horizontal Antenna Polarization												
Freq. (MHz)	Meter Reading (dBuV)	Antenna Height (cm)	Azimuth (degrees)	Quasi pk or AVG (dBuV)		Preamp Factor (dB)	Cable Factor (dB)	Ant. Factor (dB)	Corrected Reading (dBuV)	Limits (dBuV)	Diff (dB) +=FAIL	Comments
3830.04	55.50	100	225			50.78	2.57	33.13	40.41	74.00	-33.59	Ch. 149
3830.04				46.28	A	50.78	2.57	33.13	31.19	54.00	-22.81	
11490.02	65.67	100	225			50.53	4.63	39.19	58.97	74.00	-15.03	
11490.02				51.76	A	50.53	4.63	39.19	45.06	54.00	-8.94	
3856.44	56.50	100	225			50.78	2.58	33.18	41.48	74.00	-32.52	Ch. 157
3856.44				47.59	A	50.78	2.58	33.18	32.57	54.00	-21.43	
11569.99	66.33	100	225			50.58	4.65	39.23	59.62	74.00	-14.38	
11569.99				52.48	A	50.58	4.65	39.23	45.77	54.00	-8.23	
3883.18	56.17	100	225			50.78	2.59	33.24	41.22	74.00	-32.78	Ch.165
3883.18				47.02	A	50.78	2.59	33.24	32.07	54.00	-21.93	
11650.01	61.33	100	225			50.64	4.66	39.26	54.61	74.00	-19.39	
11650.01				46.76	A	50.64	4.66	39.26	40.04	54.00	-13.96	

RADIATED EMISSIONS - Vertical Antenna Polarization												
Freq. (MHz)	Meter Reading (dBuV)	Antenna Height (cm)	Azimuth (degrees)	Quasi pk or AVG (dBuV)		Preamp Factor (dB)	Cable Factor (dB)	Ant. Factor (dB)	Corrected Reading (dBuV)	Limits (dBuV)	Diff (dB) +=FAIL	Comments
3830.04	56.50	100	180			50.78	2.57	32.76	41.04	74.00	-32.96	Ch. 149
3830.04				48.69	A	50.78	2.57	32.76	33.23	54.00	-20.77	
11490.00	67.83	100	180			50.53	4.63	39.19	61.13	74.00	-12.87	
11490.00				54.08	A	50.53	4.63	39.19	47.38	54.00	-6.62	
3856.44	57.17	100	180			50.78	2.58	32.83	41.79	74.00	-32.21	Ch. 157
3856.44				49.32	A	50.78	2.58	32.83	33.94	54.00	-20.06	
11569.99	68.83	100	225			50.58	4.65	39.23	62.12	74.00	-11.88	
11569.99				55.11	A	50.58	4.65	39.23	48.40	54.00	-5.60	
3883.18	56.33	100	180			50.78	2.59	32.90	41.03	74.00	-32.97	Ch.165
3883.18				48.07	A	50.78	2.59	32.90	32.77	54.00	-21.23	
11650.01	66.67	100	180			50.64	4.66	39.26	59.95	74.00	-14.05	
11650.01				52.15	A	50.64	4.66	39.26	45.43	54.00	-8.57	



Radiated Emissions Test Results (Continued)

*Fundamental Measurements in 802.11n mode 20MHz Wide (5745-5825 MHz)
 Channels 149, 157, & 165
 Continuous TX at Dual Chain AB Antenna port with Sony IRX-3980 Antennas
 Aegis Labs, Inc. File #: INTEL-070320-06*

RADIATED EMISSIONS - Horizontal Antenna Polarization												
Freq. (MHz)	Meter Reading (dBuV)	Antenna Height (cm)	Azimuth (degrees)	Quasi pk or AVG (dBuV)		Distance Factor (dB)	Cable Factor (dB)	Ant. Factor (dB)	Corrected Reading (dBuV)	Limits (dBuV)	Diff (dB) +=FAIL	Comments
5745.00	75.83	100	225			9.54	3.15	35.25	104.69			Ch. 149
5745.00				55.50	A	9.54	3.15	35.25	84.36			
5785.00	74.50	100	225			9.54	3.17	35.26	103.38			Ch. 157
5785.00				59.67	A	9.54	3.17	35.26	88.55			
5825.00	75.67	100	225			9.54	3.18	35.27	104.57			Ch. 165
5825.00				55.50	A	9.54	3.18	35.27	84.40			

RADIATED EMISSIONS - Vertical Antenna Polarization												
Freq. (MHz)	Meter Reading (dBuV)	Antenna Height (cm)	Azimuth (degrees)	Quasi pk or AVG (dBuV)		Distance Factor (dB)	Cable Factor (dB)	Ant. Factor (dB)	Corrected Reading (dBuV)	Limits (dBuV)	Diff (dB) +=FAIL	Comments
5745.00	74.67	125	225			9.54	3.15	35.05	103.33			Ch. 149
5745.00				55.00	A	9.54	3.15	35.05	83.66			
5785.00	73.17	125	180			9.54	3.17	35.07	101.87			Ch. 157
5785.00				59.33	A	9.54	3.17	35.07	88.03			
5825.00	72.67	100	225			9.54	3.18	35.10	101.40			Ch. 165
5825.00				53.83	A	9.54	3.18	35.10	82.56			

NOTE: Fundamental signals measured at 1 meter and extrapolated to 3 meters to calculate the radiated band edge field strengths.



Radiated Emissions Test Results (Continued)

*Band Edge Field Strength Measurements in 802.11n mode 20MHz Wide (5745-5825 MHz)
 Channels 149 & 165
 Continuous TX at Dual Chain AB Antenna port with Sony IRX-3980 Antennas
 Aegis Labs, Inc. File #: INTEL-070320-06*

RADIATED EMISSIONS - Horizontal Antenna Polarization												
<i>Freq. (MHz)</i>	<i>Meter Reading (dBuV)</i>	<i>Antenna Height (cm)</i>	<i>Azimuth (degrees)</i>	<i>Quasi pk or AVG (dBuV)</i>	<i>Distance Factor (dB)</i>	<i>Cable Factor (dB)</i>	<i>Ant. Factor (dB)</i>	<i>Corrected Reading (dBuV)</i>	<i>Limits (dBuV)</i>	<i>Diff (dB) +=FAIL</i>	<i>Comments</i>	
5725.00	34.50	100	225		9.54	3.15	35.25	63.35	84.69	-21.34	Ch. 149	
5850.00	30.67	100	225		9.54	3.19	35.27	59.59	84.57	-24.99	Ch. 165	

RADIATED EMISSIONS - Vertical Antenna Polarization												
<i>Freq. (MHz)</i>	<i>Meter Reading (dBuV)</i>	<i>Antenna Height (cm)</i>	<i>Azimuth (degrees)</i>	<i>Quasi pk or AVG (dBuV)</i>	<i>Distance Factor (dB)</i>	<i>Cable Factor (dB)</i>	<i>Ant. Factor (dB)</i>	<i>Corrected Reading (dBuV)</i>	<i>Limits (dBuV)</i>	<i>Diff (dB) +=FAIL</i>	<i>Comments</i>	
5725.00	35.33	125	225		9.54	3.15	35.04	63.97	83.33	-19.36	Ch. 149	
5850.00	30.00	100	225		9.54	3.19	35.11	58.76	81.40	-22.65	Ch. 165	

NOTE: The “Band Edge Field Strength” was calculated using the “Radiated Fundamental” measurements.



Radiated Emissions Test Results (Continued)

*Spurious Emissions Measurements in 802.11n mode 20MHz Wide (5745-5825 MHz)
 Channels 149, 157, & 165
 Continuous TX at Dual Chain AB Antenna port with Sony IRX-3980 Antennas
 Aegis Labs, Inc. File #: INTEL-070320-11*

RADIATED EMISSIONS - Horizontal Antenna Polarization

Freq. (MHz)	Meter Reading (dBuV)	Antenna Height (cm)	Azimuth (degrees)	Quasi pk or AVG (dBuV)		Preamp Factor (dB)	Cable Factor (dB)	Ant. Factor (dB)	Corrected Reading (dBuV)	Limits (dBuV)	Diff (dB) +=FAIL	Comments
3830.04	52.33	100	180			50.78	2.57	33.13	37.24	74.00	-36.76	Ch. 149
3830.04				40.98	A	50.78	2.57	33.13	25.89	54.00	-28.11	
3856.44	53.67	100	135			50.78	2.58	33.18	38.65	74.00	-35.35	Ch. 157
3856.44				42.01	A	50.78	2.58	33.18	26.99	54.00	-27.01	
3883.18	53.17	100	180			50.78	2.59	33.24	38.22	74.00	-35.78	Ch.165
3883.18				41.46	A	50.78	2.59	33.24	26.51	54.00	-27.49	

RADIATED EMISSIONS - Vertical Antenna Polarization

Freq. (MHz)	Meter Reading (dBuV)	Antenna Height (cm)	Azimuth (degrees)	Quasi pk or AVG (dBuV)		Preamp Factor (dB)	Cable Factor (dB)	Ant. Factor (dB)	Corrected Reading (dBuV)	Limits (dBuV)	Diff (dB) +=FAIL	Comments
3830.04	53.33	100	180			50.78	2.57	32.76	37.87	74.00	-36.13	Ch. 149
3830.04				42.49	A	50.78	2.57	32.76	27.03	54.00	-26.97	
3856.44	55.67	100	180			50.78	2.58	32.83	40.29	74.00	-33.71	Ch. 157
3856.44				43.12	A	50.78	2.58	32.83	27.74	54.00	-26.26	
3883.32	54.33	100	180			50.78	2.59	32.90	39.03	74.00	-34.97	Ch.165
3883.32				42.99	A	50.78	2.59	32.90	27.69	54.00	-26.31	



RADIATED EMISSIONS TEST RESULTS

CLIENT:	Intel Corporation	DATE:	03/21/07
EUT:	Intel Wireless WiFi Link 4965AGN	PROJECT NUMBER:	INTEL-070320
MODEL NUMBER:	4965AGN	TEST ENGINEER:	BM/JC
SERIAL NUMBER:	0013E804612B	SITE #:	1
CONFIGURATION:	Tested installed in the host computer's mini PCI slot in 802.11n (5745-5825 MHz) mode 40MHz Wide with Sony IRX-3980 Antennas.	TEMPERATURE:	10 deg. C
		HUMIDITY:	62% RH
		TIME:	7:00 PM

Description:	Radiated RF Emissions (1 GHz – 18 GHz)
Results:	PASSED Horizontal and Vertical Antenna Polarizations Class B Limits
Note:	Radiated Emissions Measurements were performed on the EUT with power supply set at the following voltage and frequency. <ul style="list-style-type: none"> 120VAC / 60 Hz.

Unwanted Spurious Emissions Limits			
Frequency (MHz)	Field Strength (uV/m)	Field Strength (dBuV/m) (Emissions in the restricted bands)	Field Strength (dBm/MHz) (Emissions outside the restricted bands)
Above 960	500	54.00 (Average) 74.00 (Peak)	< -20 dBc

Radiated Emissions Sample Calculations

$$\text{Corrected Meter Reading} = \text{Meter Reading} + F + C - D$$

Where, F = Antenna Factor

C = Cable Factor

G = Amplifier Gain

D = Distance Factor (if applicable)

Therefore, the equation for determining the Corrected Meter Reading Limit (CML) is:

$$\text{CML} = \text{Specification Limit} - F - C + D$$



Radiated Emissions Test Results (Continued)

*Fundamental Measurements in 802.11n mode 40MHz Wide (5745-5825 MHz)
 Channels 151 & 159
 Continuous TX at Chain A Antenna port with Sony IRX-3980 Antennas
 Aegis Labs, Inc. File #: INTEL-070320-04*

RADIATED EMISSIONS - Horizontal Antenna Polarization												
Freq. (MHz)	Meter Reading (dBuV)	Antenna Height (cm)	Azimuth (degrees)	Quasi pk or AVG (dBuV)		Distance Factor (dB)	Cable Factor (dB)	Ant. Factor (dB)	Corrected Reading (dBuV)	Limits (dBuV)	Diff (dB) +=FAIL	Comments
5755.00	72.83	100	225			9.54	3.16	35.25	101.70			Ch. 151
5755.00				54.33	A	9.54	3.16	35.25	83.20			
5795.00	73.83	100	225			9.54	3.17	35.26	102.72			Ch. 159
5795.00				55.17	A	9.54	3.17	35.26	84.06			

RADIATED EMISSIONS - Vertical Antenna Polarization												
Freq. (MHz)	Meter Reading (dBuV)	Antenna Height (cm)	Azimuth (degrees)	Quasi pk or AVG (dBuV)		Distance Factor (dB)	Cable Factor (dB)	Ant. Factor (dB)	Corrected Reading (dBuV)	Limits (dBuV)	Diff (dB) +=FAIL	Comments
5755.00	70.50	100	225			9.54	3.16	35.05	99.17			Ch. 151
5755.00				52.67	A	9.54	3.16	35.05	81.34			
5795.00	73.33	100	225			9.54	3.17	35.08	102.04			Ch. 159
5795.00				54.50	A	9.54	3.17	35.08	83.21			

NOTE: Fundamental signals measured at 1 meter and extrapolated to 3 meters to calculate the radiated band edge field strengths.



Radiated Emissions Test Results (Continued)

*Band Edge Field Strength Measurements in 802.11n mode 40MHz Wide (5745-5825 MHz)
 Channels 151 & 159
 Continuous TX at Chain A Antenna port with Sony IRX-3980 Antennas
 Aegis Labs, Inc. File #: INTEL-070320-04*

RADIATED EMISSIONS - Horizontal Antenna Polarization												
<i>Freq. (MHz)</i>	<i>Meter Reading (dBuV)</i>	<i>Antenna Height (cm)</i>	<i>Azimuth (degrees)</i>	<i>Quasi pk or AVG (dBuV)</i>	<i>Distance Factor (dB)</i>	<i>Cable Factor (dB)</i>	<i>Ant. Factor (dB)</i>	<i>Corrected Reading (dBuV)</i>	<i>Limits (dBuV)</i>	<i>Diff (dB) +=FAIL</i>	<i>Comments</i>	
5725.00	44.00	100	225		9.54	3.15	35.25	72.85	81.70	-8.85	Ch. 151	
5850.00	30.50	100	225		9.54	3.19	35.27	59.42	82.72	-23.30	Ch. 159	

RADIATED EMISSIONS - Vertical Antenna Polarization												
<i>Freq. (MHz)</i>	<i>Meter Reading (dBuV)</i>	<i>Antenna Height (cm)</i>	<i>Azimuth (degrees)</i>	<i>Quasi pk or AVG (dBuV)</i>	<i>Distance Factor (dB)</i>	<i>Cable Factor (dB)</i>	<i>Ant. Factor (dB)</i>	<i>Corrected Reading (dBuV)</i>	<i>Limits (dBuV)</i>	<i>Diff (dB) +=FAIL</i>	<i>Comments</i>	
5725.00	39.33	100	225		9.54	3.15	35.04	67.97	79.17	-11.20	Ch. 151	
5850.00	29.83	100	225		9.54	3.19	35.11	58.59	82.04	-23.45	Ch. 159	

NOTE: The “Band Edge Field Strength” was calculated using the “Radiated Fundamental” measurements.



Radiated Emissions Test Results (Continued)

*Spurious Emissions Measurements in 802.11n mode 40MHz Wide (5745-5825 MHz)
Channels 151 & 159
Continuous TX at Chain A Antenna port with Sony IRX-3980 Antennas
Aegis Labs, Inc. File #: INTEL-070320-09*

RADIATED EMISSIONS - Horizontal Antenna Polarization

Freq. (MHz)	Meter Reading (dBuV)	Antenna Height (cm)	Azimuth (degrees)	Quasi pk or AVG (dBuV)		Preamp Factor (dB)	Cable Factor (dB)	Ant. Factor (dB)	Corrected Reading (dBuV)	Limits (dBuV)	Diff (dB) +=FAIL	Comments
3836.78	56.50	100	135			50.78	2.57	33.14	41.43	74.00	-32.57	Ch. 151
3836.78				47.80	A	50.78	2.57	33.14	32.73	54.00	-21.27	
11509.71	58.50	100	180			50.54	4.64	39.20	51.81	74.00	-22.19	
11509.71				44.95	A	50.54	4.64	39.20	38.26	54.00	-15.74	
3863.46	65.00	100	180			50.78	2.58	33.20	50.00	74.00	-24.00	Ch.159
3863.46				49.35	A	50.78	2.58	33.20	34.35	54.00	-19.65	
11589.56	61.00	100	225			50.60	4.65	39.24	54.29	74.00	-19.71	
11589.56				47.67	A	50.60	4.65	39.24	40.96	54.00	-13.04	

RADIATED EMISSIONS - Vertical Antenna Polarization

Freq. (MHz)	Meter Reading (dBuV)	Antenna Height (cm)	Azimuth (degrees)	Quasi pk or AVG (dBuV)		Preamp Factor (dB)	Cable Factor (dB)	Ant. Factor (dB)	Corrected Reading (dBuV)	Limits (dBuV)	Diff (dB) +=FAIL	Comments
3836.81	56.33	100	180			50.78	2.57	32.78	40.89	74.00	-33.11	Ch. 151
3836.81				48.00	A	50.78	2.57	32.78	32.56	54.00	-21.44	
11509.66	57.67	100	180			50.54	4.64	39.20	50.98	74.00	-23.02	
11509.66				44.34	A	50.54	4.64	39.20	37.65	54.00	-16.35	
3863.44	69.33	100	180			50.78	2.58	32.84	53.97	74.00	-20.03	Ch.159
3863.44				50.25	A	50.78	2.58	32.84	34.89	54.00	-19.11	
11590.07	57.17	100	180			50.60	4.65	39.24	50.46	74.00	-23.54	
11590.07				44.32	A	50.60	4.65	39.24	37.61	54.00	-16.39	



Radiated Emissions Test Results (Continued)

*Spurious Emissions Measurements in 802.11n mode 40MHz Wide (5745-5825 MHz)
 Channels 151 & 159
 Continuous RX at Chain A Antenna port with Sony IRX-3980 Antennas
 Aegis Labs, Inc. File #: INTEL-070320-09*

RADIATED EMISSIONS - Horizontal Antenna Polarization

Freq. (MHz)	Meter Reading (dBuV)	Antenna Height (cm)	Azimuth (degrees)	Quasi pk or AVG (dBuV)		Preamp Factor (dB)	Cable Factor (dB)	Ant. Factor (dB)	Corrected Reading (dBuV)	Limits (dBuV)	Diff (dB) +=FAIL	Comments
3836.66	58.50	125	225			50.78	2.57	33.14	43.43	74.00	-30.57	Ch. 151
3836.66				52.34	A	50.78	2.57	33.14	37.27	54.00	-16.73	
3863.33	70.17	100	270			50.78	2.58	33.20	55.17	74.00	-18.83	Ch.159
3863.33				52.46	A	50.78	2.58	33.20	37.46	54.00	-16.54	

RADIATED EMISSIONS - Vertical Antenna Polarization

Freq. (MHz)	Meter Reading (dBuV)	Antenna Height (cm)	Azimuth (degrees)	Quasi pk or AVG (dBuV)		Preamp Factor (dB)	Cable Factor (dB)	Ant. Factor (dB)	Corrected Reading (dBuV)	Limits (dBuV)	Diff (dB) +=FAIL	Comments
3836.66	56.83	100	180			50.78	2.57	33.14	41.76	74.00	-32.24	Ch. 151
3836.66				49.00	A	50.78	2.57	33.14	33.93	54.00	-20.07	
3863.33	66.00	100	45			50.78	2.58	32.84	50.64	74.00	-23.36	Ch.159
3863.33				50.98	A	50.78	2.58	32.84	35.62	54.00	-18.38	



Radiated Emissions Test Results (Continued)

*Fundamental Measurements in 802.11n mode 40MHz Wide (5745-5825 MHz)
 Channels 151 & 159
 Continuous TX at Chain B Antenna port with Sony IRX-3980 Antennas
 Aegis Labs, Inc. File #: INTEL-070320-05*

RADIATED EMISSIONS - Horizontal Antenna Polarization												
Freq. (MHz)	Meter Reading (dBuV)	Antenna Height (cm)	Azimuth (degrees)	Quasi pk or AVG (dBuV)		Distance Factor (dB)	Cable Factor (dB)	Ant. Factor (dB)	Corrected Reading (dBuV)	Limits (dBuV)	Diff (dB) +=FAIL	Comments
5755.00	74.67	100	225			9.54	3.16	35.25	103.54			Ch. 151
5755.00				55.67	A	9.54	3.16	35.25	84.54			
5795.00	75.50	100	225			9.54	3.17	35.26	104.39			Ch. 159
5795.00				57.00	A	9.54	3.17	35.26	85.89			

RADIATED EMISSIONS - Vertical Antenna Polarization												
Freq. (MHz)	Meter Reading (dBuV)	Antenna Height (cm)	Azimuth (degrees)	Quasi pk or AVG (dBuV)		Distance Factor (dB)	Cable Factor (dB)	Ant. Factor (dB)	Corrected Reading (dBuV)	Limits (dBuV)	Diff (dB) +=FAIL	Comments
5755.00	74.17	100	225			9.54	3.16	35.05	102.84			Ch. 151
5755.00				55.00	A	9.54	3.16	35.05	83.67			
5795.00	72.17	100	225			9.54	3.17	35.08	100.88			Ch. 159
5795.00				54.17	A	9.54	3.17	35.08	82.88			

NOTE: Fundamental signals measured at 1 meter and extrapolated to 3 meters to calculate the radiated band edge field strengths.



Radiated Emissions Test Results (Continued)

*Band Edge Field Strength Measurements in 802.11n mode 40MHz Wide (5745-5825 MHz)
Channels 151 & 159
Continuous TX at Chain B Antenna port with Sony IRX-3980 Antennas
Aegis Labs, Inc. File #: INTEL-070320-05*

RADIATED EMISSIONS - Horizontal Antenna Polarization

<i>Freq. (MHz)</i>	<i>Meter Reading (dBuV)</i>	<i>Antenna Height (cm)</i>	<i>Azimuth (degrees)</i>	<i>Quasi pk or AVG (dBuV)</i>	<i>Distance Factor (dB)</i>	<i>Cable Factor (dB)</i>	<i>Ant. Factor (dB)</i>	<i>Corrected Reading (dBuV)</i>	<i>Limits (dBuV)</i>	<i>Diff (dB) +=FAIL</i>	<i>Comments</i>
5725.00	47.00	100	225		9.54	3.15	35.25	75.85	83.54	-7.69	Ch. 151
5850.00	33.67	100	225		9.54	3.19	35.27	62.59	84.39	-21.80	Ch. 159

RADIATED EMISSIONS - Vertical Antenna Polarization

<i>Freq. (MHz)</i>	<i>Meter Reading (dBuV)</i>	<i>Antenna Height (cm)</i>	<i>Azimuth (degrees)</i>	<i>Quasi pk or AVG (dBuV)</i>	<i>Distance Factor (dB)</i>	<i>Cable Factor (dB)</i>	<i>Ant. Factor (dB)</i>	<i>Corrected Reading (dBuV)</i>	<i>Limits (dBuV)</i>	<i>Diff (dB) +=FAIL</i>	<i>Comments</i>
5725.00	46.17	100	225		9.54	3.15	35.04	74.81	82.84	-8.03	Ch. 151
5850.00	30.83	100	225		9.54	3.19	35.11	59.59	80.88	-21.29	Ch. 159

NOTE: The “Band Edge Field Strength” was calculated using the “Radiated Fundamental” measurements.



Radiated Emissions Test Results (Continued)

*Spurious Emissions Measurements in 802.11n mode 40MHz Wide (5745-5825 MHz)
Channels 151 & 159
Continuous TX at Chain B Antenna port with Sony IRX-3980 Antennas
Aegis Labs, Inc. File #: INTEL-070320-10*

RADIATED EMISSIONS - Horizontal Antenna Polarization

Freq. (MHz)	Meter Reading (dBuV)	Antenna Height (cm)	Azimuth (degrees)	Quasi pk or AVG (dBuV)		Preamp Factor (dB)	Cable Factor (dB)	Ant. Factor (dB)	Corrected Reading (dBuV)	Limits (dBuV)	Diff (dB) +=FAIL	Comments
3836.68	57.00	100	225			50.78	2.57	33.14	41.93	74.00	-32.07	Ch. 151
3836.68				47.35	A	50.78	2.57	33.14	32.28	54.00	-21.72	
11509.91	62.50	100	180			50.54	4.64	39.20	55.81	74.00	-18.19	
11509.91				49.39	A	50.54	4.64	39.20	42.70	54.00	-11.30	
3863.36	59.83	100	225			50.78	2.58	33.20	44.83	74.00	-29.17	Ch.159
3863.36				48.86	A	50.78	2.58	33.20	33.86	54.00	-20.14	
11589.56	62.00	100	225			50.60	4.65	39.24	55.29	74.00	-18.71	
11589.56				48.20	A	50.60	4.65	39.24	41.49	54.00	-12.51	

RADIATED EMISSIONS - Vertical Antenna Polarization

Freq. (MHz)	Meter Reading (dBuV)	Antenna Height (cm)	Azimuth (degrees)	Quasi pk or AVG (dBuV)		Preamp Factor (dB)	Cable Factor (dB)	Ant. Factor (dB)	Corrected Reading (dBuV)	Limits (dBuV)	Diff (dB) +=FAIL	Comments
3836.68	59.00	100	135			50.78	2.57	32.78	43.56	74.00	-30.44	Ch. 151
3836.68				49.10	A	50.78	2.57	32.78	33.66	54.00	-20.34	
11509.91	66.67	100	180			50.54	4.64	39.20	59.98	74.00	-14.02	
11509.91				51.97	A	50.54	4.64	39.20	45.28	54.00	-8.72	
3863.34	59.83	100	135			50.78	2.58	32.84	44.47	74.00	-29.53	Ch.159
3863.34				49.86	A	50.78	2.58	32.84	34.50	54.00	-19.50	
11590.07	67.17	100	180			50.60	4.65	39.24	60.46	74.00	-13.54	
11590.07				52.69	A	50.60	4.65	39.24	45.98	54.00	-8.02	



Radiated Emissions Test Results (Continued)

*Spurious Emissions Measurements in 802.11n mode 40MHz Wide (5745-5825 MHz)
Channels 151 & 159
Continuous RX at Chain B Antenna port with Sony IRX-3980 Antennas
Aegis Labs, Inc. File #: INTEL-070320-10*

RADIATED EMISSIONS - Horizontal Antenna Polarization

Freq. (MHz)	Meter Reading (dBuV)	Antenna Height (cm)	Azimuth (degrees)	Quasi pk or AVG (dBuV)		Preamp Factor (dB)	Cable Factor (dB)	Ant. Factor (dB)	Corrected Reading (dBuV)	Limits (dBuV)	Diff (dB) +=FAIL	Comments
3836.66	56.67	100	225			50.78	2.57	33.14	41.60	74.00	-32.40	Ch. 151
3836.66				46.49	A	50.78	2.57	33.14	31.42	54.00	-22.58	
3863.33	57.67	100	225			50.78	2.58	33.20	42.67	74.00	-31.33	Ch.159
3863.33				46.59	A	50.78	2.58	33.20	31.59	54.00	-22.41	

RADIATED EMISSIONS - Vertical Antenna Polarization

Freq. (MHz)	Meter Reading (dBuV)	Antenna Height (cm)	Azimuth (degrees)	Quasi pk or AVG (dBuV)		Preamp Factor (dB)	Cable Factor (dB)	Ant. Factor (dB)	Corrected Reading (dBuV)	Limits (dBuV)	Diff (dB) +=FAIL	Comments
3836.66	56.83	100	225			50.78	2.57	33.14	41.76	74.00	-32.24	Ch. 151
3836.66				48.26	A	50.78	2.57	33.14	33.19	54.00	-20.81	
3863.33	58.17	100	180			50.78	2.58	32.84	42.81	74.00	-31.19	Ch.159
3863.33				47.73	A	50.78	2.58	32.84	32.37	54.00	-21.63	



Radiated Emissions Test Results (Continued)

*Fundamental Measurements in 802.11n mode 40MHz Wide (5745-5825 MHz)
 Channels 151 & 159
 Continuous TX at Dual Chain AB Antenna port with Sony IRX-3980 Antennas
 Aegis Labs, Inc. File #: INTEL-070320-06*

RADIATED EMISSIONS - Horizontal Antenna Polarization												
Freq. (MHz)	Meter Reading (dBuV)	Antenna Height (cm)	Azimuth (degrees)	Quasi pk or AVG (dBuV)		Distance Factor (dB)	Cable Factor (dB)	Ant. Factor (dB)	Corrected Reading (dBuV)	Limits (dBuV)	Diff (dB) +=FAIL	Comments
5755.00	72.50	100	225			9.54	3.16	35.25	101.37			Ch. 151
5755.00				48.17	A	9.54	3.16	35.25	77.04			
5795.00	73.17	100	225			9.54	3.17	35.26	102.06			Ch. 159
5795.00				48.67	A	9.54	3.17	35.26	77.56			

RADIATED EMISSIONS - Vertical Antenna Polarization												
Freq. (MHz)	Meter Reading (dBuV)	Antenna Height (cm)	Azimuth (degrees)	Quasi pk or AVG (dBuV)		Distance Factor (dB)	Cable Factor (dB)	Ant. Factor (dB)	Corrected Reading (dBuV)	Limits (dBuV)	Diff (dB) +=FAIL	Comments
5755.00	70.50	100	225			9.54	3.16	35.05	99.17			Ch. 151
5755.00				46.17	A	9.54	3.16	35.05	74.84			
5795.00	70.17	100	225			9.54	3.17	35.08	98.88			Ch. 159
5795.00				46.17	A	9.54	3.17	35.08	74.88			

NOTE: Fundamental signals measured at 1 meter and extrapolated to 3 meters to calculate the radiated band edge field strengths.



Radiated Emissions Test Results (Continued)

*Band Edge Field Strength Measurements in 802.11n mode 40MHz Wide (5745-5825 MHz)
Channels 151 & 159
Continuous TX at Dual Chain AB Antenna port with Sony IRX-3980 Antennas
Aegis Labs, Inc. File #: INTEL-070320-06*

RADIATED EMISSIONS - Horizontal Antenna Polarization

Freq. (MHz)	Meter Reading (dBuV)	Antenna Height (cm)	Azimuth (degrees)	Quasi pk or AVG (dBuV)	Distance Factor (dB)	Cable Factor (dB)	Ant. Factor (dB)	Corrected Reading (dBuV)	Limits (dBuV)	Diff (dB) +=FAIL	Comments
5725.00	38.50	100	225		9.54	3.15	35.25	67.35	81.37	-14.02	Ch. 151
5850.00	30.17	100	225		9.54	3.19	35.27	59.09	82.06	-22.97	Ch. 159

RADIATED EMISSIONS - Vertical Antenna Polarization

Freq. (MHz)	Meter Reading (dBuV)	Antenna Height (cm)	Azimuth (degrees)	Quasi pk or AVG (dBuV)	Distance Factor (dB)	Cable Factor (dB)	Ant. Factor (dB)	Corrected Reading (dBuV)	Limits (dBuV)	Diff (dB) +=FAIL	Comments
5725.00	35.00	100	225		9.54	3.15	35.04	63.64	79.17	-15.53	Ch. 151
5850.00	29.50	100	225		9.54	3.19	35.11	58.26	78.88	-20.62	Ch. 159

NOTE: The “Band Edge Field Strength” was calculated using the “Radiated Fundamental” measurements.



Radiated Emissions Test Results (Continued)

*Spurious Emissions Measurements in 802.11n mode 40MHz Wide (5745-5825 MHz)
Channels 151 & 159
Continuous TX at Dual Chain AB Antenna port with Sony IRX-3980 Antennas
Aegis Labs, Inc. File #: INTEL-070320-11*

RADIATED EMISSIONS - Horizontal Antenna Polarization

Freq. (MHz)	Meter Reading (dBuV)	Antenna Height (cm)	Azimuth (degrees)	Quasi pk or AVG (dBuV)		Preamp Factor (dB)	Cable Factor (dB)	Ant. Factor (dB)	Corrected Reading (dBuV)	Limits (dBuV)	Diff (dB) +=FAIL	Comments
3836.78	53.00	100	225			50.78	2.57	33.14	37.93	74.00	-36.07	Ch. 151
3836.78				41.83	A	50.78	2.57	33.14	26.76	54.00	-27.24	
11509.71	52.50	100	180			50.54	4.64	39.20	45.81	74.00	-28.19	
11509.71				39.77	A	50.54	4.64	39.20	33.08	54.00	-20.92	
3863.46	59.67	100	135			50.78	2.58	33.20	44.67	74.00	-29.33	Ch.159
3863.46				43.23	A	50.78	2.58	33.20	28.23	54.00	-25.77	
11589.56	53.50	100	180			50.60	4.65	39.24	46.79	74.00	-27.21	
11589.56				40.35	A	50.60	4.65	39.24	33.64	54.00	-20.36	

RADIATED EMISSIONS - Vertical Antenna Polarization

Freq. (MHz)	Meter Reading (dBuV)	Antenna Height (cm)	Azimuth (degrees)	Quasi pk or AVG (dBuV)		Preamp Factor (dB)	Cable Factor (dB)	Ant. Factor (dB)	Corrected Reading (dBuV)	Limits (dBuV)	Diff (dB) +=FAIL	Comments
3836.81	53.50	100	180			50.78	2.57	32.78	38.06	74.00	-35.94	Ch. 151
3836.81				42.87	A	50.78	2.57	32.78	27.43	54.00	-26.57	
11509.66	55.17	100	180			50.54	4.64	39.20	48.48	74.00	-25.52	
11509.66				41.32	A	50.54	4.64	39.20	34.63	54.00	-19.37	
3863.44	57.83	100	180			50.78	2.58	32.84	42.47	74.00	-31.53	Ch.159
3863.44				42.73	A	50.78	2.58	32.84	27.37	54.00	-26.63	
11590.07	55.83	100	180			50.60	4.65	39.24	49.12	74.00	-24.88	
11590.07				41.65	A	50.60	4.65	39.24	34.94	54.00	-19.06	



PEAK TRANSMIT POWER

CLIENT:	Intel Corporation	DATE:	03/29/07
EUT:	Intel Wireless WiFi Link 4965AGN	PROJECT NUMBER:	INTEL-070320
MODEL NUMBER:	4965AGN	TEST ENGINEER:	BM/JC
SERIAL NUMBER:	0013E804612B	SITE #:	1
CONFIGURATION:	Tested installed in the host computer's mini PCI slot.	TEMPERATURE:	23 deg. C
		HUMIDITY:	22% RH
		TIME:	2:00 PM

Description:	The maximum peak output power of the intentional radiator shall not exceed 1 watt.
Results:	Passed (See Data Sheet)
Note:	Conducted Emissions Measurements were performed on the EUT with power supply set at the following voltage and frequency. <ul style="list-style-type: none">• 120VAC / 60 Hz.

Peak Transmit Power Limits	
Frequency (MHz)	Output Power (W)
5745-5825	1
2412-2462	1



Peak Transmit Power (Continued)

Mode	Channel	Frequency (MHz)	Chain	Data Rate (Mbps)	Average Power (dBm)	Average Power (mW)	Peak Power (dBm)	Peak Power (mW)
802.11a	149	5745	A	6	17.55	56.88	19.61	91.40
802.11a	157	5785	A	6	17.43	55.33	19.71	93.53
802.11a	165	5825	A	6	17.56	57.01	19.91	97.94
802.11a	149	5745	B	6	17.48	55.97	20.21	104.94
802.11a	157	5785	B	6	17.57	57.14	20.31	107.39
802.11a	165	5825	B	6	17.46	55.71	20.31	107.39
802.11b	1	2412	A	1	15.44	34.98	19.07	80.68
802.11b	6	2437	A	1	15.59	36.21	19.24	83.90
802.11b	11	2462	A	1	16.61	45.79	20.03	100.64
802.11b	1	2412	B	1	15.40	34.66	18.73	74.61
802.11b	6	2437	B	1	15.57	36.04	18.88	77.23
802.11b	11	2462	B	1	16.63	46.00	19.94	98.58
802.11g	1	2412	A	6	16.40	43.65	23.80	239.86
802.11g	6	2437	A	6	17.60	57.54	23.83	241.52
802.11g	11	2462	A	6	16.58	45.49	23.48	222.82
802.11g	1	2412	B	6	16.47	44.36	23.54	225.92
802.11g	6	2437	B	6	17.45	55.59	23.63	230.65
802.11g	11	2462	B	6	16.56	45.29	23.52	224.88
802.11n	149	5745	A	HT0	17.63	57.94	20.11	102.56
802.11n	157	5785	A	HT0	17.43	55.33	20.91	123.30
802.11n	165	5825	A	HT0	17.52	56.49	20.41	109.89
802.11n	149	5745	B	HT0	17.51	56.36	20.21	104.94
802.11n	157	5785	B	HT0	17.38	54.70	20.61	115.07
802.11n	165	5825	B	HT0	17.45	55.59	20.31	107.39
802.11n	1	2412	A	HT0	15.61	36.39	23.55	226.44
802.11n	6	2437	A	HT0	15.52	35.64	23.37	217.25
802.11n	11	2462	A	HT0	15.57	36.05	23.28	212.79
802.11n	1	2412	B	HT0	15.48	35.31	23.27	212.30
802.11n	6	2437	B	HT0	15.53	35.72	23.39	218.25
802.11n	11	2462	B	HT0	15.51	35.56	23.19	208.43
802.11n (40MHz)	151(F)	5755	A	HT0	17.28	53.45	18.51	70.95
802.11n (40MHz)	159(F)	5795	A	HT0	17.49	56.09	18.11	64.70
802.11n (40MHz)	151(F)	5755	B	HT0	17.38	54.69	18.41	69.33
802.11n (40MHz)	159(F)	5795	B	HT0	17.46	55.71	18.21	66.21

NOTE: The output power measurement is conducted.



Peak Transmit Power (Continued)

Mode	Channel	Freq. (MHz)	Data Rate (Mbps)	Avg. Power (dBm) Ch. A	Avg. Power (mW) Ch. A	Peak Power (dBm) Ch. A	Peak Power (mW) Ch. A	Avg. Power (dBm) Ch. B	Avg. Power (mW) Ch. B	Peak Power (dBm) Ch. B	Peak Power (mW) Ch. B
802.11n (20MHz)	1	2412	HT 8	14.55	28.49	23.70	234.28	14.39	27.46	23.53	225.29
802.11n (20MHz)	6	2437	HT 8	14.41	27.59	23.62	230.01	14.37	27.34	23.60	228.95
802.11n (20MHz)	11	2462	HT 8	14.57	28.62	23.66	232.14	14.29	26.84	23.64	231.07
802.11n (20MHz)	149	5745	HT 8	14.48	28.04	19.79	95.22	14.29	26.84	20.39	109.33
802.11n (20MHz)	157	5785	HT 8	14.50	28.17	20.59	114.48	14.36	27.27	21.49	140.85
802.11n (20MHz)	165	5825	HT 8	14.43	27.72	21.49	140.85	14.36	27.27	22.09	161.71
802.11n (40MHz)	151(F)	5755	HT 8	14.62	28.98	19.24	83.97	14.65	29.18	19.66	92.50
802.11n (40MHz)	159 (F)	5795	HT 8	14.58	28.72	19.34	85.93	14.45	27.87	20.04	100.95

Mode	Channel	Freq. (MHz)	Data Rate (Mbps)	Aggregate Avg. Output Power (dBm) Ch. A + B	Aggregate Avg. Output Power (mW) Ch. A + B	Aggregate Peak Output Power (dBm) Ch. A + B	Aggregate Peak Output Power (mW) Ch. A + B
802.11n (20MHz)	1	2412	HT 8	17.48	55.96	26.62	459.57
802.11n (20MHz)	6	2437	HT 8	17.40	54.93	26.62	458.96
802.11n (20MHz)	11	2462	HT 8	17.44	55.46	26.66	463.20
802.11n (20MHz)	149	5745	HT 8	17.39	54.88	23.11	204.55
802.11n (20MHz)	157	5785	HT 8	17.44	55.44	24.07	255.33
802.11n (20MHz)	165	5825	HT 8	17.40	54.99	24.81	302.56
802.11n (40MHz)	151(F)	5755	HT 8	17.65	58.16	22.47	176.47
802.11n (40MHz)	159 (F)	5795	HT 8	17.53	56.59	22.72	186.88

(F) = Fat Channel



APPENDIX B

MODIFICATIONS AND RECOMMENDATIONS

1.0	NONE