

FCC Co-Location Test Report

FCC ID : I88WAC6502D-E
Equipment : 802.11 ac Unified Pro Access Point
Model No. : WAC6502D-S, WAC6502D-E
Brand Name : ZyXEL
Applicant : ZyXEL Communications Corporation
Address : No. 2, Gongye E. 9th Road, Hsinchu Science
Park, Hsinchu, Taiwan
Standard : 47 CFR FCC Part 15.247
47 CFR FCC Part 15.407
Received Date : Sep. 18, 2014
Tested Date : Sep. 23 ~ Oct. 31, 2014

We, International Certification Corp., would like to declare that the tested sample has been evaluated and in compliance with the requirement of the above standards. The test results contained in this report refer exclusively to the product. It may be duplicated completely for legal use with the approval of the applicant. It shall not be reproduced except in full without the written approval of our laboratory.

Approved & Reviewed by:

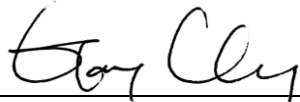

Gary Chang / Manager



Testing Laboratory
2732

Table of Contents

1	GENERAL DESCRIPTION	5
1.1	Information.....	5
1.2	The Equipment List	6
1.3	Test Standards	7
1.4	Measurement Uncertainty	7
2	TEST CONFIGURATION	8
2.1	Testing Condition	8
2.2	The Worst Test Modes and Channel Details	8
3	TRANSMITTER TEST RESULTS.....	9
3.1	Unwanted Emissions into Restricted Frequency Bands	9
4	TEST LABORATORY INFORMATION	23

Release Record

Report No.	Version	Description	Issued Date
FR491801	Rev. 01	Initial issue	Dec. 01, 2014

Summary of Test Results

FCC Rules	Test Items	Measured	Result
15.247(d) 15.407(b) 15.209	Radiated Emissions	[dBuV/m at 3m]: 3358.00MHz 52.59 (Margin -1.41dB) – AV	Pass

1 General Description

1.1 Information

1.1.1 Product Details

The following models are provided to this EUT.

Brand Name	Model Name	Product Name	Description
ZyXEL	WAC6502D-S	802.11 ac Unified Pro Access Point	With internal antenna
	WAC6502D-E		With external antenna

Note: For both models, 2.4 / 5GHz can transmit simultaneously and share a common antenna thus evaluation of co-location is required.

1.1.2 Antenna Details

Ant. No.	Type	Antenna Connector	Operating Frequencies (MHz) / Antenna Gain (dBi)					Remark
			2400~2483.5	5150~5250	5250~5350	5470~5725	5725~5850	
1	Dipole	RSMA	5	7	7	7	7	For WAC6502D-E
2	Dipole	IPEX	4	6	6	6	6	For WAC6502D-S

Note:

- The antenna connector of PCB board of EUT is IPEX.
- WAC6502D-E has a RSMA connector jack to connect antenna and PCB board of EUT.

1.1.3 Power Supply Type of Equipment under Test (EUT)

Power Supply Type	1. AC Adapter (support unit only.) Brand: DVE Model: DSA-24CA-12 120120 Rating: I/P: 100-240Vac, 50/60Hz, 0.8A O/P: 12Vdc, 2A
	2. POE Injector (support unit for radiated emission test only.) Brand: ZyXEL Model: PoE12-HP Rating: I/P: 100-240V~, 50/60Hz, 1.5A max. O/P: 48Vdc, 42.1W
	3. POE Injector (support unit for conducted emission only.) Brand: PowerDsine 3001GC Model: E018205D G Rating: I/P: 100-240V~, 50/60Hz, 0.5A O/P: 48Vdc, 0.35A

1.1.4 Accessories

N/A

1.2 The Equipment List

Test Item	Radiated Emission				
Test Site	966 chamber 3 / (03CH03-WS)				
Instrument	Manufacturer	Model No.	Serial No.	Calibration Date	Calibration Until
Spectrum Analyzer	Agilent	N9010A	MY53400091	Sep. 16, 2014	Sep. 15, 2015
Receiver	Agilent	N9038A	MY53290044	Jan. 08, 2014	Jan. 07, 2015
Bilog Antenna	SCHWARZBECK	VULB9168	VULB9168-562	Feb. 07, 2014	Feb. 06, 2015
Horn Antenna 1G-18G	SCHWARZBECK	BBHA 9120 D	BBHA 9120 D 1206	Feb. 20, 2014	Feb. 19, 2015
Horn Antenna 18G-40G	SCHWARZBECK	BBHA 9170	BBHA 9170517	Dec. 27, 2013	Dec. 26, 2014
Preamplifier	EMC	EMC02325	980187	Nov. 22, 2013	Nov. 21, 2014
Preamplifier	Agilent	83017A	MY53270014	Sep. 17, 2014	Sep. 16, 2015
Preamplifier	EMC	EMC184045B	980192	Aug. 26, 2014	Aug. 25, 2015
RF cable-3M	HUBER+SUHNER	SUCOFLEX104	MY22620/4	Feb. 19, 2014	Feb. 18, 2015
RF cable-8M	HUBER+SUHNER	SUCOFLEX104	MY22601/4	Feb. 19, 2014	Feb. 18, 2015
RF cable-1M	HUBER+SUHNER	SUCOFLEX104	MY22624/4	Feb. 19, 2014	Feb. 18, 2015
LF cable-0.8M	EMC	EMC8D-NM-NM-800	EMC8D-NM-NM-800-001	Feb. 17, 2014	Feb. 16, 2015
LF cable-3M	EMC	EMC8D-NM-NM-3000	131103	Feb. 17, 2014	Feb. 16, 2015
LF cable-13M	EMC	EMC8D-NM-NM-13000	131104	Feb. 17, 2014	Feb. 16, 2015
Measurement Software	AUDIX	e3	6.120210g	NA	NA

Note: Calibration Interval of instruments listed above is one year.

Loop Antenna	R&S	HFH2-Z2	100330	Nov. 15, 2012	Nov. 14, 2014
--------------	-----	---------	--------	---------------	---------------

Note: Calibration Interval of instruments listed above is two year.

1.3 Test Standards

According to the specification of EUT, the EUT must comply with following standards and KDB documents.

47 CFR FCC Part 15.247

47 CFR FCC Part 15.407

ANSI C63.10-2009

FCC KDB 412172

FCC KDB 789033 D01 General UNII Test procedures v01r03

FCC KDB 558074 D01 DTS Meas Guidance v03r01

FCC KDB 662911 D01 Multiple Transmitter Output v02r01

1.4 Measurement Uncertainty

ISO/IEC 17025 requires that an estimate of the measurement uncertainties associated with the emissions test results be included in the report. The measurement uncertainties given below are based on a 95% confidence level (based on a coverage factor (k=2))

Measurement Uncertainty	
Parameters	Uncertainty
Radiated emission \leq 1GHz	± 3.26 dB
Radiated emission $>$ 1GHz	± 4.94 dB

2 Test Configuration

2.1 Testing Condition

Test Item	Test Site	Ambient Condition	Tested By
Radiated Emissions	03CH03-WS	20-25°C / 64-69%	Haru Yang Anderson Hung

➤ FCC site registration No.: 390588

➤ IC site registration No.: 10807C-1

2.2 The Worst Test Modes and Channel Details

Test item	Modulation Mode	Test Channel	Data rate (Mbps) / MCS	Test Configuration
Radiated Emissions ≤1GHz	2.4G 11b + 5G 11ac VHT40	CH6 + CH159	1Mbps + MCS 0	1-4
Radiated Emissions >1GHz	2.4G 11b + 5G 11ac VHT40	CH6 + CH159	1Mbps + MCS 0	1, 3

NOTE:

1. The following antennas are used on this EUT:
 - 1) Configuration 1: model WAC6502D-S, AC Adapter mode.
 - 2) Configuration 2: model WAC6502D-S, POE mode.
 - 3) Configuration 3: model WAC6502D-E, AC Adapter mode
 - 4) Configuration 4: model WAC6502D-E, POE mode
2. The selected channel is the maximum power channel of each Wi-Fi module

3 Transmitter Test Results

3.1 Unwanted Emissions into Restricted Frequency Bands

3.1.1 Limit of Unwanted Emissions into Restricted Frequency Bands

Restricted Band Emissions Limit			
Frequency Range (MHz)	Field Strength (uV/m)	Field Strength (dBuV/m)	Measure Distance (m)
0.009~0.490	2400/F(kHz)	48.5 - 13.8	300
0.490~1.705	24000/F(kHz)	33.8 - 23	30
1.705~30.0	30	29	30
30~88	100	40	3
88~216	150	43.5	3
216~960	200	46	3
Above 960	500	54	3

Note 1:
Qusai-Peak value is measured for frequency below 1GHz except for 9–90 kHz, 110–490 kHz frequency band. Peak and average value are measured for frequency above 1GHz. The limit on average radio frequency emission is as above table. The limit on peak radio frequency emissions is 20 dB above the maximum permitted average emission limit

Note 2:
Measurements may be performed at a distance other than what is specified provided. When performing measurements at a distance other than that specified, the results shall be extrapolated to the specified distance using an extrapolation factor as below, Frequency at or above 30 MHz: 20 dB/decade Frequency below 30 MHz: 40 dB/decade.

3.1.2 Test Procedures

1. Measurement is made at a semi-anechoic chamber that incorporates a turntable allowing a EUT rotation of 360°. A continuously-rotating, remotely-controlled turntable is installed at the test site to support the EUT and facilitate determination of the direction of maximum radiation for each EUT emission frequency. The EUT is placed at a height of 0.8 m test table above the ground plane.
2. Measurement is made with the antenna positioned in both the horizontal and vertical planes of polarization. The measurement antenna is varied in height (1m ~ 4m) above the reference ground plane to obtain the maximum signal strength. Distance between EUT and antenna is 3 m.
3. This investigation is performed with the EUT rotated 360°, the antenna height scanned between 1 m and 4 m, and the antenna rotated to repeat the measurements for both the horizontal and vertical antenna polarizations.

Note:

1. 120kHz measurement bandwidth of test receiver and Quasi-peak detector is for radiated emission below 1GHz.
2. RBW=1MHz, VBW=3MHz and Peak detector is for peak measured value of radiated emission above 1GHz.
3. RBW=1MHz, VBW=1/T and Peak detector is for average measured value of radiated emission above 1GHz.

3.1.3 Test Setup

Radiated Emissions below 1 GHz

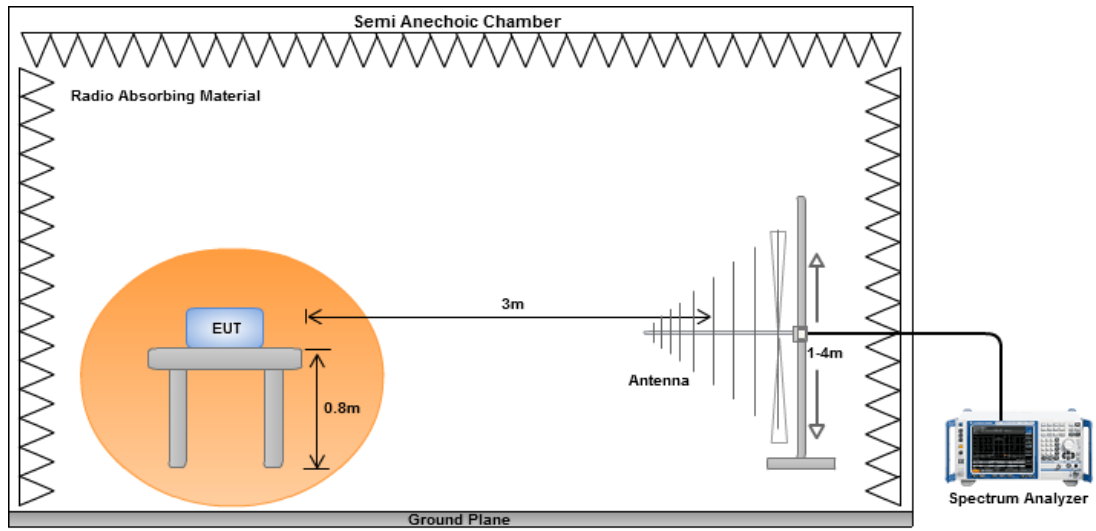

Radiated Emissions above 1 GHz

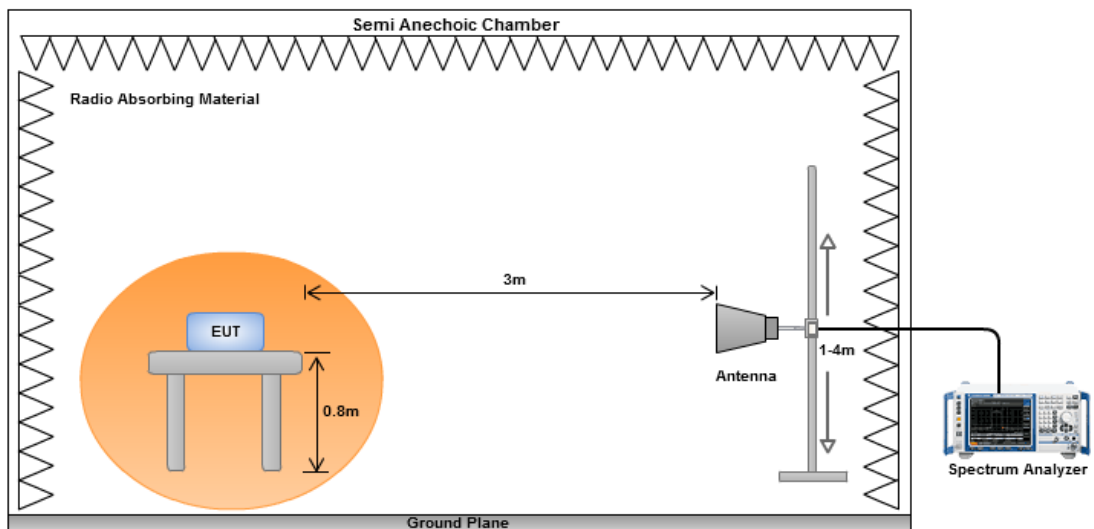

3.1.4 Transmitter Radiated Unwanted Emissions (Below 1GHz)

Modulation	2.4G 11b + 5G 11ac VHT40	Test Channel	CH6 + CH159
Polarization	Horizontal	Test Configuration	1

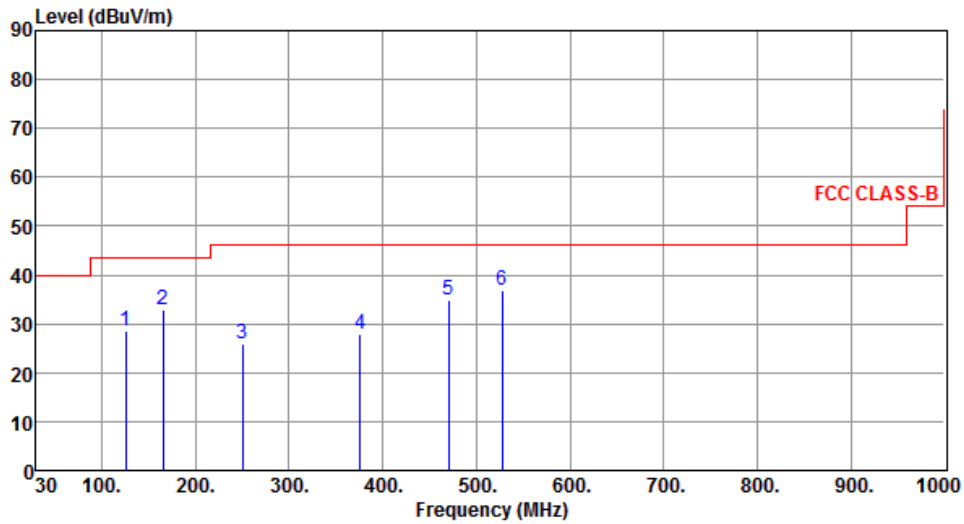

	Freq. MHz	Emission level dBuV/m	Limit dBuV/m	Margin dB	SA reading dBuV	Factor dB	Remark	ANT High cm	Turn Table deg
1	125.26	28.48	43.50	-15.02	43.61	-15.13	Peak	---	---
2	165.30	32.83	43.50	-10.67	46.52	-13.69	Peak	---	---
3	250.35	25.88	46.00	-20.12	40.35	-14.47	Peak	---	---
4	375.97	27.87	46.00	-18.13	38.61	-10.74	Peak	---	---
5	470.43	34.97	46.00	-11.03	43.34	-8.37	Peak	---	---
6	527.86	36.97	46.00	-9.03	44.52	-7.55	Peak	---	---

Note 1: Emission Level (dBuV/m) = SA Reading (dBuV/m) + Factor* (dB)

*Factor includes antenna factor, cable loss and amplifier gain

Note 2: Margin (dB) = Emission level (dBuV/m) – Limit (dBuV/m).

Modulation	2.4G 11b + 5G 11ac VHT40	Test Channel	CH6 + CH159
Polarization	Vertical	Test Configuration	1

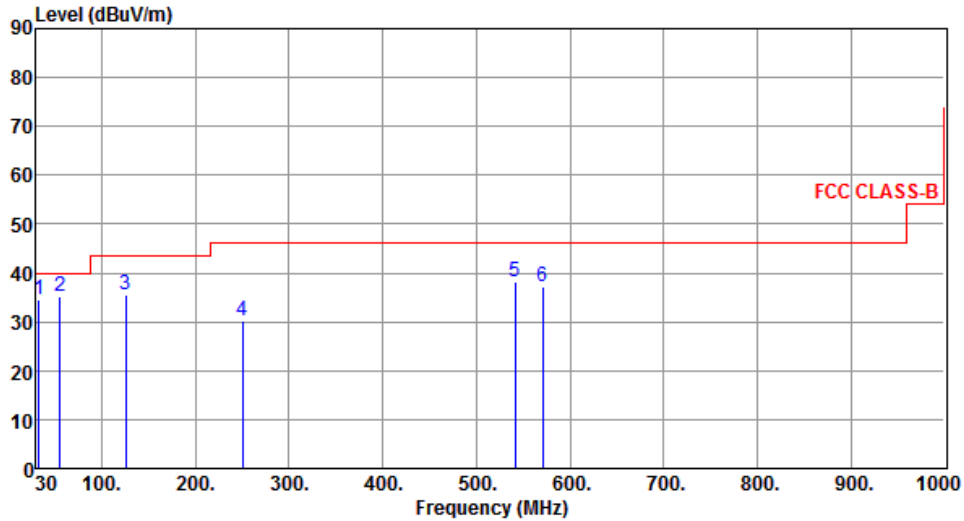

	Freq. MHz	Emission level dBuV/m	Limit dBuV/m	Margin dB	SA reading dBuV	Factor dB	Remark	ANT High cm	Turn Table deg
1	32.64	34.65	40.00	-5.35	48.65	-14.00	Peak	---	---
2	55.27	35.07	40.00	-4.93	48.34	-13.27	Peak	---	---
3	125.33	35.63	43.50	-7.87	50.76	-15.13	Peak	---	---
4	250.64	30.23	46.00	-15.77	44.68	-14.45	Peak	---	---
5	541.44	38.05	46.00	-7.95	45.36	-7.31	Peak	---	---
6	570.48	37.13	46.00	-8.87	43.64	-6.51	Peak	---	---

Note 1: Emission Level (dBuV/m) = SA Reading (dBuV/m) + Factor* (dB)

*Factor includes antenna factor , cable loss and amplifier gain

Note 2: Margin (dB) = Emission level (dBuV/m) – Limit (dBuV/m).

Modulation	2.4G 11b + 5G 11ac VHT40	Test Channel	CH6 + CH159
Polarization	Horizontal	Test Configuration	2

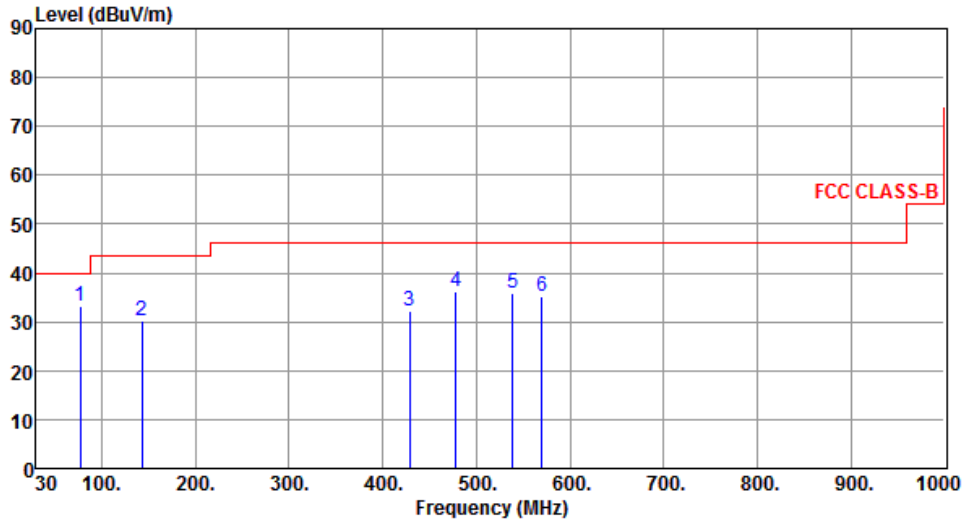

	Freq. MHz	Emission level dBuV/m	Limit dBuV/m	Margin dB	SA reading dBuV	Factor dB	Remark	ANT High cm	Turn Table deg
1	77.45	33.34	40.00	-6.66	50.43	-17.09	Peak	---	---
2	142.64	30.12	43.50	-13.38	43.64	-13.52	Peak	---	---
3	428.68	32.07	46.00	-13.93	41.34	-9.27	Peak	---	---
4	478.25	36.04	46.00	-9.96	44.31	-8.27	Peak	---	---
5	538.62	35.79	46.00	-10.21	43.16	-7.37	Peak	---	---
6	570.41	35.24	46.00	-10.76	41.75	-6.51	Peak	---	---

Note 1: Emission Level (dBuV/m) = SA Reading (dBuV/m) + Factor* (dB)

*Factor includes antenna factor , cable loss and amplifier gain

Note 2: Margin (dB) = Emission level (dBuV/m) – Limit (dBuV/m).

Modulation	2.4G 11b + 5G 11ac VHT40	Test Channel	CH6 + CH159
Polarization	Vertical	Test Configuration	2

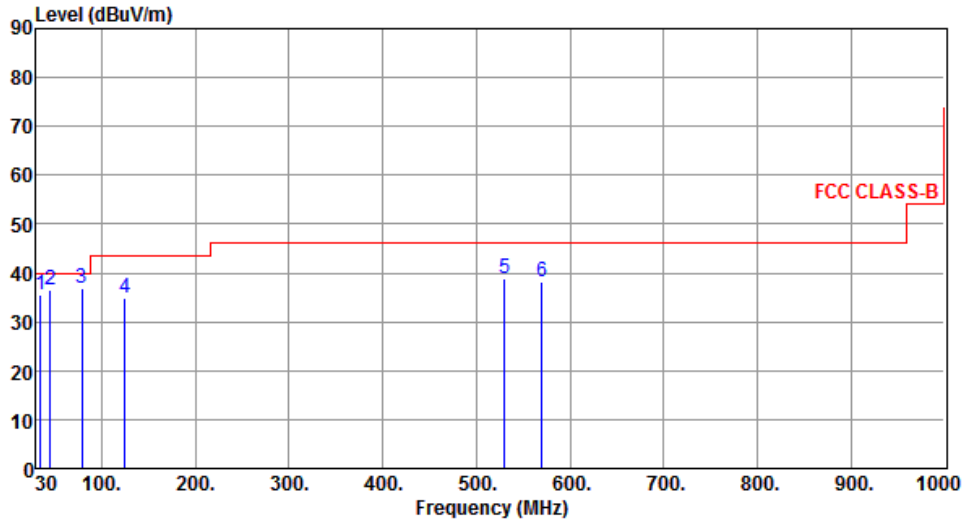

	Freq. MHz	Emission level dBuV/m	Limit dBuV/m	Margin dB	SA reading dBuV	Factor dB	Remark	ANT High cm	Turn Table deg
1	34.85	35.60	40.00	-4.40	49.64	-14.04	Peak	---	---
2	45.44	36.47	40.00	-3.53	49.63	-13.16	QP	---	---
3	78.64	36.94	40.00	-3.06	54.31	-17.37	Peak	---	---
4	125.12	34.96	43.50	-8.54	50.11	-15.15	Peak	---	---
5	529.75	38.80	46.00	-7.20	46.31	-7.51	Peak	---	---
6	570.41	38.11	46.00	-7.89	44.62	-6.51	Peak	---	---

Note 1: Emission Level (dBuV/m) = SA Reading (dBuV/m) + Factor* (dB)

*Factor includes antenna factor , cable loss and amplifier gain

Note 2: Margin (dB) = Emission level (dBuV/m) – Limit (dBuV/m).

Modulation	2.4G 11b + 5G 11ac VHT40	Test Channel	CH6 + CH159
Polarization	Horizontal	Test Configuration	3

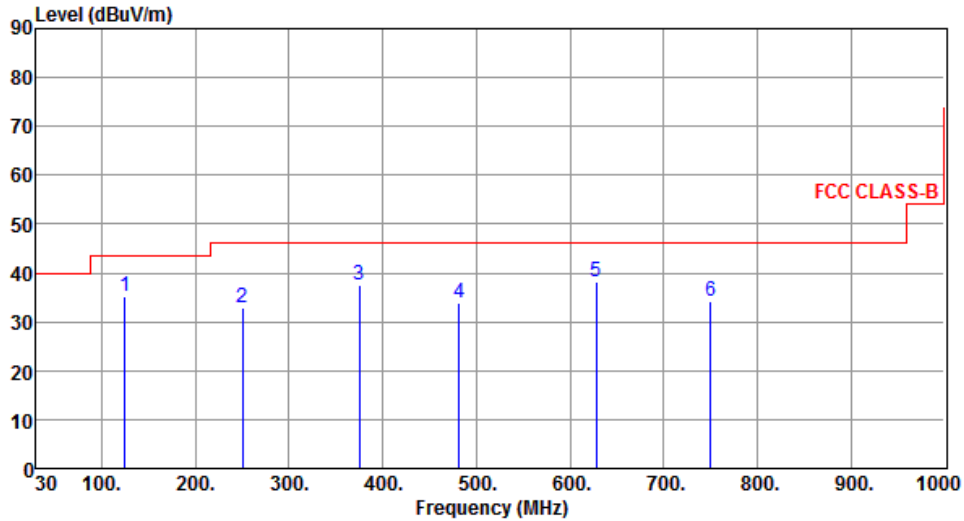

	Freq. MHz	Emission level dBuV/m	Limit dBuV/m	Margin dB	SA reading dBuV	Factor dB	Remark	ANT High cm	Turn Table deg
1	125.06	35.20	43.50	-8.30	50.35	-15.15	Peak	---	---
2	250.20	32.95	46.00	-13.05	47.42	-14.47	Peak	---	---
3	375.42	37.56	46.00	-8.44	48.31	-10.75	Peak	---	---
4	481.60	34.01	46.00	-11.99	42.23	-8.22	Peak	---	---
5	628.27	38.08	46.00	-7.92	43.31	-5.23	Peak	---	---
6	750.28	34.28	46.00	-11.72	37.44	-3.16	Peak	---	---

Note 1: Emission Level (dBuV/m) = SA Reading (dBuV/m) + Factor* (dB)

*Factor includes antenna factor , cable loss and amplifier gain

Note 2: Margin (dB) = Emission level (dBuV/m) – Limit (dBuV/m).

Modulation	2.4G 11b + 5G 11ac VHT40	Test Channel	CH6 + CH159
Polarization	Vertical	Test Configuration	3

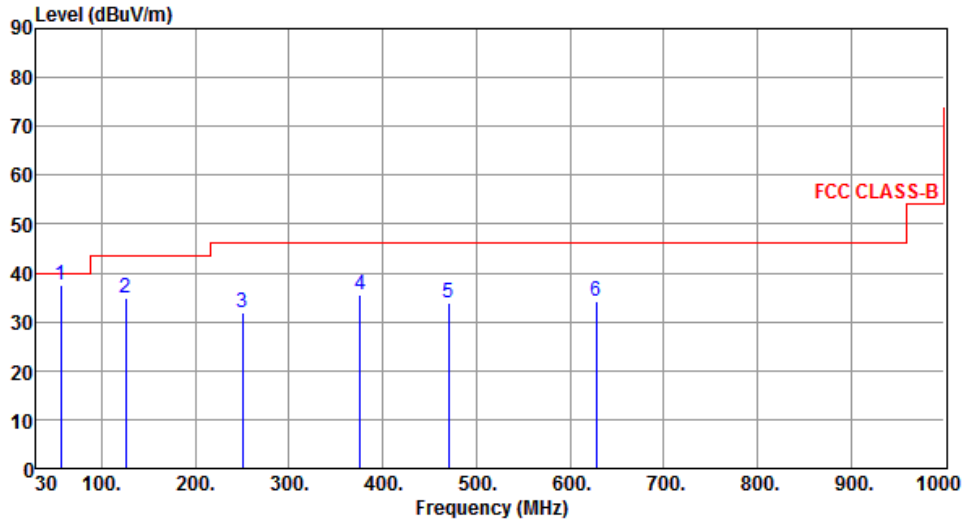

	Freq. MHz	Emission level dBuV/m	Limit dBuV/m	Margin dB	SA reading dBuV	Factor dB	Remark	ANT High cm	Turn Table deg
1	56.31	37.69	40.00	-2.31	51.01	-13.32	Peak	---	---
2	125.42	34.74	43.50	-8.76	49.86	-15.12	Peak	---	---
3	250.26	31.84	46.00	-14.16	46.31	-14.47	Peak	---	---
4	375.66	35.60	46.00	-10.40	46.35	-10.75	Peak	---	---
5	470.38	33.90	46.00	-12.10	42.27	-8.37	Peak	---	---
6	628.16	34.11	46.00	-11.89	39.34	-5.23	Peak	---	---

Note 1: Emission Level (dBuV/m) = SA Reading (dBuV/m) + Factor* (dB)

*Factor includes antenna factor , cable loss and amplifier gain

Note 2: Margin (dB) = Emission level (dBuV/m) – Limit (dBuV/m).

Modulation	2.4G 11b + 5G 11ac VHT40	Test Channel	CH6 + CH159
Polarization	Horizontal	Test Configuration	4

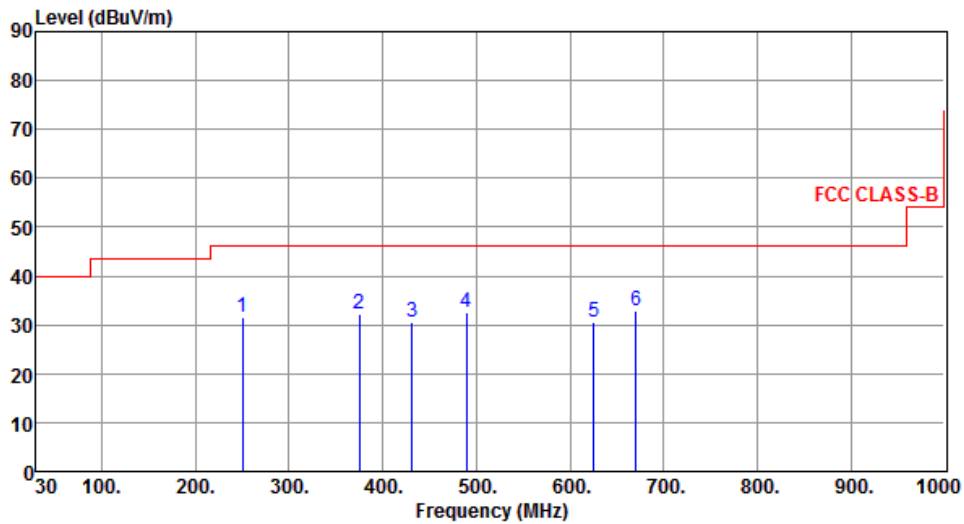

	Freq. MHz	Emission level dBuV/m	Limit dBuV/m	Margin dB	SA reading dBuV	Factor dB	Remark	ANT High cm	Turn Table deg
1	250.10	31.42	46.00	-14.58	46.31	-14.89	Peak	---	---
2	375.42	32.13	46.00	-13.87	43.32	-11.19	Peak	---	---
3	431.02	30.66	46.00	-15.34	40.34	-9.68	Peak	---	---
4	489.35	32.56	46.00	-13.44	41.24	-8.68	Peak	---	---
5	625.30	30.58	46.00	-15.42	36.45	-5.87	Peak	---	---
6	670.42	32.96	46.00	-13.04	38.21	-5.25	Peak	---	---

Note 1: Emission Level (dBuV/m) = SA Reading (dBuV/m) + Factor* (dB)

*Factor includes antenna factor , cable loss and amplifier gain

Note 2: Margin (dB) = Emission level (dBuV/m) – Limit (dBuV/m).

Modulation	2.4G 11b + 5G 11ac VHT40	Test Channel	CH6 + CH159
Polarization	Vertical	Test Configuration	4

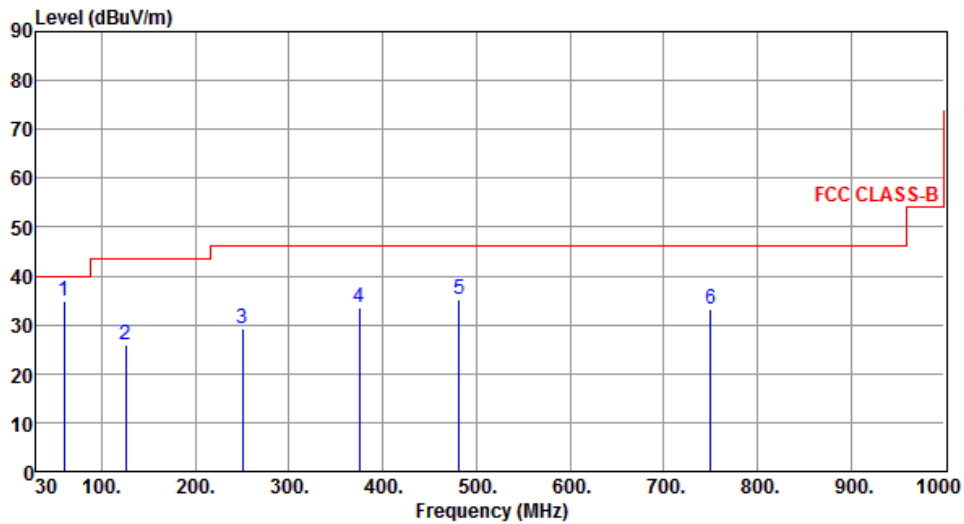

	Freq. MHz	Emission level dBuV/m	Limit dBuV/m	Margin dB	SA reading dBuV	Factor dB	Remark	ANT High cm	Turn Table deg
1	59.64	34.80	40.00	-5.20	48.32	-13.52	Peak	---	---
2	125.64	26.02	43.50	-17.48	41.12	-15.10	Peak	---	---
3	250.31	29.18	46.00	-16.82	43.65	-14.47	Peak	---	---
4	375.42	33.46	46.00	-12.54	44.21	-10.75	Peak	---	---
5	481.56	35.09	46.00	-10.91	43.31	-8.22	Peak	---	---
6	750.34	33.22	46.00	-12.78	36.38	-3.16	Peak	---	---

Note 1: Emission Level (dBuV/m) = SA Reading (dBuV/m) + Factor* (dB)

*Factor includes antenna factor , cable loss and amplifier gain

Note 2: Margin (dB) = Emission level (dBuV/m) – Limit (dBuV/m).

3.1.5 Transmitter Radiated Unwanted Emissions (Above 1GHz)

Modulation	2.4G 11b + 5G 11ac VHT40	Test Channel	CH6 + CH159
Polarization	Horizontal	Test Configuration	1

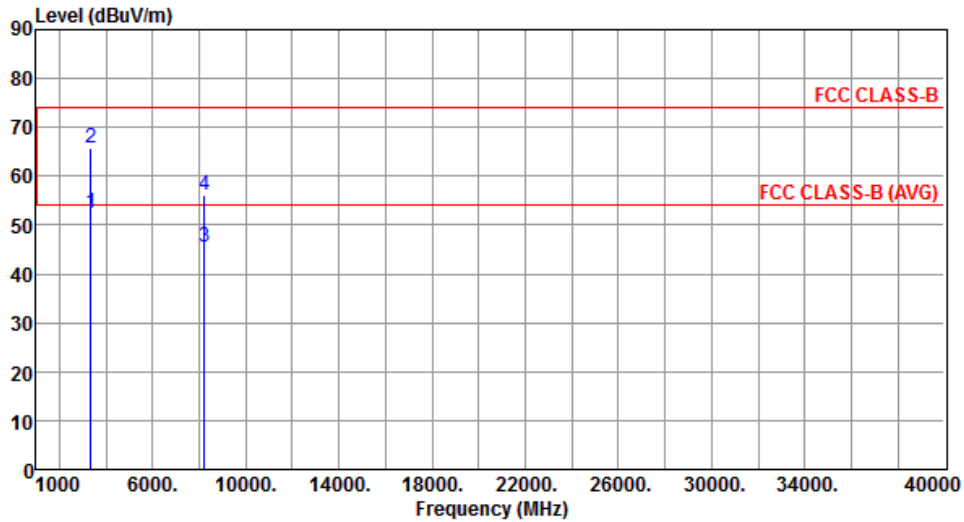

	Freq. MHz	Emission level dBuV/m	Limit dBuV/m	Margin dB	SA reading dBuV	Factor dB	Remark	ANT High cm	Turn Table deg
1	3358.00	52.59	54.00	-1.41	51.48	1.11	Average	---	---
2	3358.00	65.59	74.00	-8.41	64.48	1.11	Peak	---	---
3	8232.00	45.41	54.00	-8.59	33.77	11.64	Average	---	---
4	8232.00	56.24	74.00	-17.76	44.60	11.64	Peak	---	---

Note 1: Emission Level (dBuV/m) = SA Reading (dBuV/m) + Factor* (dB)

*Factor includes antenna factor , cable loss and amplifier gain

Note 2: Margin (dB) = Emission level (dBuV/m) – Limit (dBuV/m).

Modulation	2.4G 11b + 5G 11ac VHT40	Test Channel	CH6 + CH159
Polarization	Vertical	Test Configuration	1

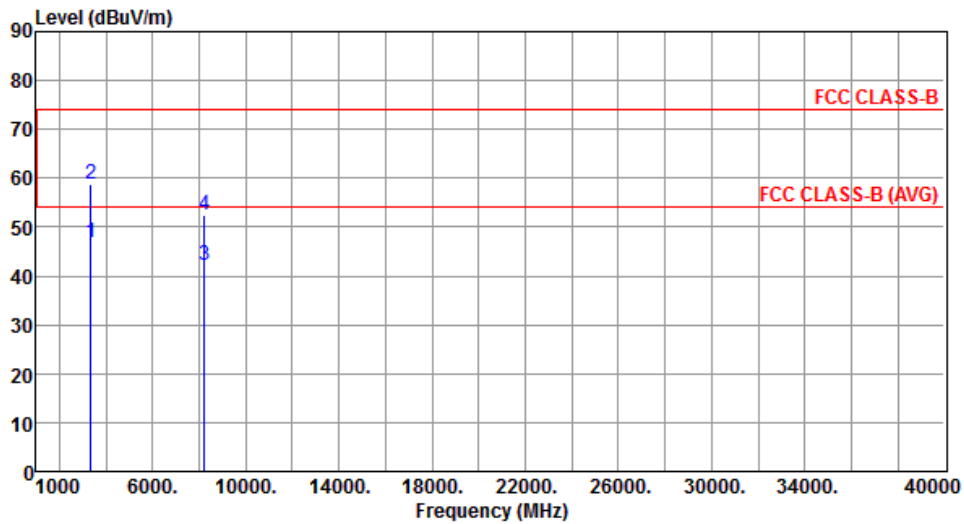

	Freq. MHz	Emission level dBuV/m	Limit dBuV/m	Margin dB	SA reading dBuV	Factor dB	Remark	ANT High cm	Turn Table deg
1	3358.00	46.81	54.00	-7.19	45.70	1.11	Average	---	---
2	3358.00	58.65	74.00	-15.35	57.54	1.11	Peak	---	---
3	8232.00	42.22	54.00	-11.78	30.58	11.64	Average	---	---
4	8232.00	52.49	74.00	-21.51	40.85	11.64	Peak	---	---

Note 1: Emission Level (dBuV/m) = SA Reading (dBuV/m) + Factor* (dB)

*Factor includes antenna factor , cable loss and amplifier gain

Note 2: Margin (dB) = Emission level (dBuV/m) – Limit (dBuV/m).

Modulation	2.4G 11b + 5G 11ac VHT40	Test Channel	CH6 + CH159
Polarization	Horizontal	Test Configuration	3

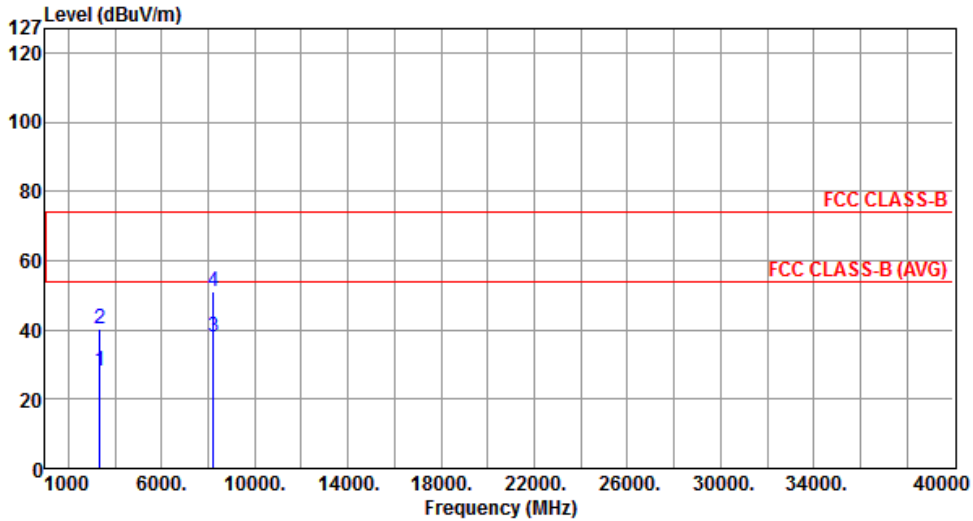

	Freq. MHz	Emission level dBuV/m	Limit dBuV/m	Margin dB	SA reading dBuV	Factor dB	Remark	ANT High cm	Turn Table deg
1	3358.00	27.95	54.00	-26.05	26.84	1.11	Average	---	---
2	3358.00	40.24	74.00	-33.76	39.13	1.11	Peak	---	---
3	8232.00	37.85	54.00	-16.15	26.21	11.64	Average	---	---
4	8232.00	51.03	74.00	-22.97	39.39	11.64	Peak	---	---

Note 1: Emission Level (dBuV/m) = SA Reading (dBuV/m) + Factor* (dB)

*Factor includes antenna factor , cable loss and amplifier gain

Note 2: Margin (dB) = Emission level (dBuV/m) – Limit (dBuV/m).

Modulation	2.4G 11b + 5G 11ac VHT40	Test Channel	CH6 + CH159
Polarization	Vertical	Test Configuration	3

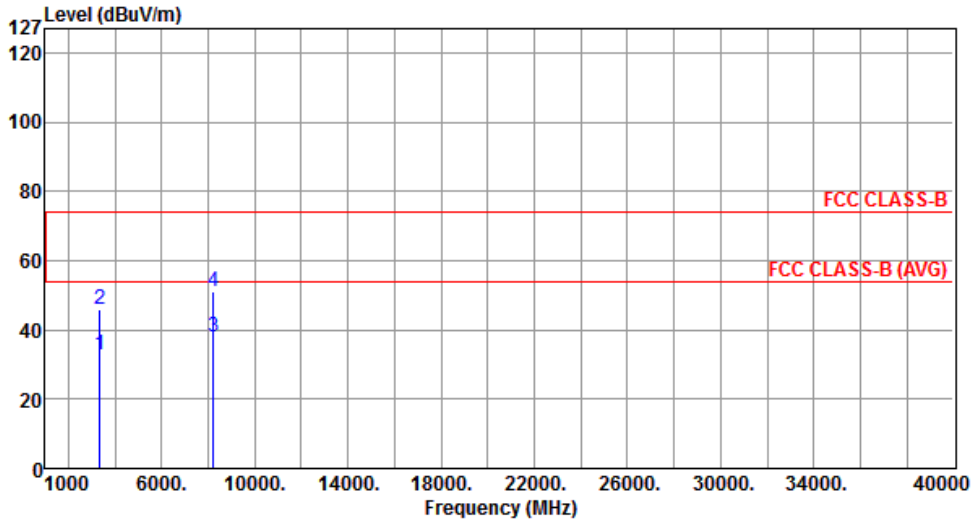

	Freq. MHz	Emission level dBuV/m	Limit dBuV/m	Margin dB	SA reading dBuV	Factor dB	Remark	ANT High cm	Turn Table deg
1	3358.00	33.00	54.00	-21.00	31.89	1.11	Average	---	---
2	3358.00	45.94	74.00	-28.06	44.83	1.11	Peak	---	---
3	8232.00	37.83	54.00	-16.17	26.19	11.64	Average	---	---
4	8232.00	51.18	74.00	-22.82	39.54	11.64	Peak	---	---

Note 1: Emission Level (dBuV/m) = SA Reading (dBuV/m) + Factor* (dB)

*Factor includes antenna factor , cable loss and amplifier gain

Note 2: Margin (dB) = Emission level (dBuV/m) – Limit (dBuV/m).

4 Test laboratory information

Established in 2012, ICC provides foremost EMC & RF Testing and advisory consultation services by our skilled engineers and technicians. Our services employ a wide variety of advanced edge test equipment and one of the widest certification extents in the business.

International Certification Corp, it is our definitive objective is to institute long term, trust-based associations with our clients. The expectation we set up with our clients is based on outstanding service, practical expertise and devotion to a certified value structure. Our passion is to grant our clients with best EMC / RF services by oriented knowledgeable and accommodating staff.

Our Test sites are located at Linkou District and Kwei Shan Hsiang. Location map can be found on our website <http://www.icertifi.com.tw>.

Linkou

Tel: 886-2-2601-1640

No. 30-2, Ding Fwu Tsuen, Lin Kou
District, New Taipei City, Taiwan,
R.O.C.

Kwei Shan

Tel: 886-3-271-8666

No. 3-1, Lane 6, Wen San 3rd
St., Kwei Shan Hsiang, Tao Yuan
Hsien 333, Taiwan, R.O.C.

Kwei Shan Site II

Tel: 886-3-271-8640

No. 14-1, Lane 19, Wen San 3rd
St., Kwei Shan Hsiang, Tao Yuan
Hsien 333, Taiwan, R.O.C.

If you have any suggestion, please feel free to contact us as below information

Tel: 886-3-271-8666

Fax: 886-3-318-0155

Email: ICC_Service@icertifi.com.tw

==END==