

TEST REPORT

Report No.: BCTC2403267399E

Applicant: Sam Ash Music Corporation

Product Name: AH100 Wireless microphone system

Test Model: AH100

Tested Date: 2024-03-27 to 2024-04-28

Issued Date: 2024-04-28

Shenzhen BCTC Testing Co., Ltd.



FCC ID: CCRAH100

Product Name: AH100 Wireless microphone system
Trademark: SAMSON
Model/Type reference: AH100
Prepared For: Sam Ash Music Corporation
Address: 262 Duffy Avenue, Hicksville, NY 11801, United States
Manufacturer: Sam Ash Music Corporation
Address: 262 Duffy Avenue, Hicksville, NY 11801, United States
Prepared By: Shenzhen BCTC Testing Co., Ltd.
Address: 1-2/F., Building B, Pengzhou Industrial Park, No.158, Fuyuan 1st Road, Zhancheng, Fuhai Subdistrict, Bao'an District, Shenzhen, Guangdong, China
Sample Received Date: 2024-03-27
Sample tested Date: 2024-03-27 to 2024-04-28
Issue Date: 2024-04-28
Report No.: BCTC2403267399E
Test Standards: FCC Part74H
ANSI C63.10-2013
ANSI/TIA-603-E:2016
Test Results: PASS

Tested by:



Lei Chen/Project Handler

Approved by:



Zero Zhou/Reviewer

The test report is effective only with both signature and specialized stamp. This result(s) shown in this report refer only to the sample(s) tested. Without written approval of Shenzhen BCTC Testing Co., Ltd, this report can't be reproduced except in full. The tested sample(s) and the sample information are provided by the client.

Table Of Content

Test Report Declaration	Page
1. Version	5
2. Test Summary	6
3. Measurement Uncertainty	7
4. Product Information And Test Setup	8
4.1 Product Information.....	8
4.2 Test Setup Configuration	8
4.3 Support Equipment	8
4.4 Channel List	9
4.5 Test Mode	11
4.6 Test Conditions	11
5. Test Facility And Test Instrument Used.....	12
5.1 Test Facility.....	12
5.2 Test Instrument Used.....	12
6. RF Output Power.....	13
6.1 Block Diagram Of Test Setup.....	13
6.2 Limit	13
6.3 Test Procedure	13
6.4 EUT Operating Conditions	13
6.5 Test Result.....	14
7. Radiated Emissions.....	18
7.1 Block Diagram Of Test Setup.....	18
7.2 Limit	19
7.3 Test Procedure	20
7.4 EUT Operating Conditions	20
7.5 Test Result.....	21
8. Modulation Characteristics	23
8.1 Block Diagram Of Test Setup.....	23
8.2 Limit	23
8.3 Test Procedure	23
8.4 EUT operating Conditions	23
8.5 Test Result.....	23
9. Occupied Bandwidth	26
9.1 Block Diagram Of Test Setup.....	26
9.2 Limit	26
9.3 Test Procedure	26
9.4 EUT Operating Conditions	26
9.5 Test Result.....	27
10. Spurious Emission At Antenna Terminal	37
10.1 Block Diagram Of Test Setup.....	37
10.2 Limit	37
10.3 Test Procedure	37
10.4 EUT Operating Conditions	38
10.5 Test Result.....	38
11. Frequency Stability.....	45

11.1	Block Diagram Of Test Setup.....	45
11.2	Limit	45
11.3	Test Procedure	45
11.4	EUT Operating Conditions	45
11.5	Test Result.....	46
12.	Antenna Requirement	47
12.1	Limit	47
12.2	Test Result.....	47
13.	EUT Photographs.....	48
14.	EUT Test Setup Photographs.....	49

(Note: N/A Means Not Applicable)

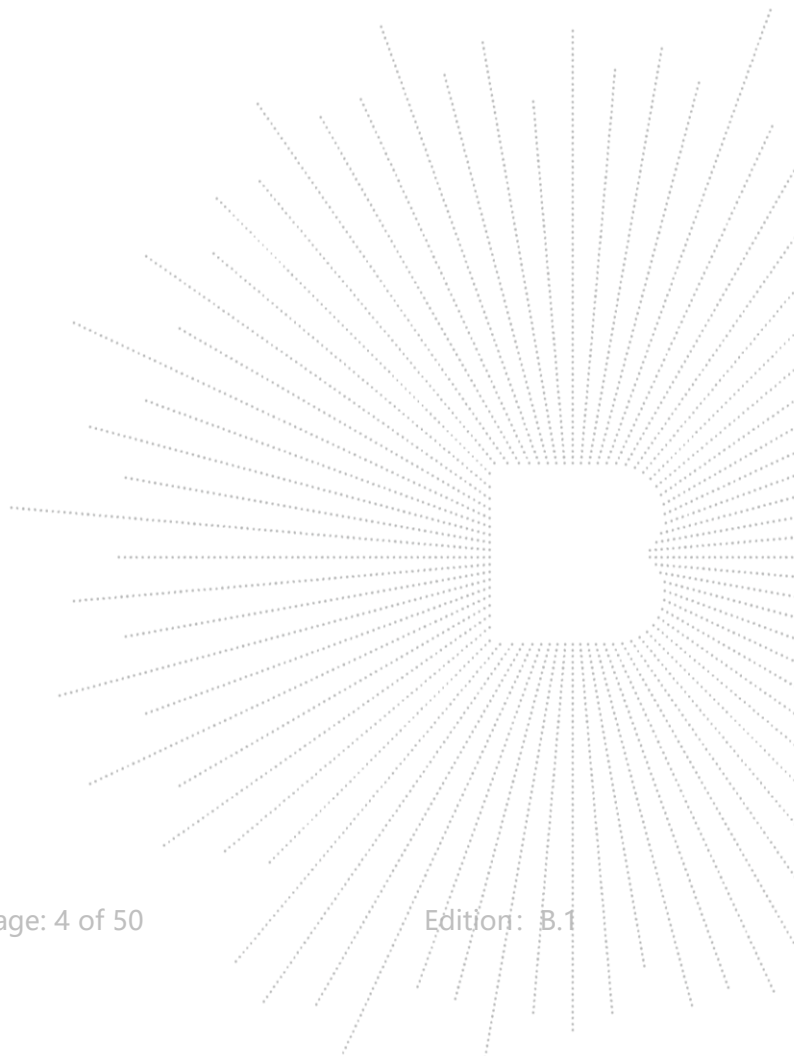

1. Version

Report No.	Issue Date	Description	Approved
BCTC2403267399E	2024-04-28	Original	Valid

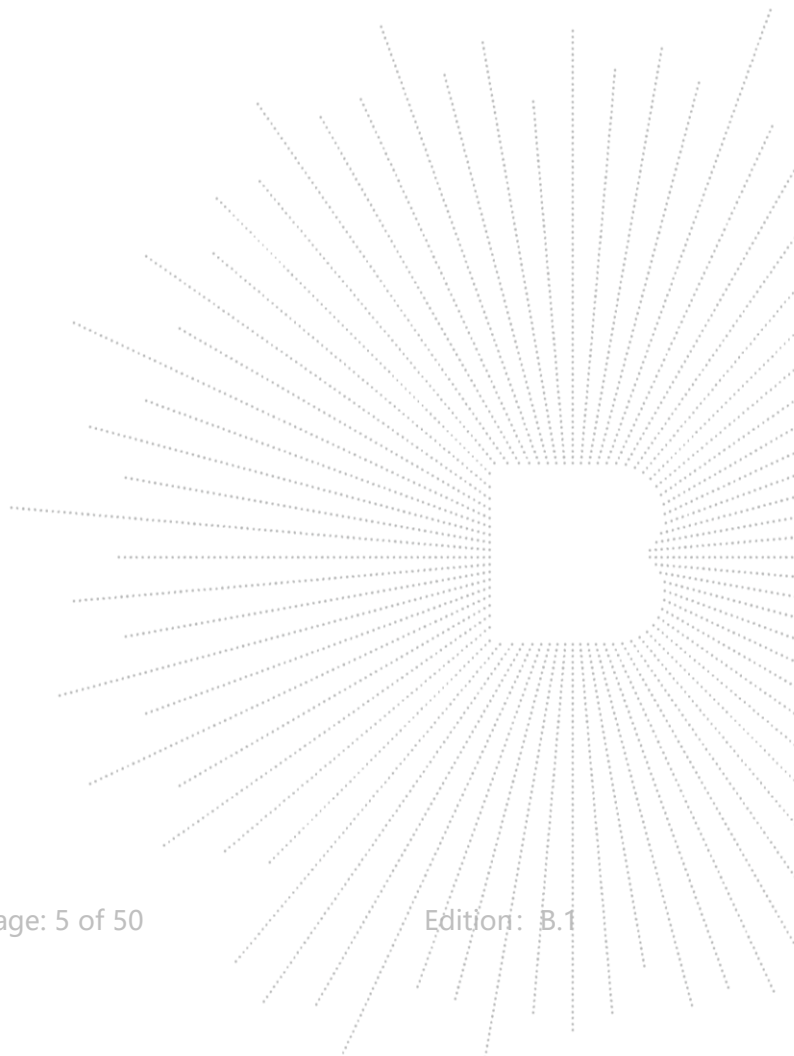

2. Test Summary

The Product has been tested according to the following specifications:

No.	Test Parameter	Clause No.	Results
1	Output Power Measurement	§74.861(e)(1)(ii)	PASS
2	Modulation Characteristics	§74.861(e)(3)	PASS
3	Occupied Bandwidth Emission	§74.861(e)(5)	PASS
4	Radiated Spurious Emission	§74.861(e)(6)	PASS
5	Spurious Emission at Antenna Port	§2.1051	PASS
6	Frequency Stability	§74.861(e)(4)	PASS
NOTE1: N/A (Not Applicable)			

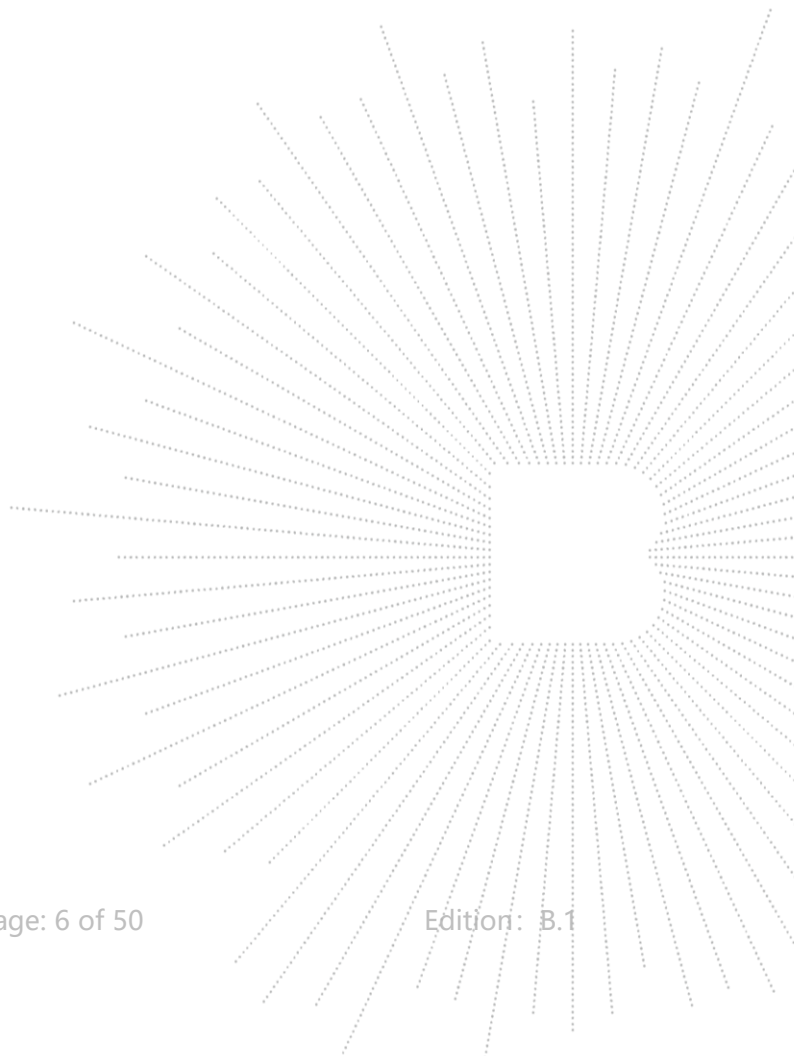

3. Measurement Uncertainty

Where relevant, the following measurement uncertainty levels have been estimated for tests performed on the Product as specified in CISPR 16-4-2. This uncertainty represents an expanded uncertainty expressed at approximately the 95% confidence level using a coverage factor of $k=2$.

No.	Item	Uncertainty
1	3m chamber Radiated spurious emission(9kHz-30MHz)	U=3.7dB
2	3m chamber Radiated spurious emission(30MHz-1GHz)	U=4.3dB
3	3m chamber Radiated spurious emission(1GHz-18GHz)	U=4.5dB
4	3m chamber Radiated spurious emission(18GHz-40GHz)	U=3.34dB
5	Conducted Emission(150kHz-30MHz)	U=3.20dB
6	Conducted Adjacent channel power	U=1.38dB
7	Conducted output power uncertainty Above 1G	U=1.576dB
8	Conducted output power uncertainty below 1G	U=1.28dB
9	humidity uncertainty	U=5.3%
10	Temperature uncertainty	U=0.59°C

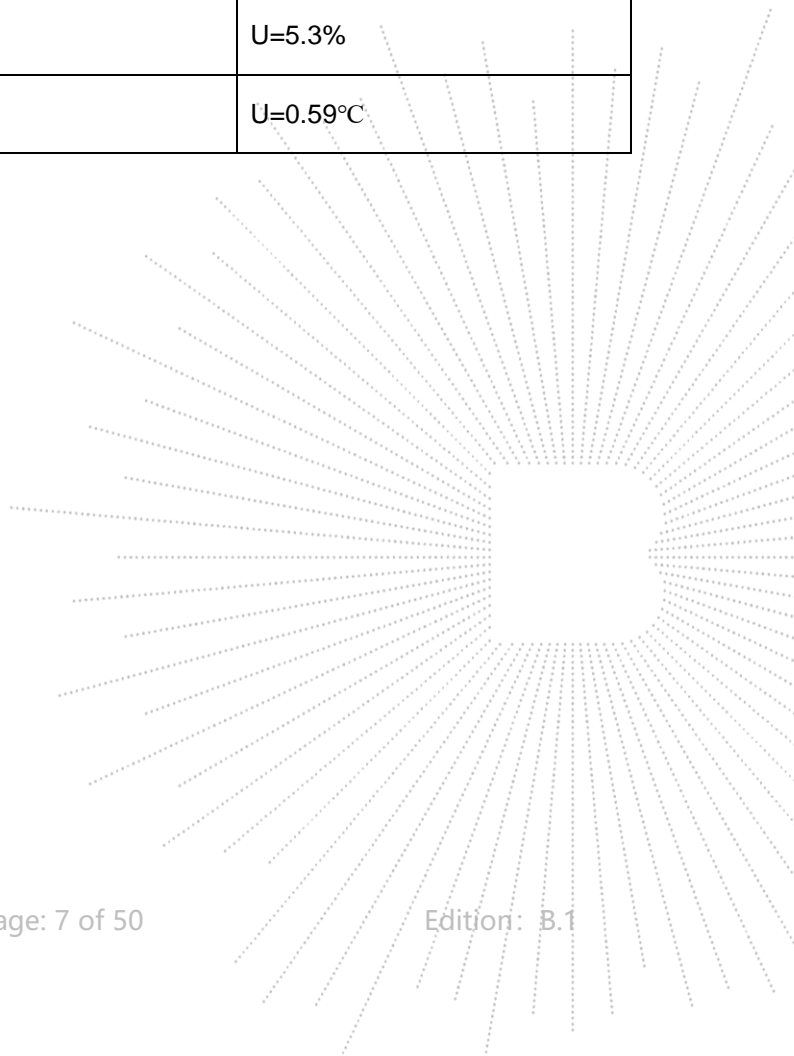

4. Product Information And Test Setup

4.1 Product Information

Model/Type reference:	AH100
Model differences:	N/A
Hardware Version:	V1.0
Software Version:	V1.0
Operation Frequency:	470.125MHz~492.400MHz 500.125MHz~522.400MHz
Type of Modulation:	FM
Number Of Channel	470.125MHz~492.400MHz: 100 Channel 500.125MHz~522.400MHz: 100 Channel
Antenna installation:	Integral Antenna 1.75 dBi
Antenna Gain:	Remark: <input checked="" type="checkbox"/> The antenna gain of the product comes from the antenna report provided by the customer, and the test data is affected by the customer information. <input type="checkbox"/> The antenna gain of the product is provided by the customer, and the test data is affected by the customer information.
Ratings:	DC 5V from USB, DC 3.7V from battery

4.2 Test Setup Configuration

See test photographs attached in *EUT TEST SETUP PHOTOGRAPHS* for the actual connections between Product and support equipment.

Radiated Spurious Emission

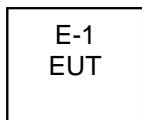

4.3 Support Equipment

No.	Device Type	Brand	Model	Series No.	Note
E-1	AH100 Wireless microphone system	SAMSON	AH100	N/A	EUT

Notes:

- All the equipment/cables were placed in the worst-case configuration to maximize the emission during the test.
- Grounding was established in accordance with the manufacturer's requirements and conditions for the intended use.

4.4 Channel List

470.125MHz~492.400MHz

Channel No.	Frequency (MHz)	Channel No.	Frequency (MHz)	Channel No.	Frequency (MHz)	Channel No.	Frequency (MHz)
00	470.125	25	475.750	50	481.375	75	487.000
01	470.350	26	475.975	51	481.600	76	487.225
02	470.575	27	476.200	52	481.825	77	487.450
03	470.800	28	476.425	53	482.050	78	487.675
04	471.025	29	476.650	54	482.275	79	487.900
05	471.250	30	476.875	55	482.500	80	488.125
06	471.475	31	477.100	56	482.725	81	488.350
07	471.700	32	477.325	57	482.950	82	488.575
08	471.925	33	477.550	58	483.175	83	488.800
09	472.150	34	477.775	59	483.400	84	489.025
10	472.375	35	478.000	60	483.625	85	489.250
11	472.600	36	478.225	61	483.850	86	489.475
12	472.825	37	478.450	62	484.075	87	489.700
13	473.050	38	478.675	63	484.300	88	489.925
14	473.275	39	478.900	64	484.525	89	490.150
15	473.500	40	479.125	65	484.750	90	490.375
16	473.725	41	479.350	66	484.975	91	490.600
17	473.950	42	479.575	67	485.200	92	490.825
18	474.175	43	479.800	68	485.425	93	491.050
19	474.400	44	480.025	69	485.650	94	491.275
20	474.625	45	480.250	70	485.875	95	491.500
21	474.850	46	480.475	71	486.100	96	491.725
22	475.075	47	480.700	72	486.325	97	491.950
23	475.300	48	480.925	73	486.550	98	492.175
24	475.525	49	481.150	74	486.775	99	492.400

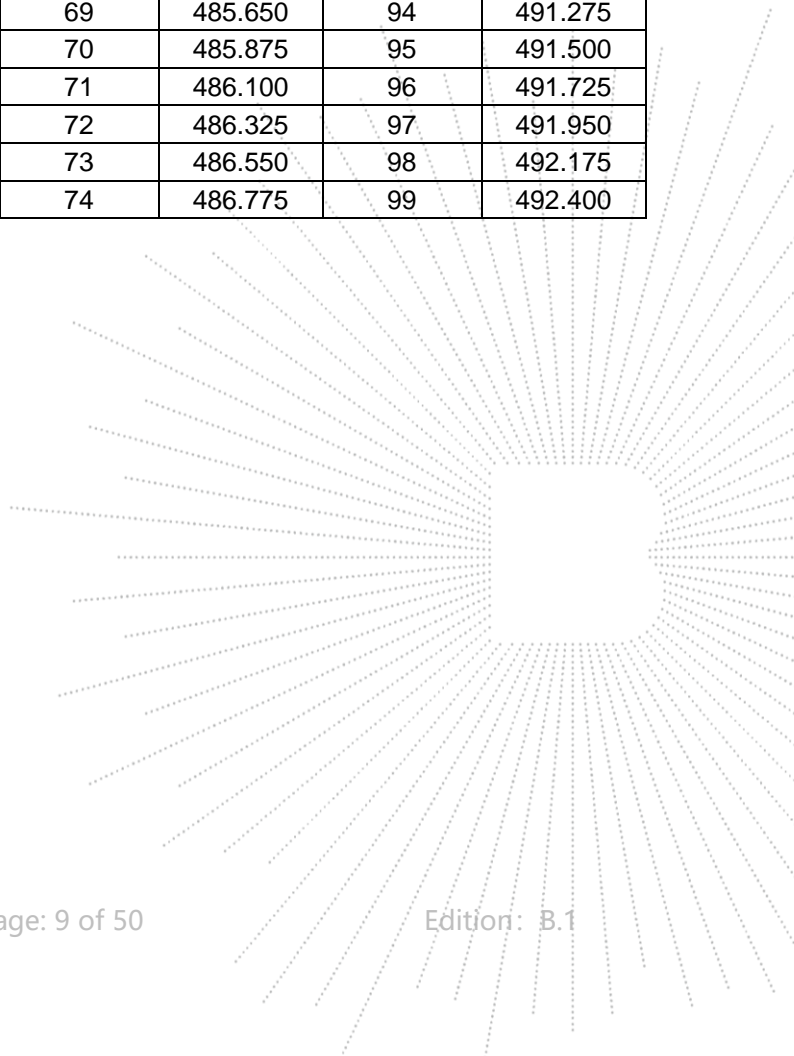

500.125MHz~522.400MHz

Channel No.	Frequency (MHz)	Channel No.	Frequency (MHz)	Channel No.	Frequency (MHz)	Channel No.	Frequency (MHz)
00	500.125	25	505.750	50	511.375	75	517.000
01	500.350	26	505.975	51	511.600	76	517.225
02	500.575	27	506.200	52	511.825	77	517.450
03	500.800	28	506.425	53	512.050	78	517.675
04	501.025	29	506.650	54	512.275	79	517.900
05	501.250	30	506.875	55	512.500	80	518.125
06	501.475	31	507.100	56	512.725	81	518.350
07	501.700	32	507.325	57	512.950	82	518.575
08	501.925	33	507.550	58	513.175	83	518.800
09	502.150	34	507.775	59	513.400	84	519.025
10	502.375	35	508.000	60	513.625	85	519.250
11	502.600	36	508.225	61	513.850	86	519.475
12	502.825	37	508.450	62	514.075	87	519.700
13	503.050	38	508.675	63	514.300	88	519.925
14	503.275	39	508.900	64	514.525	89	520.150
15	503.500	40	509.125	65	514.750	90	520.375
16	503.725	41	509.350	66	514.975	91	520.600
17	503.950	42	509.575	67	515.200	92	520.825
18	504.175	43	509.800	68	515.425	93	521.050
19	504.400	44	510.025	69	515.650	94	521.275
20	504.625	45	510.250	70	515.875	95	521.500
21	504.850	46	510.475	71	516.100	96	521.725
22	505.075	47	510.700	72	516.325	97	521.950
23	505.300	48	510.925	73	516.550	98	522.175
24	505.525	49	511.150	74	516.775	99	522.400

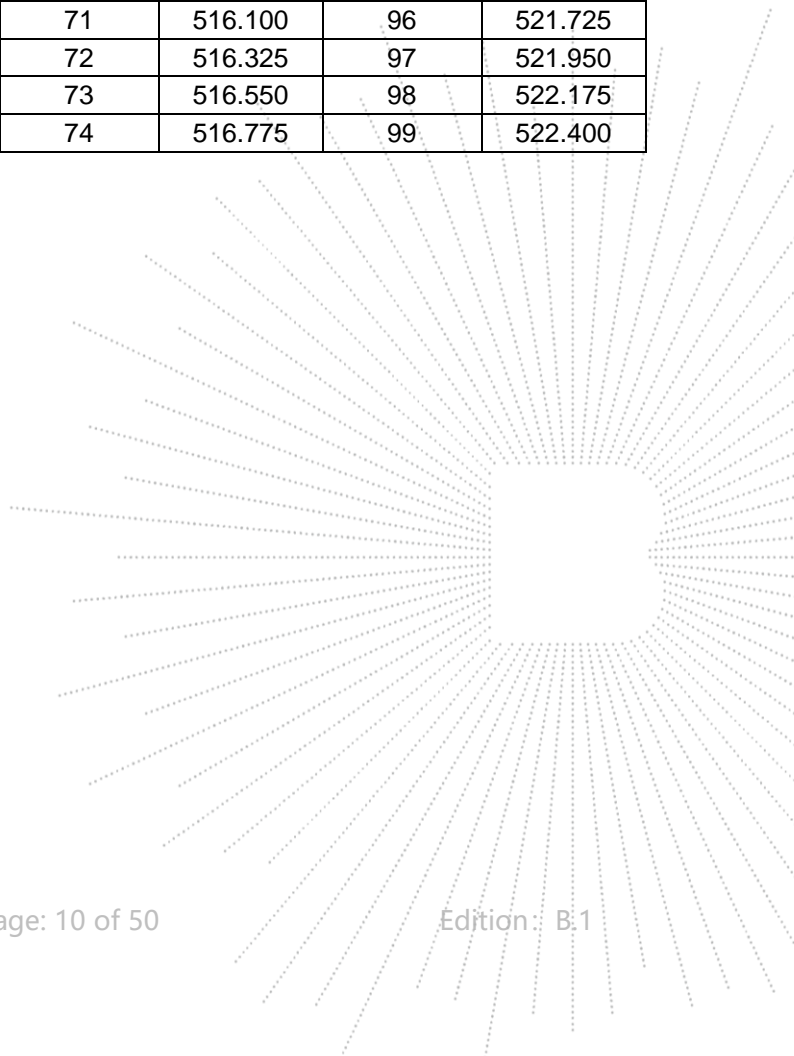

4.5 Test Mode

To investigate the maximum EMI emission characteristics generates from EUT, the test system was pre-scanning tested base on the consideration of following EUT operation mode or test configuration mode which possible have effect on EMI emission level. Each of these EUT operation mode(s) or test configuration mode(s) mentioned above was evaluated respectively.

Test Mode	Description
Mode 1	Transmitting (CH00:470.125MHz)
Mode 2	Transmitting (CH50:481.375MHz)
Mode 3	Transmitting (CH99:492.400MHz)
Mode 4	Transmitting (CH00:500.125MHz)
Mode 5	Transmitting (CH50:511.375MHz)
Mode 6	Transmitting (CH99:522.400MHz)

Note:

The measurements are performed at the available channels.

4.6 Test Conditions

	Normal	LTLV	LTHV	HTHV	HTLV
Temperature (°C)	20	-30	-30	50	50
Voltage (V)	3.7	3.33	4.07	3.33	4.07

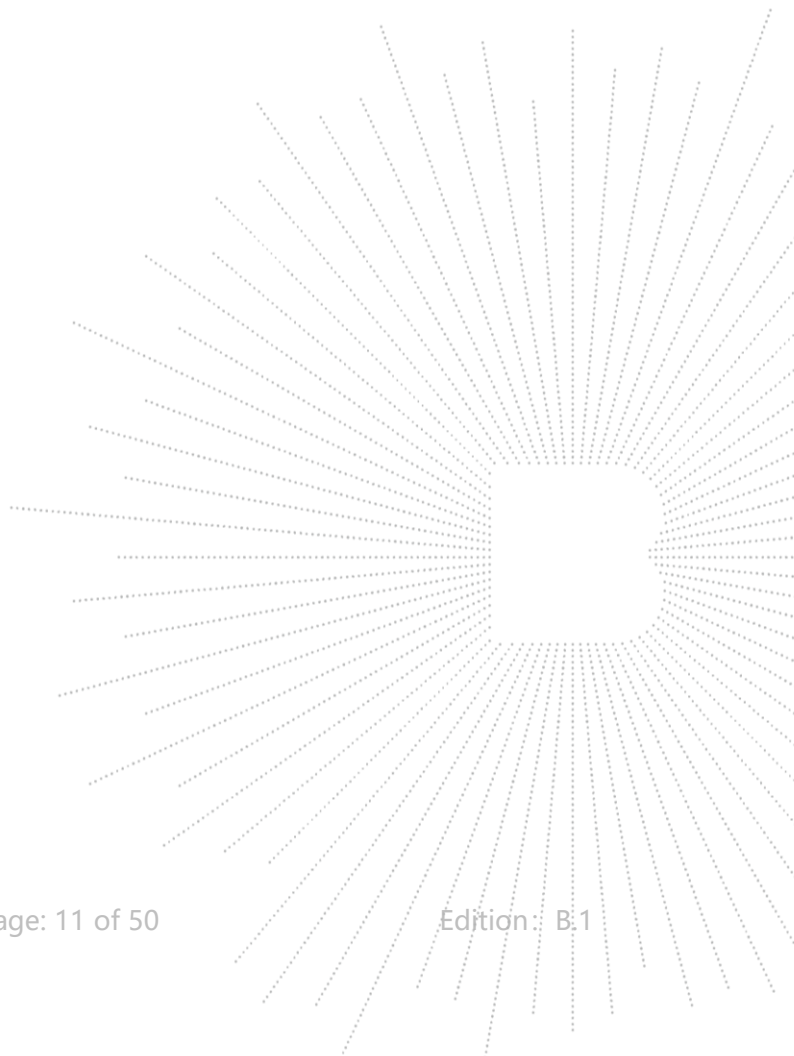

5. Test Facility And Test Instrument Used

5.1 Test Facility

All measurement facilities used to collect the measurement data are located at Shenzhen BCTC Testing Co., Ltd. Address: 1-2/F., Building B, Pengzhou Industrial Park, No.158, Fuyuan 1st Road, Zhancheng, Fuhai Subdistrict, Bao'an District, Shenzhen, Guangdong, China. The site and apparatus are constructed in conformance with the requirements of ANSI C63.4 and CISPR 16-1-1 other equivalent standards.

FCC Test Firm Registration Number: 712850

A2LA certificate registration number is: CN1212

ISED Registered No.: 23583

ISED CAB identifier: CN0017

5.2 Test Instrument Used

RF Conducted Test					
Equipment	Manufacturer	Model#	Serial#	Last Cal.	Next Cal.
Power meter	Keysight	E4419	\	May 15, 2023	May 14, 2024
Power Sensor (AV)	Keysight	E9300A	\	May 15, 2023	May 14, 2024
Signal Analyzer20kHz-26.5GHz	Keysight	N9020A	MY49100060	May 15, 2023	May 14, 2024
Spectrum Analyzer9kHz-40GHz	R&S	FSP40	100363	May 15, 2023	May 14, 2024

Radiated Emissions Test (966 Chamber01)					
Equipment	Manufacturer	Model#	Serial#	Last Cal.	Next Cal.
966 chamber	ChengYu	966 Room	966	May 15, 2023	May 14, 2026
Receiver	R&S	ESR3	102075	May 15, 2023	May 14, 2024
Receiver	R&S	ESRP	101154	May 15, 2023	May 14, 2024
Amplifier	Schwarzbeck	BBV9744	9744-0037	May 15, 2023	May 14, 2024
TRILOG Broadband Antenna	Schwarzbeck	VULB9163	942	May 29, 2023	May 28, 2024
Loop Antenna(9KHz-30MHz)	Schwarzbeck	FMZB1519B	00014	May 31, 2023	May 30, 2024
Amplifier	SKET	LAPA_01G18 G-45dB	SK2021040901	May 15, 2023	May 14, 2024
Horn Antenna	Schwarzbeck	BBHA9120D	1541	May 31, 2023	May 30, 2024
Amplifier(18G Hz-40GHz)	MITEQ	TTA1840-35-HG	2034381	May 15, 2023	May 14, 2024
Horn Antenna(18G Hz-40GHz)	Schwarzbeck	BBHA9170	00822	May 31, 2023	May 30, 2024
Spectrum Analyzer9kHz-40GHz	R&S	FSP40	100363	May 15, 2023	May 14, 2024
Software	Frad	EZ-EMC	FA-03A2 RE	\	\

6. RF Output Power

6.1 Block Diagram Of Test Setup

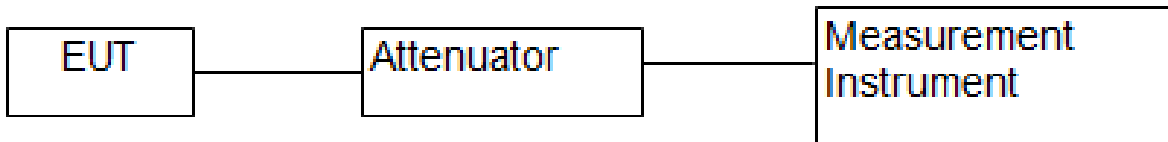

6.2 Limit

According to FCC 74.861(e)(1)(ii)

For low power auxiliary station operating in the 470-608, and 614-698 MHz bands, the power of the measured unmodulated carrier power and the output of the transmitter power amplifier (antenna input power) may not exceed 250mW.

6.3 Test Procedure

1. The maximum peak output power was measured with a Spectrum Analyzer connected to the antenna terminal while EUT was operating in unmodulated situation.
 2. Power was supplied to the battery input connector a power supply. The power supply was set for +3.7VDC. The Spectrum Analyzer was connected at antenna terminal to measure RF power of the carrier.
 3. A Multimeter was connected in series with final RF Stage to measure the current; A Multimeter was used to measure final RF Stage supply voltage. Then the voltage v.s. current of the final RF Stage can be showed.
- Measure and record the results in the test report.

6.4 EUT Operating Conditions

The EUT was configured for testing in a typical fashion (as a customer would normally use it). The EUT has been programmed to continuously transmit during test. This operating condition was tested and used to collect the included data.

6.5 Test Result

Temperature:	26 °C	Relative Humidity:	54%
Pressure:	101KPa	Test Voltage :	DC 3.7V
Test Mode:	470.125MHz~492.400MHz		

Channel	Frequency (MHz)	RF Stage Voltage (Vdc)	Collected Current (mA)	Output Power (dBm)	Limit (dBm)
Low	470.125	3.00	0.35	8.227	24
Middle	481.375	3.00	0.35	7.413	24
High	492.400	3.00	0.35	5.820	24

Low Channel (470.125MHz)

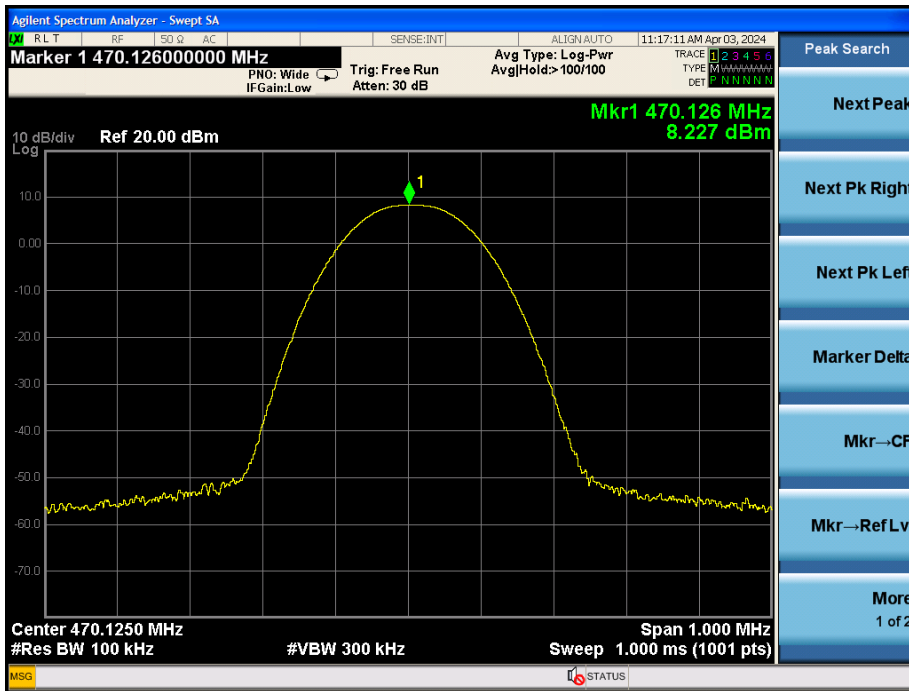

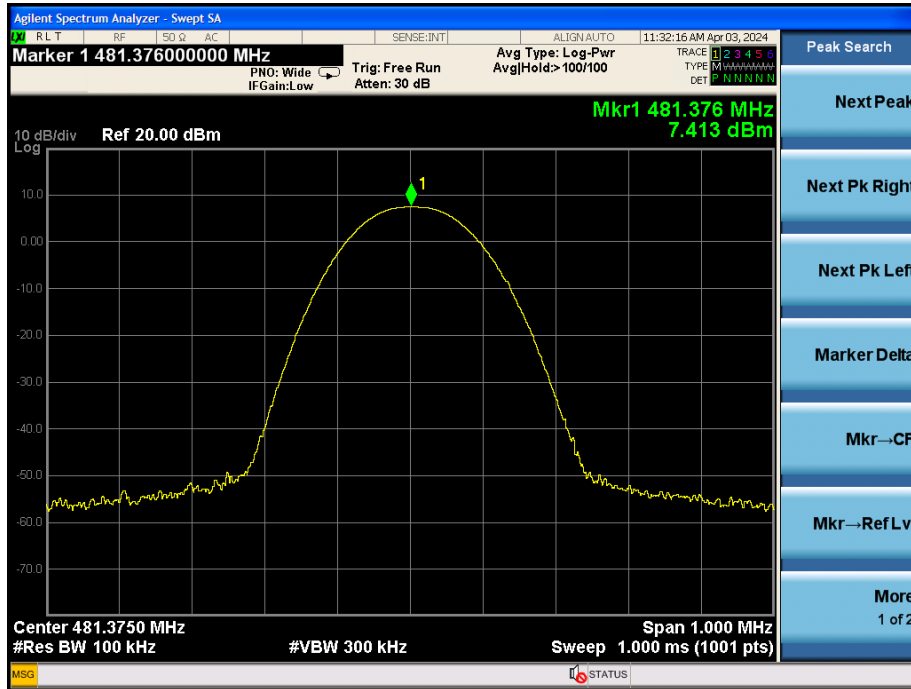
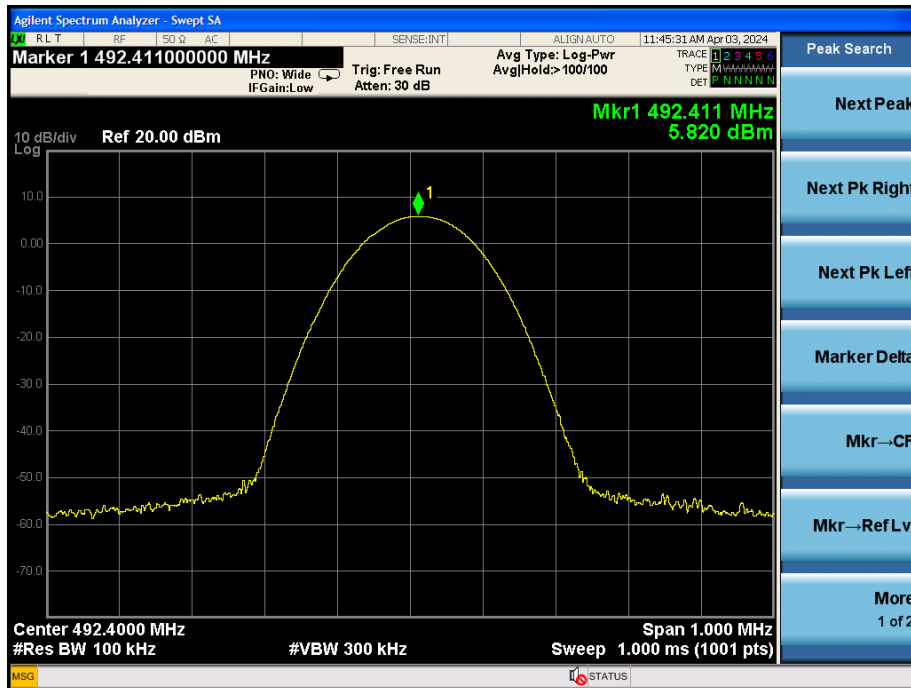
Middle Channel (481.375MHz)

High Channel (492.4MHz)

Temperature:	26 °C	Relative Humidity:	54%
Pressure:	101KPa	Test Voltage :	DC 3.7V
Test Mode:	500.125MHz~522.400MHz		

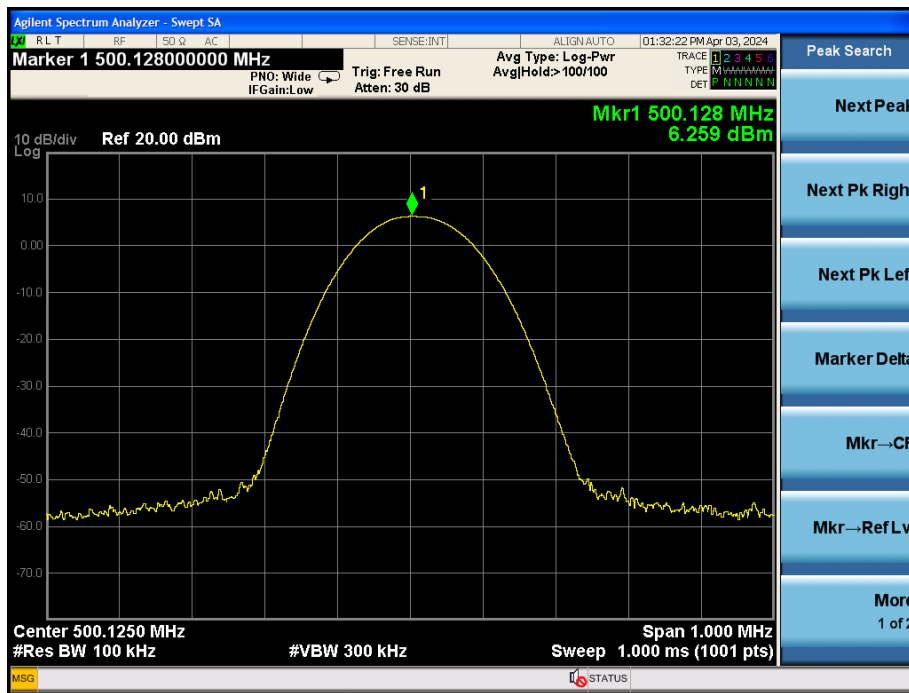
Channel	Frequency (MHz)	RF Stage Voltage (Vdc)	Collected Current (mA)	Output Power (dBm)	Limit (dBm)
Low	500.125	3.00	0.35	6.259	24
Middle	511.375	3.00	0.35	5.974	24
High	522.400	3.00	0.35	4.220	24

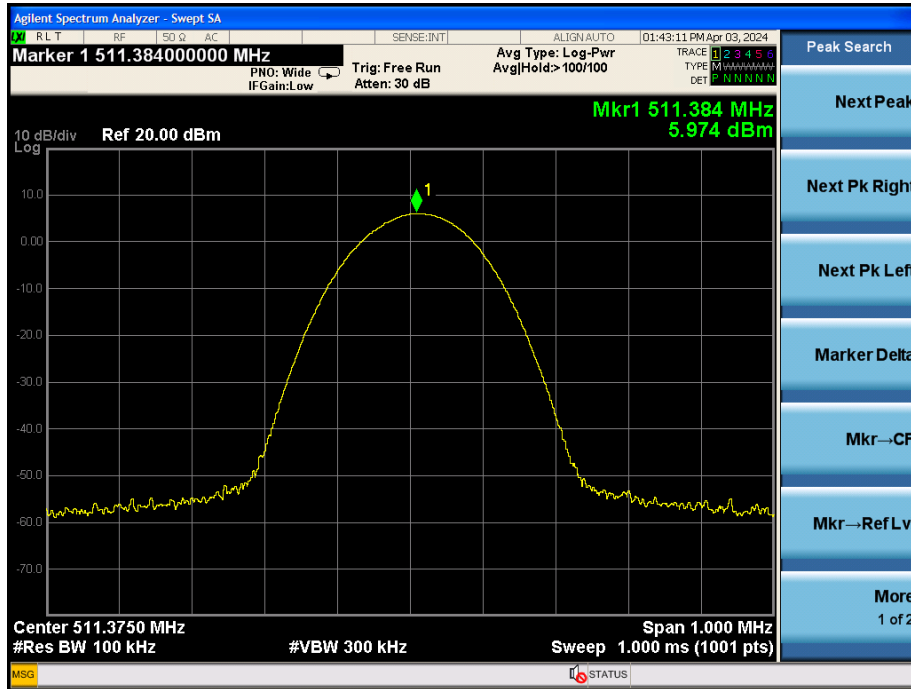
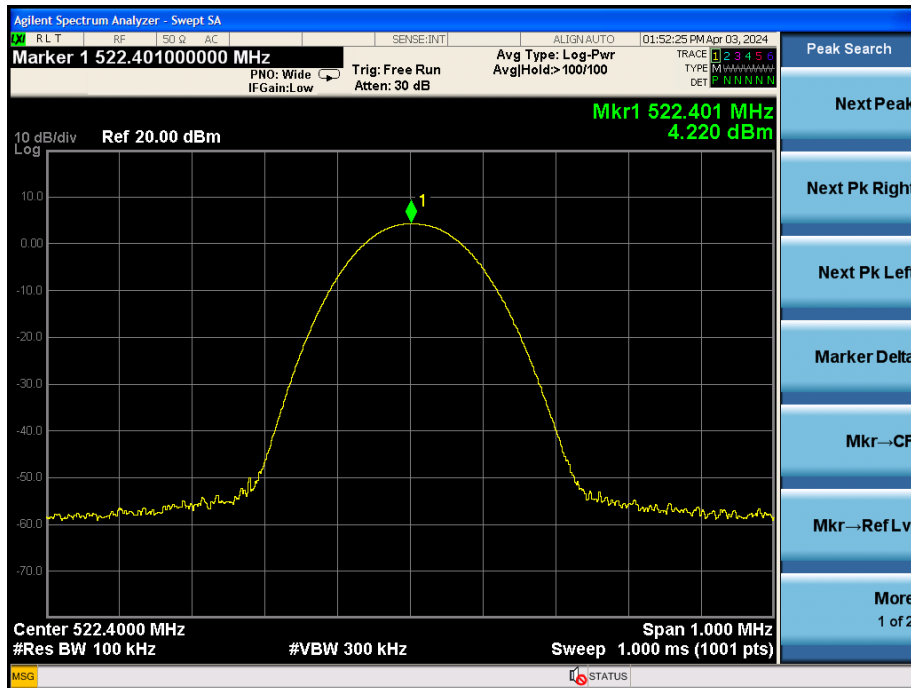
Low Channel (500.125MHz)

Middle Channel (511.375MHz)

High Channel (522.4MHz)

7. Radiated Emissions

7.1 Block Diagram Of Test Setup

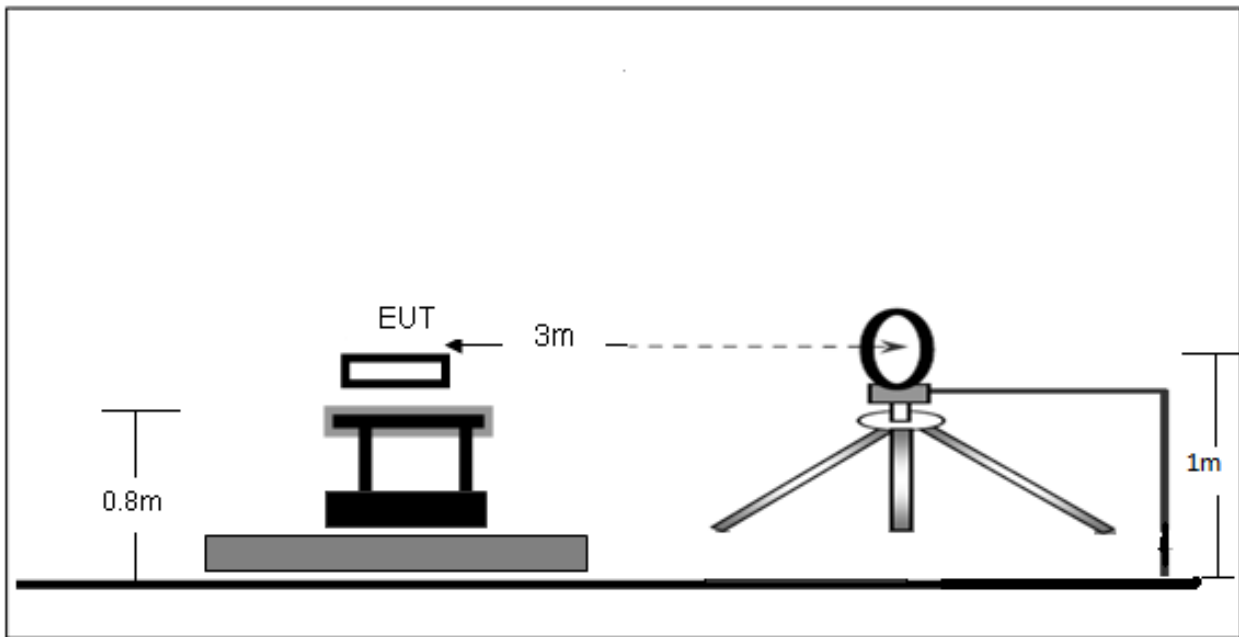
(A) Radiated Emission Test-Up Frequency Below 30MHz



(B) Radiated Emission Test-Up Frequency 30MHz~1GHz

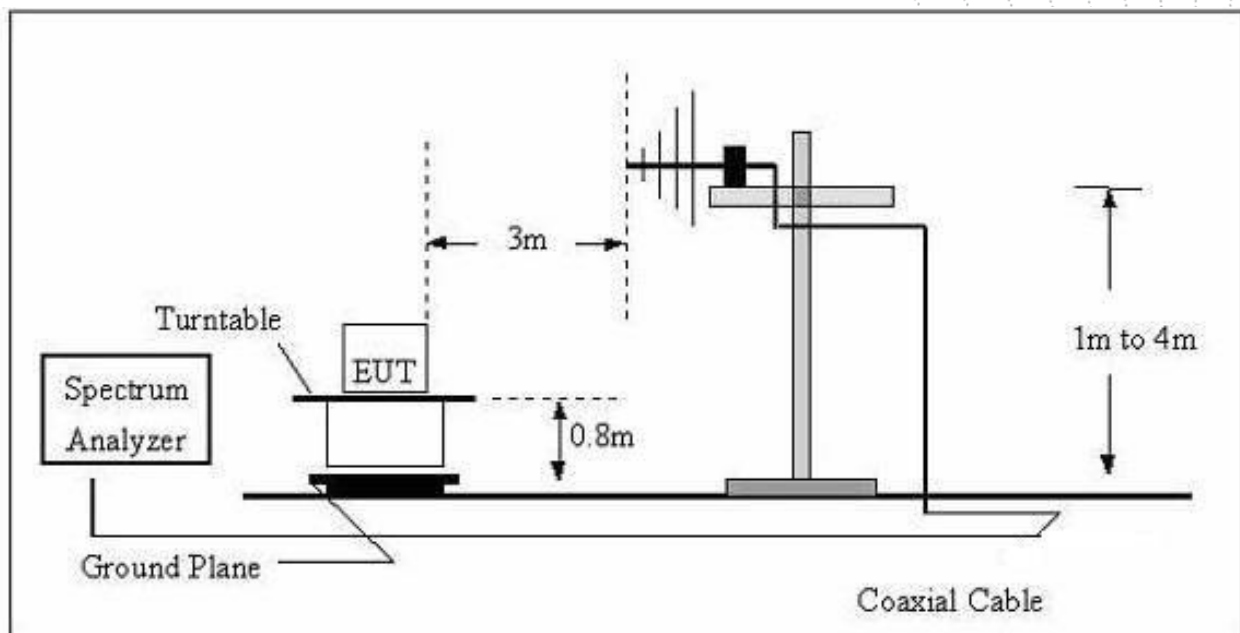

(C) Radiated Emission Test-Up Frequency Above 1GHz

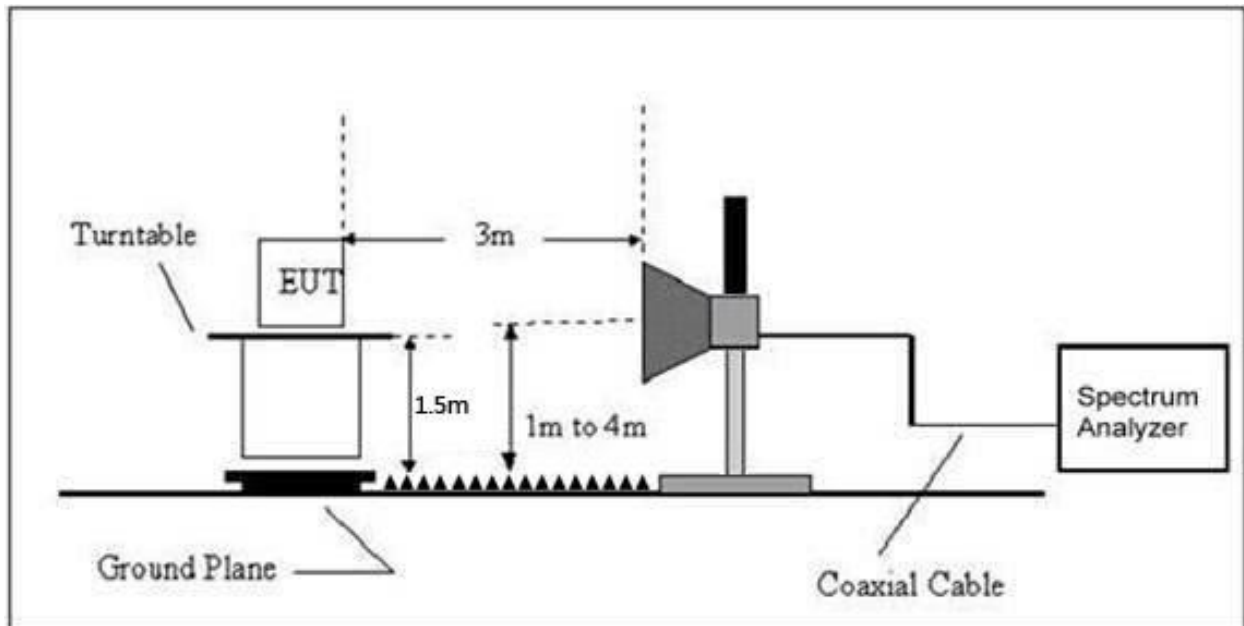

7.2 Limit

According to FCC74.861 (e)(6) and FCC 2.1053

According to FCC 2.1053, measurements shall be made to detect spurious emission that may be radiated directly from the cabinet, control circuits, power leads, or intermediated circuit elements under normal condition of installation and operation. Information submitted shall include the relative radiated power of spurious emission with reference to the rated power output of the transmitter, assuming all emissions are radiated from a halfwave dipole antenna.

According to FCC74.861 (e)(6), the mean power of emissions shall be attenuated below the mean output power of the transmitter in accordance with the following schedule:

1. On any frequency removed from the operating frequency by more than 50 percent up to and including 100 percent of the authorized bandwidth: at least 25 dB.
2. On any frequency removed from the operating frequency by more than 100 percent up to and including 250 percent of the authorized bandwidth: at least 35 dB.
3. On any frequency removed from the operating frequency by more than 250 percent up to and the authorized bandwidth shall be attenuated below the un-modulated carrier by at least 43 plus 10 Log (output power in watts) dB

7.3 Test Procedure

The setup of EUT is according with per TIA/EIA Standard 603 and ANSI C63.4-2014 measurement procedure.

- a) Place the EUT in the center of the turntable. The EUT shall be configured to transmit into the standard non-radiating load (for measuring radiated spurious emissions), connected with cables of minimal length unless specified otherwise. If the EUT uses an adjustable antenna, the antenna shall be positioned to the length that produces the worst case emission at the fundamental operating frequency.
 - b) Each emission under consideration shall be evaluated:
 - 1) Raise and lower the measurement antenna in accordance 5.5.2, as necessary to enable detection of the maximum emission amplitude relative to measurement antenna height.
 - 2) Rotate the EUT through 360° to determine the maximum emission level relative to the axial position.
 - 3) Return the turntable to the azimuth where the highest emission amplitude level was observed.
 - 4) Vary the measurement antenna height again through 1 m to 4 m again to find the height associated with the maximum emission amplitude.
 - 5) Record the measured emission amplitude level and frequency using the appropriate RBW.
 - c) Repeat step b) for each emission frequency with the measurement antenna oriented in both the horizontal and vertical polarizations to determine the orientation that gives the maximum emissions amplitude.
 - d) Set-up the substitution measurement with the reference point of the substitution antenna located as ear as possible to where the center of the EUT radiating element was located during the initial EUT measurement.
 - e) Maintain the previous measurement instrument settings and test set-up, with the exception that the EUT is removed and replaced by the substitution antenna.
 - f) Connect a signal generator to the substitution antenna; locate the signal generator so as to minimize ny potential influences on the measurement results. Set the signal generator to the frequency here emissions are detected, and set an output power level such that the radiated signal can be etected by the measurement instrument, with sufficient dynamic range relative to the noise floor.
 - g) For each emission that was detected and measured in the initial test [i.e., in step b) and step c]):
 - 1) Vary the measurement antenna height between 1 m to 4 m to maximize the received (measured) signal amplitude.
 - 2) Adjust the signal generator output power level until the amplitude detected by the measurement instrument equals the amplitude level of the emission previously measured directly in step b) and step c).
 - 3) Record the output power level of the signal generator when equivalence is achieved in step 2).
 - h) Repeat step e) through step g) with the measurement antenna oriented in the opposite polarization. The measurement antenna was placed at a distance of 3 meters from the EUT. During the tests, the antenna height and polarization as well as EUT azimuth were varied in order to identify the maximum level of emissions from the EUT. The test was performed by placing the EUT on 3-orthogonal axis. The frequency range up to tenth harmonic of the fundamental frequency was investigated. Remove the EUT and replace it with substitution antenna. A signal generator was connected to the substitution antenna by a non-radiating cable. The absolute levels of the spurious emissions were measured by the substitution.
- Spurious attenuation limit in dB = $43 + 10 \text{ Log}_{10} (\text{power in Watts})$

7.4 EUT Operating Conditions

The EUT was configured for testing in a typical fashion (as a customer would normally use it). The EUT has been programmed to continuously transmit during test. This operating condition was tested and used to collect the included data.

7.5 Test Result

Temperature:	26 °C	Relative Humidity:	54%
Pressure:	101KPa	Test Voltage :	DC 3.7V
Test Mode:	470.125MHz~492.400MHz		

Frequency (MHz)	Reading (dBm)	Correct dB	Result (dBm)	Limit (dBm)	Margin (dB)	Polar H/V
Low Channel (470.125MHz)						
77.140	-54.10	-15.91	-70.01	-13.00	-57.01	H
940.250	-14.95	-4.39	-19.34	-13.00	-6.34	H
1410.375	-25.13	-27.90	-53.03	-13.00	-40.03	H
77.140	-59.08	-15.91	-74.99	-13.00	-61.99	V
940.250	-18.83	-4.39	-23.22	-13.00	-10.22	V
1410.375	-30.09	-27.90	-57.99	-13.00	-44.99	V
Middle Channel (481.375MHz)						
77.140	-57.89	-15.91	-73.80	-13.00	-60.80	H
962.750	-21.66	-3.72	-25.38	-13.00	-12.38	H
1444.125	-27.27	-27.82	-55.09	-13.00	-42.09	H
77.140	-61.03	-15.91	-76.94	-13.00	-63.94	V
962.750	-23.71	-3.72	-27.43	-13.00	-14.43	V
1444.125	-30.48	-27.82	-58.30	-13.00	-45.30	V
High Channel (492.400MHz)						
77.140	-56.03	-15.91	-71.94	-13.00	-58.94	H
984.800	-21.03	-3.06	-24.09	-13.00	-11.09	H
1477.200	-28.60	-27.75	-56.35	-13.00	-43.35	H
77.140	-59.77	-15.91	-75.68	-13.00	-62.68	V
984.800	-25.41	-3.06	-28.47	-13.00	-15.47	V
1477.200	-31.74	-27.75	-59.49	-13.00	-46.49	V

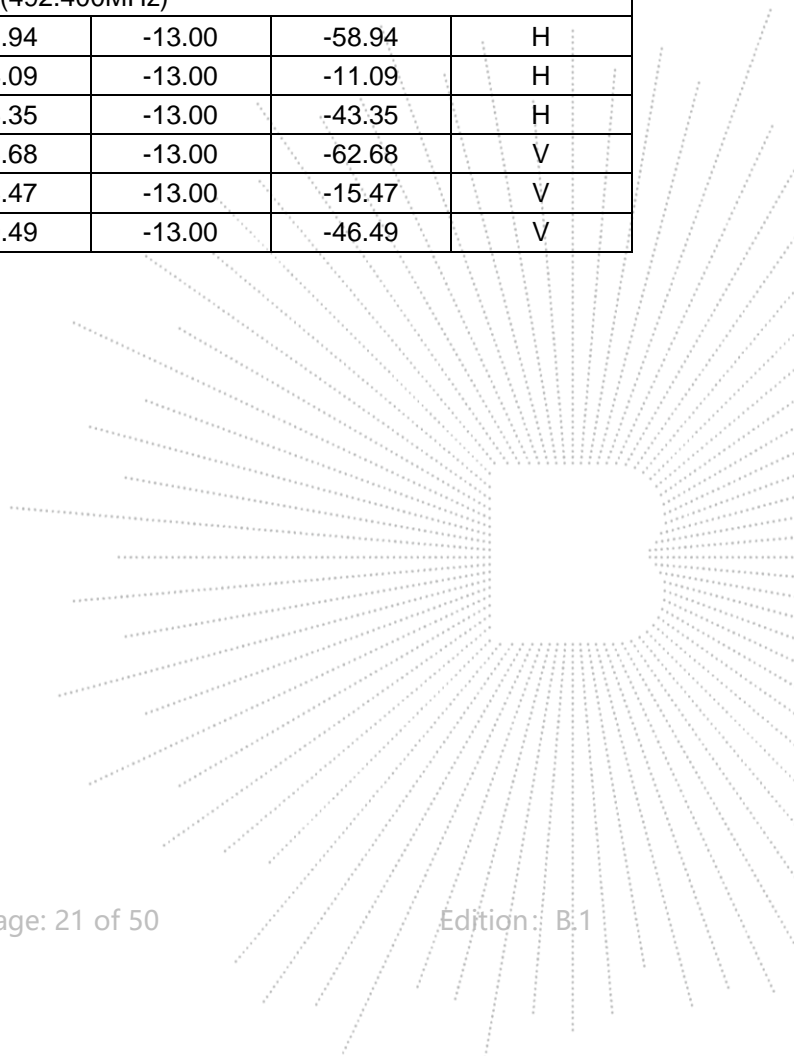

Temperature:	26 °C	Relative Humidity:	54%
Pressure:	101KPa	Test Voltage :	DC 3.7V
Test Mode:	500.125MHz~522.400MHz		

Frequency (MHz)	Reading (dBm)	Correct dB	Result (dBm)	Limit (dBm)	Margin (dB)	Polar H/V
Low Channel (500.125MHz)						
77.140	-56.33	-15.91	-72.24	-13.00	-59.24	H
1000.250	-18.87	-28.80	-47.67	-13.00	-34.67	H
1500.375	-26.35	-27.70	-54.05	-13.00	-41.05	H
77.140	-59.57	-15.91	-75.48	-13.00	-62.48	V
1000.250	-21.13	-28.80	-49.93	-13.00	-36.93	V
1500.375	-28.77	-27.70	-56.47	-13.00	-43.47	V
Middle Channel (511.375MHz)						
83.860	-56.81	-15.91	-72.72	-13.00	-59.72	H
1022.750	-17.39	-28.75	-46.14	-13.00	-33.14	H
1534.125	-28.18	-27.62	-55.80	-13.00	-42.80	H
83.860	-59.61	-15.91	-75.52	-13.00	-62.52	V
1022.750	-20.99	-28.75	-49.74	-13.00	-36.74	V
1534.125	-29.84	-27.62	-57.46	-13.00	-44.46	V
High Channel (522.400MHz)						
83.860	-57.84	-15.91	-73.75	-13.00	-60.75	H
1044.800	-16.48	-28.70	-45.18	-13.00	-32.18	H
1567.200	-22.90	-27.55	-50.45	-13.00	-37.45	H
83.860	-59.55	-15.91	-75.46	-13.00	-62.46	V
1044.800	-18.99	-28.70	-47.69	-13.00	-34.69	V
1567.200	-25.70	-27.55	-53.25	-13.00	-40.25	V

8. Modulation Characteristics

8.1 Block Diagram Of Test Setup

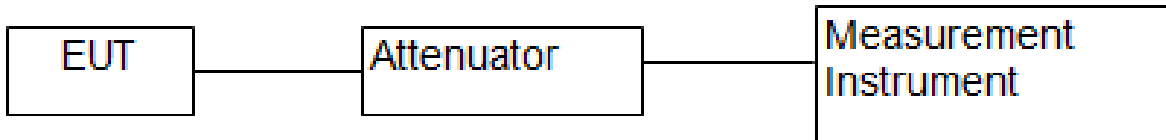

8.2 Limit

According to FCC Part 74.861(e)(3) and 2.1047 (a)

For Voice Modulated Communication Equipment, the frequency response of the audio modulating circuit over a range of 100Hz to 5000Hz shall be measured. For equipment required to have an audio low-pass filter, the frequency response of the filter or of all circuitry installed between the modulation limiter and the modulated stage shall be measured.

Any form of modulation may be used. A maximum deviation of 75 kHz is permitted when frequency modulation is employed.

8.3 Test Procedure

1 Position the EUT as shown in figure 1, adjust the audio input frequency to 100 Hz and the input level from 0V to maximum permitted input voltage with recording each carrier frequency deviation responding to respective input level.

2 Repeat step 1 with changing the input frequency for 100, 300, 1000, 2500 and 3000 Hz in sequence.

8.4 EUT operating Conditions

The EUT tested system was configured as the statements of 2.4 Unless otherwise a special operating condition is specified in the follows during the testing.

8.5 Test Result

Temperature:	26 °C	Relative Humidity:	54%
Pressure:	101KPa	Test Voltage :	DC 3.7V
Test Mode:	470.125MHz~492.400MHz		

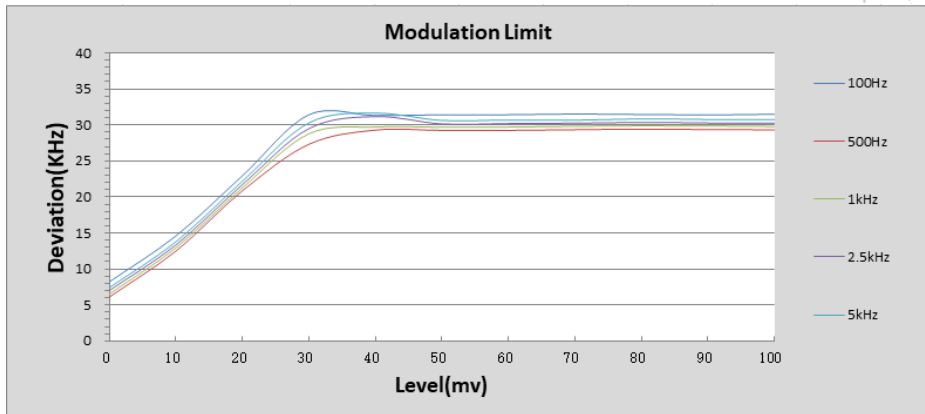
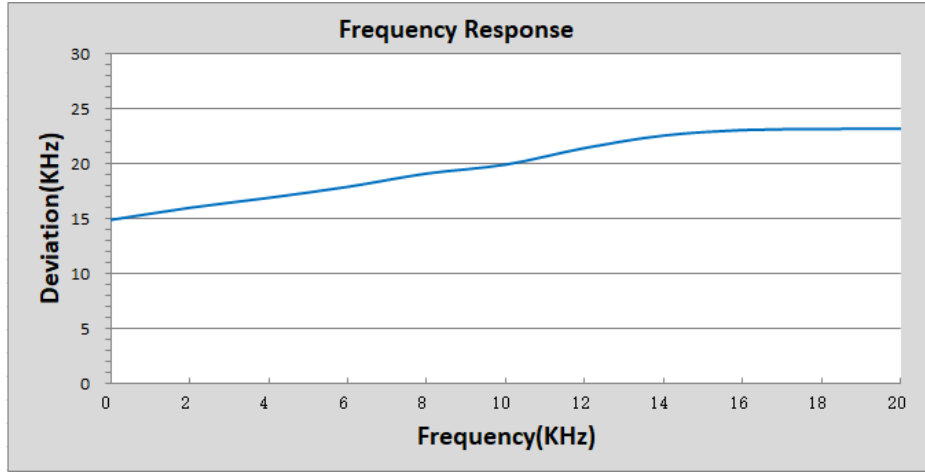
Middle Channel (481.375MHz)

Temperature:	26 °C	Relative Humidity:	54%
Pressure:	101KPa	Test Voltage :	DC 3.7V
Test Mode:	500.125MHz~522.400MHz		

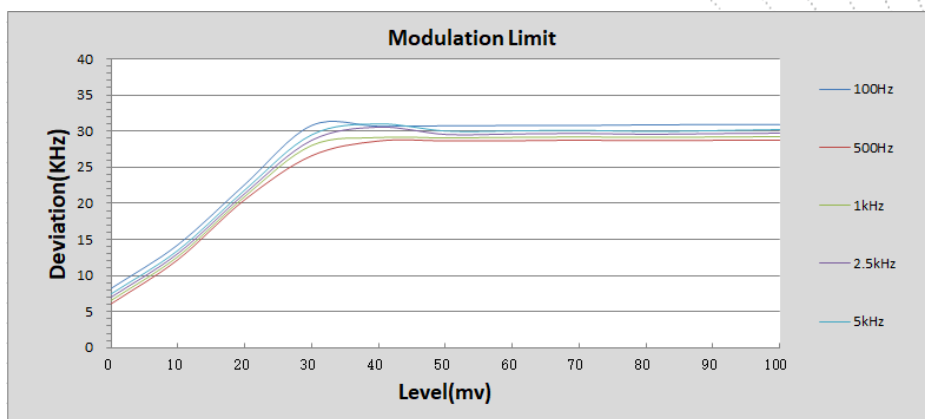
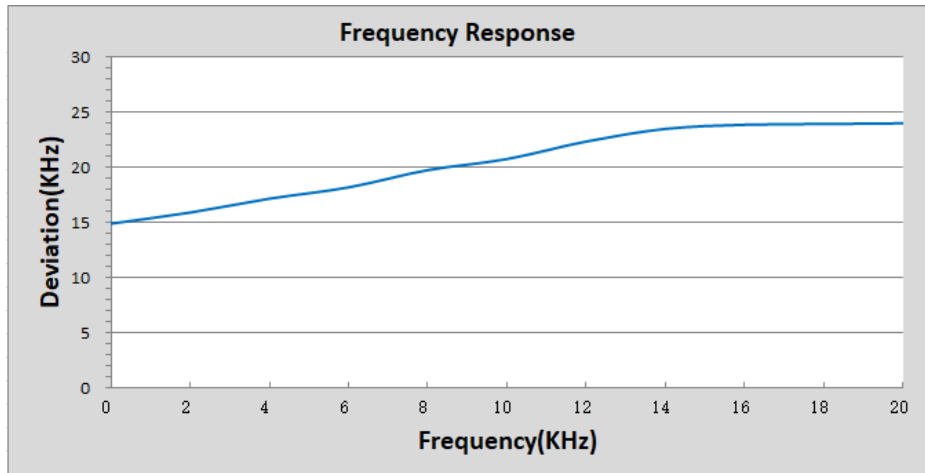
Middle Channel (511.375MHz)

9. Occupied Bandwidth

9.1 Block Diagram Of Test Setup

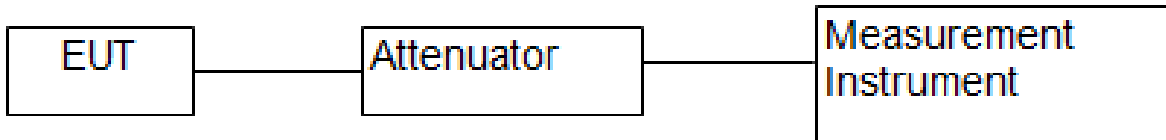

9.2 Limit

According to 74.861(e)(5), 74.861(e)(7) and FCC 2.1049 (c) (1)

According to FCC 2.1049 (c) (1), for radiotelephone transmitter, other than single sideband or independent sideband transmitter, when modulated by a 2.5 kHz tone at an input level 16 dB greater than that necessary to produce 50 percent modulation.

According to §74.861(e)(5), the operating bandwidth shall not exceed 200 kHz.

According to FCC 74.861(e)(6), the mean power of emissions shall be attenuated below the mean output power of the transmitter in accordance with the following schedule:

1 On any frequency removed from the operating frequency by more than 50 percent up to and including 100 percent of the authorized bandwidth: at least 25 dB.

2 On any frequency removed from the operating frequency by more than 100 percent up to and including 250 percent of the authorized bandwidth: at least 35 dB.

3 On any frequency removed from the operating frequency by more than 250 percent up to and the authorized bandwidth shall be attenuated below the un-modulated carrier by at least 43 plus 10 Log (output power in watts) dB.

According to §74.861(e)(7), analog emissions within the band from one megahertz below to one megahertz above the carrier frequency shall comply with the emission mask in section 8.3.1.2 of the European Telecommunications Institute Standard ETSI EN 300 422-1 v1.4.2 (2011-08), Electromagnetic compatibility and Radio spectrum Matters (ERM); Wireless microphones in the 25 MHz to 3 GHz frequency range; part 1: Technical characteristics and methods of measurement. Digital emissions within the band from one megahertz below to one megahertz above the carrier frequency shall comply with the emission mask in section 8.3.2.2 (Figure 4) of the European Telecommunications Institute Standard ETSI EN 300 422-1 v1.4.2 (2011-08), Electromagnetic compatibility and Radio spectrum Matters (ERM); Wireless microphones in the 25 MHz to 3 GHz frequency range; part 1: Technical characteristics and methods of measurement.

9.3 Test Procedure

According to TIA-603 for additional Test Set-Up procedures, the occupied bandwidth of emission was measured with a Spectrum Analyzer connected to the antenna terminal while EUT was operating in 2.5kHz tone at an input level 16 dB greater than that necessary to produce 50 percent modulation. Then mark the -26dB Bandwidth and record it.

9.4 EUT Operating Conditions

The EUT tested system was configured as the statements of 2.4 unless otherwise a special operating condition is specified in the follows during the testing.

9.5 Test Result

Temperature:	26 °C	Relative Humidity:	54%
Pressure:	101KPa	Test Voltage :	DC 3.7V
Test Mode:	470.125MHz~492.400MHz		

Test Channel	Frequency (MHz)	-26dB Bandwidth (kHz)	99% Bandwidth (kHz)	Limit (kHz)
Low	470.125	86.60	71.855	200
Middle	481.375	86.61	74.523	200
High	492.400	85.39	74.114	200

Low Channel (470.125MHz)



Middle Channel (481.375MHz)

High Channel (492.4MHz)

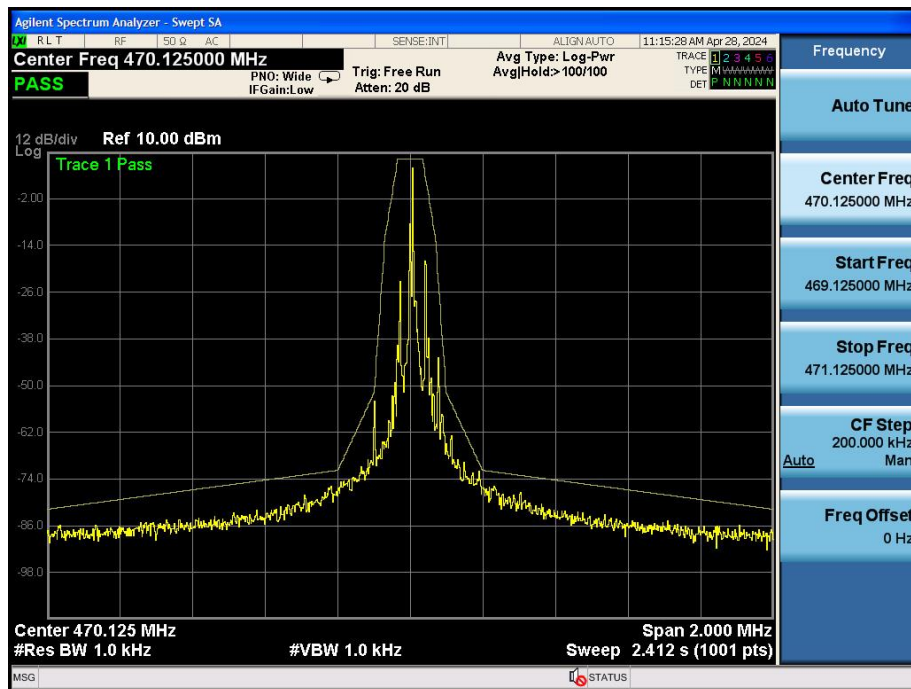
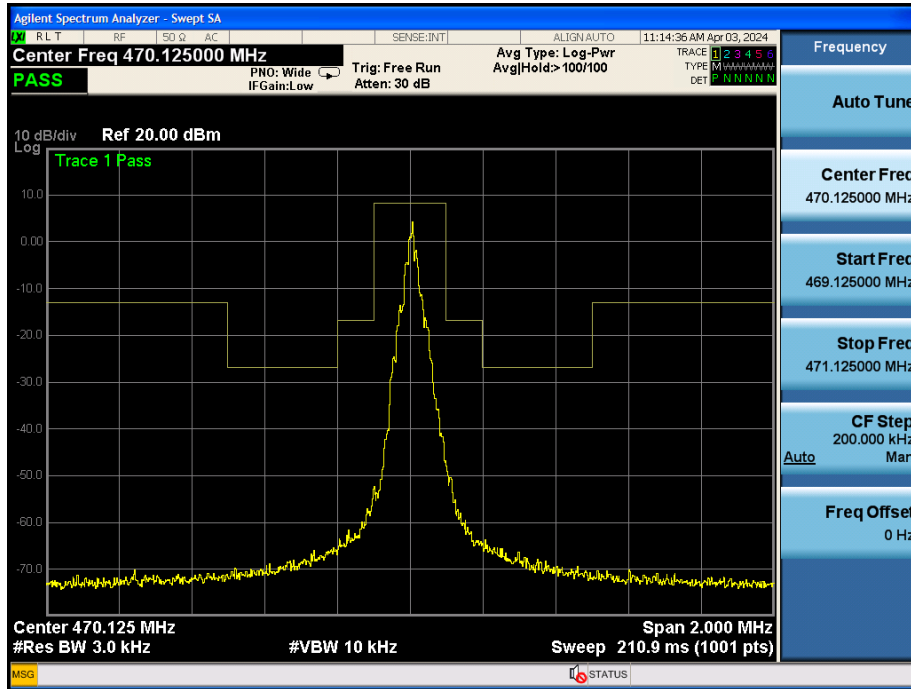

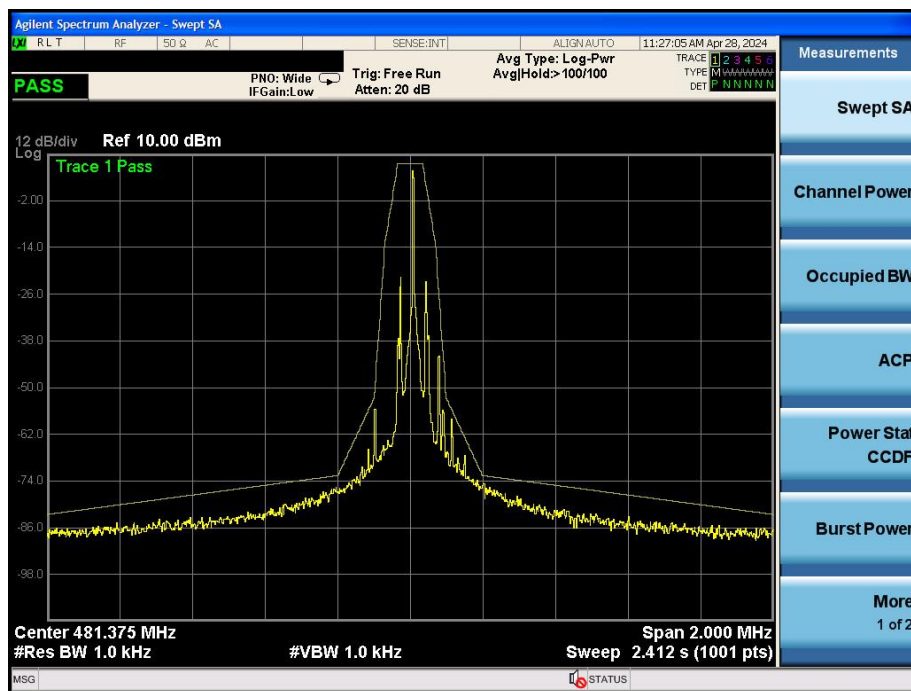
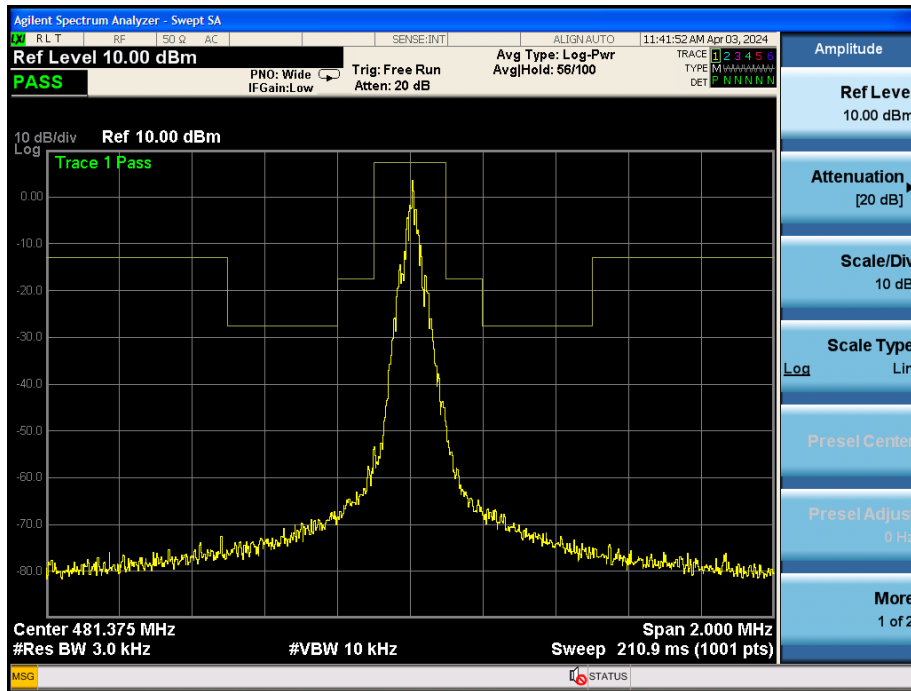
Emission Mask (470.125MHz)

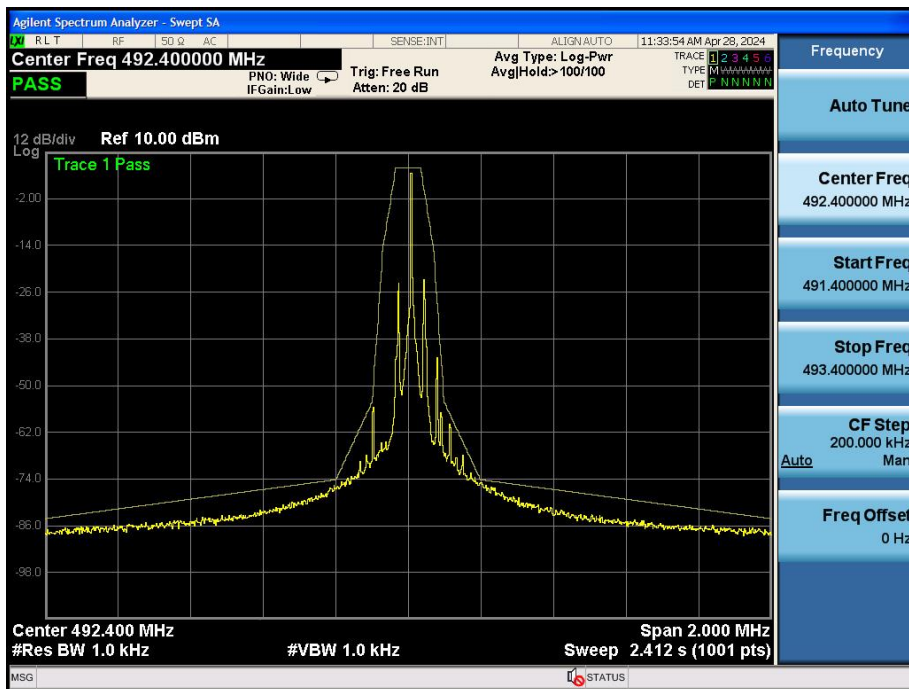
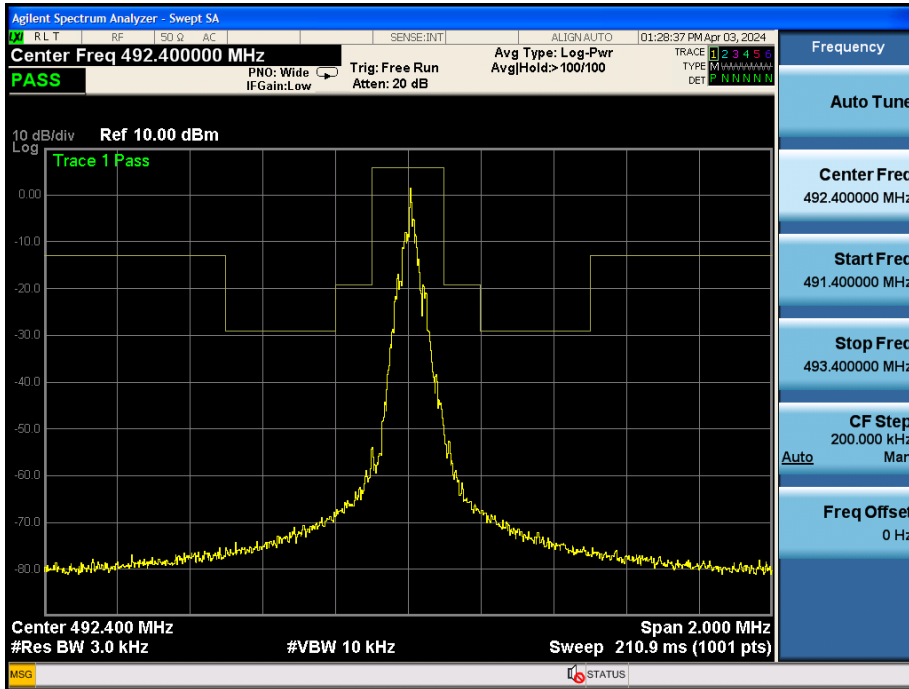
Emission Mask (481.375MHz)

Emission Mask (492.4MHz)

Temperature:	26 °C	Relative Humidity:	54%
Pressure:	101KPa	Test Voltage :	DC 3.7V
Test Mode:	500.125MHz~522.400MHz		

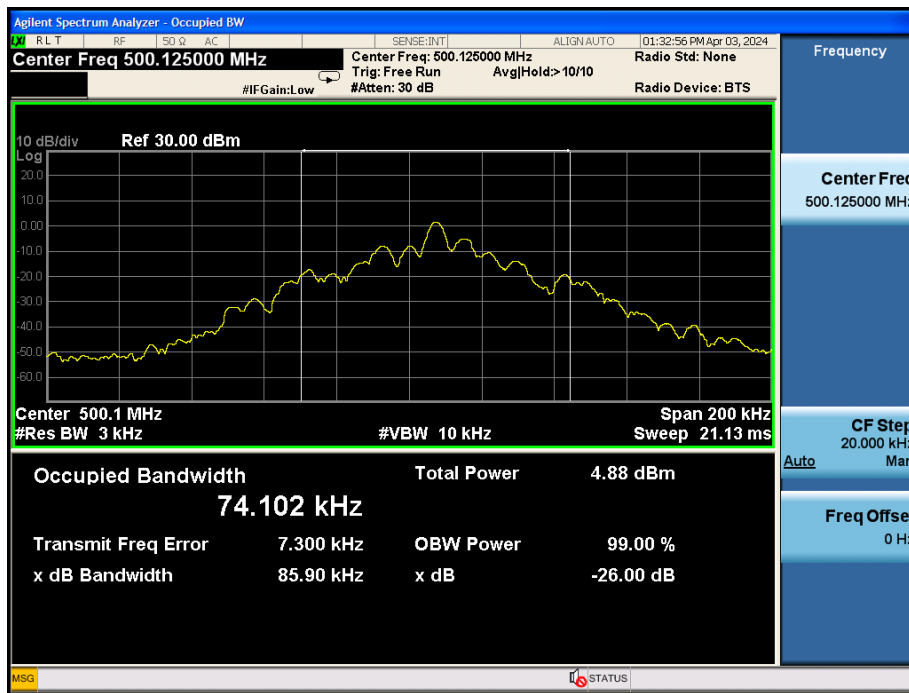
Test Channel	Frequency (MHz)	-26dB Bandwidth (kHz)	99% Bandwidth (kHz)	Limit (kHz)
Low	500.125	85.90	74.102	200
Middle	511.375	85.47	70.788	200
High	522.400	83.66	61.846	200

Low Channel (500.125MHz)

Middle Channel (511.375MHz)

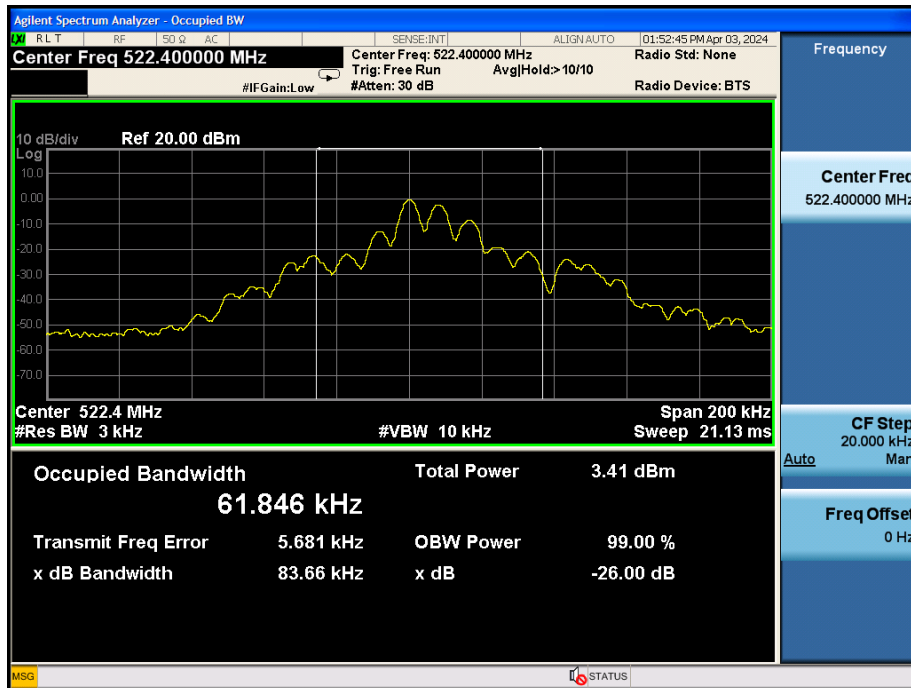
High Channel (522.4MHz)

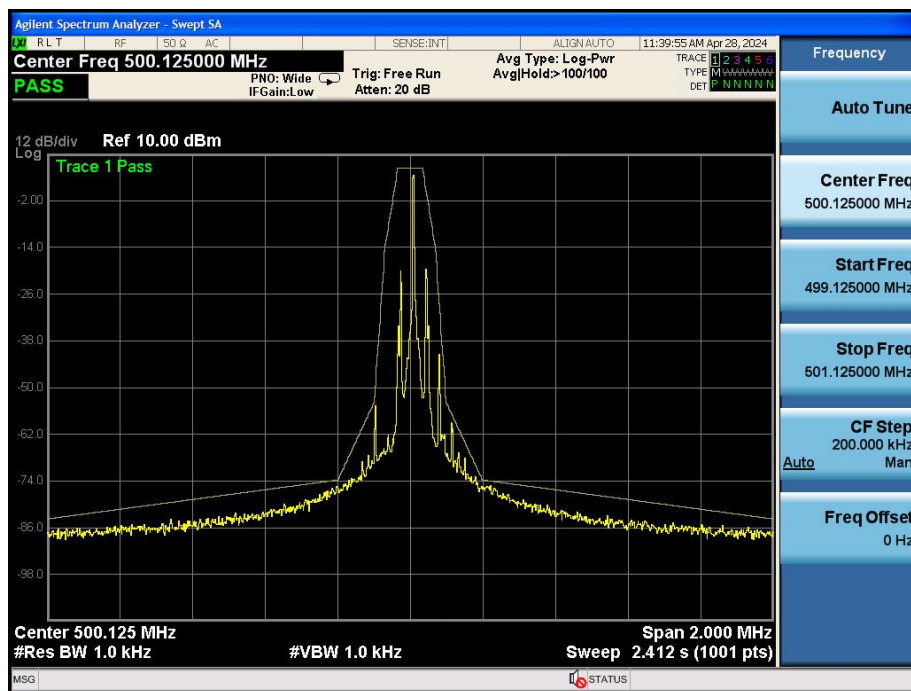
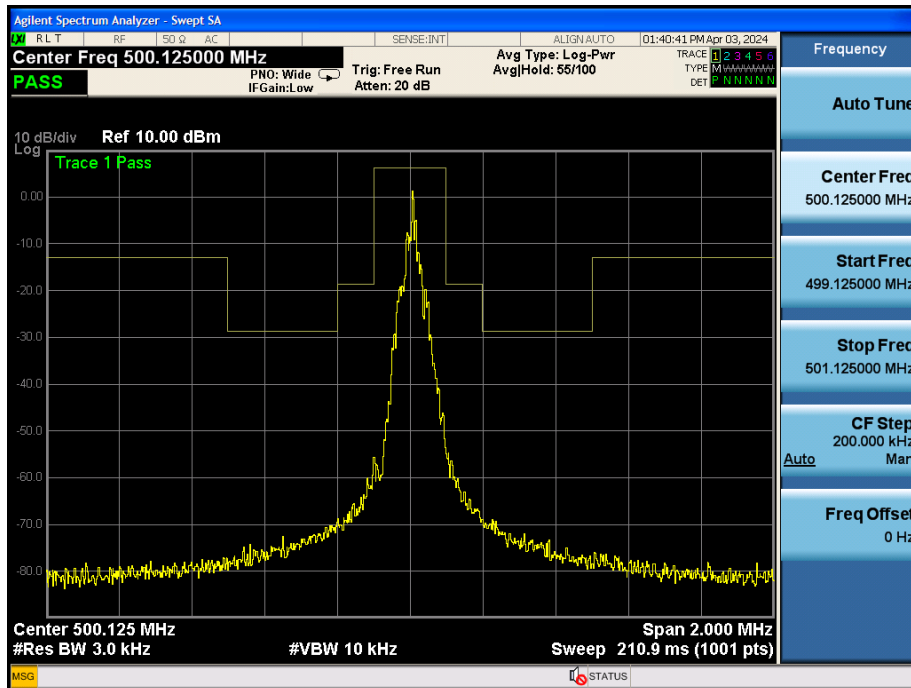
Emission Mask (500.125MHz)

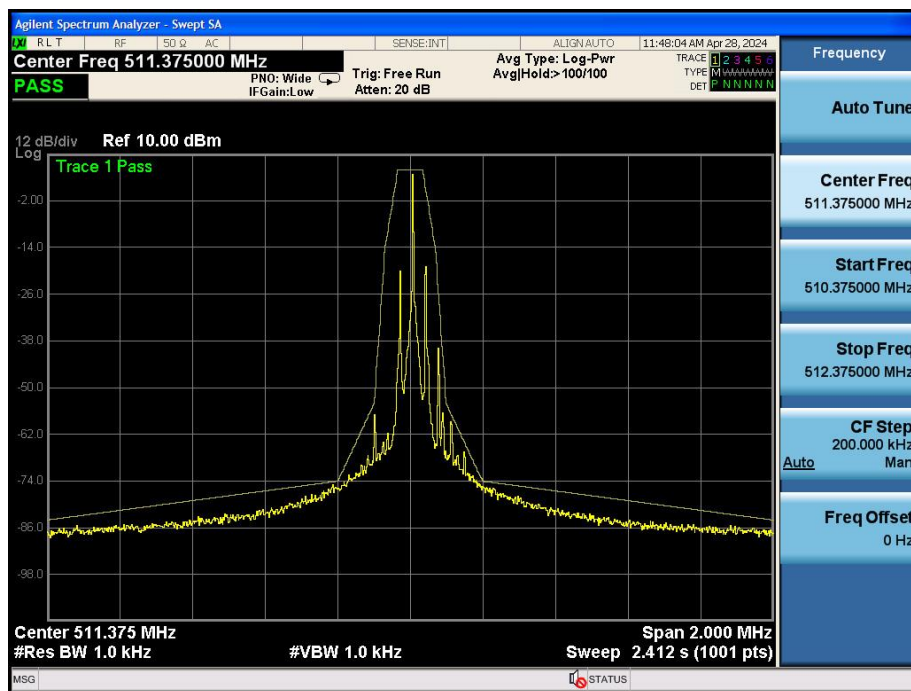
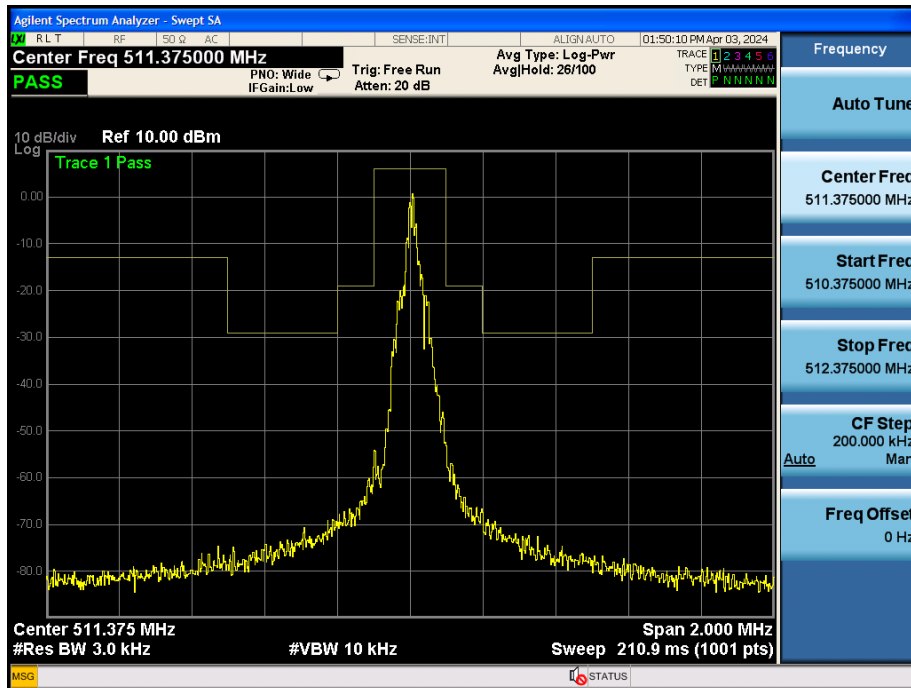
Emission Mask (511.375MHz)

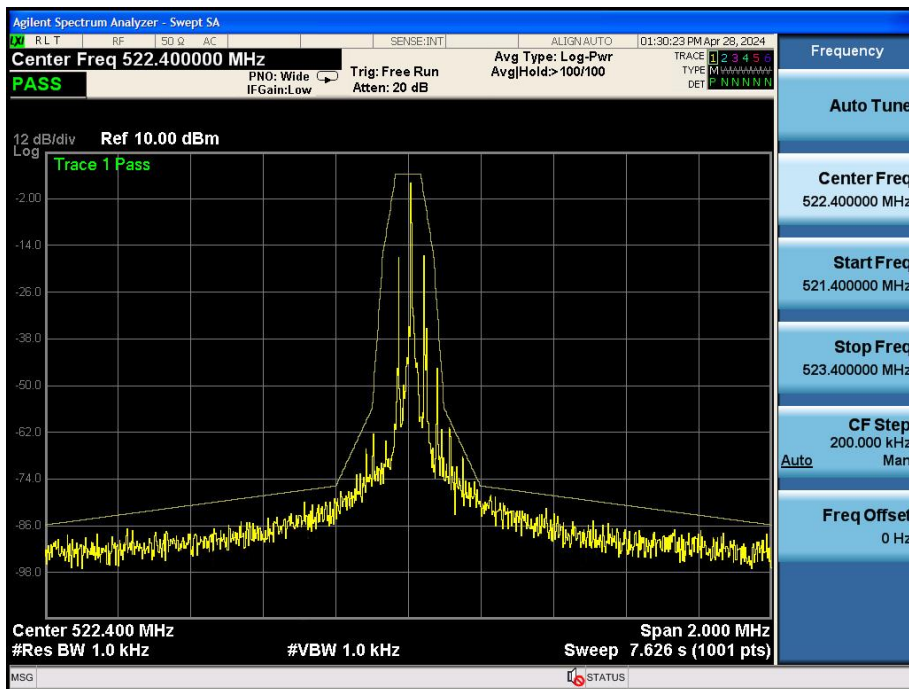
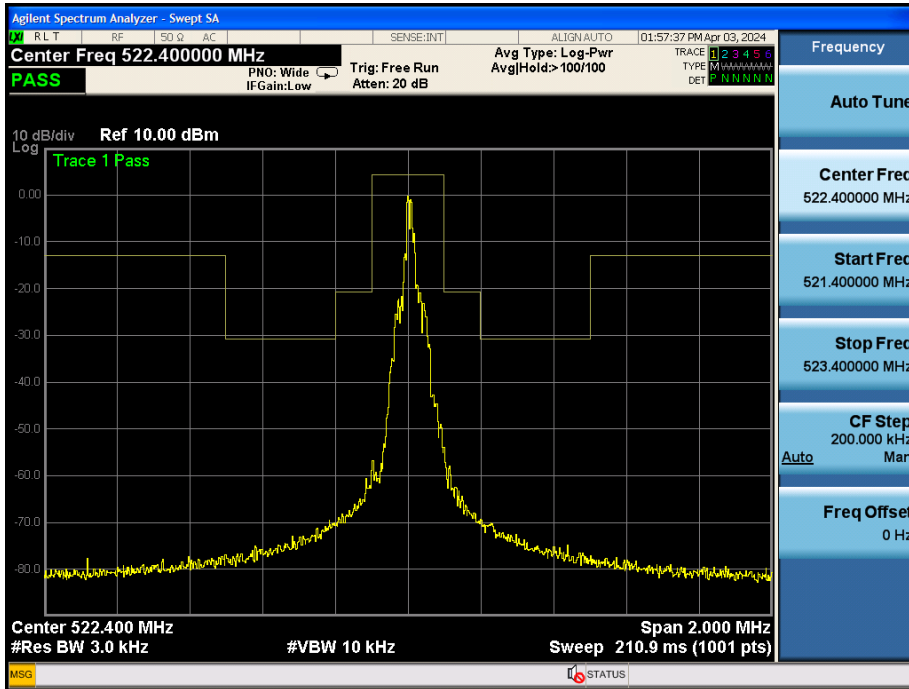
Emission Mask (522.4MHz)

10. Spurious Emission At Antenna Terminal

10.1 Block Diagram Of Test Setup

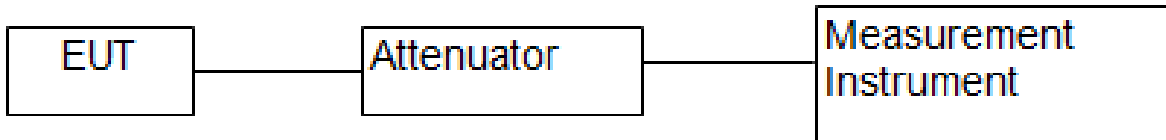

10.2 Limit

According to FCC74.861 (e)(6)

According to §2.1051, the radio frequency voltage or powers generated within the equipment and appearing on a spurious frequency shall be checked at the equipment output terminals when properly loaded with a suitable artificial antenna. Curves or equivalent data shall show the magnitude of each harmonic and other spurious emission that can be detected when the equipment is operated under the conditions specified in §2.1049 as appropriate.

According to FCC74.861 (e)(6), the mean power of emissions shall be attenuated below the mean output power of the transmitter in accordance with the following schedule:

On any frequency removed from the operating frequency by more than 250 percent up to and the authorized bandwidth shall be attenuated below the un-modulated carrier by at least 43 plus 10 Log (output power in watts) dB.

10.3 Test Procedure

The transmitter output (antenna port) was connected to the spectrum analyzer

Reference level measurement

Establish a reference level by using the following procedure:

Set instrument center frequency to EUT center frequency.

Set Span = approximately 5 times the 20 dB bandwidth, centered on a hopping channel.

Set the RBW = 100 kHz. Set the VBW $\geq 3 \times$ RBW.

Set Detector = peak. Set Sweep time = auto couple.

Set Trace mode = max hold. Allow trace to fully stabilize.

Use the peak marker function to determine the maximum Maximum conducted level.

Note that the channel found to contain the maximum conducted level can be used to establish the reference level.

Conducted Spurious RF Conducted Emission

Use the following spectrum analyzer settings:

Span = wide enough to capture the peak level of the in-band emission and all spurious emissions (e.g., harmonics) from the lowest frequency generated in the EUT up through the 10th harmonic. (30MHz to 25GHz).

Set RBW = 100 kHz (above 1GHz Set RBW = 1 MHz) Set VBW RBW

Set Sweep = auto Set Detector function = peak Set Trace = max hold

Allow the trace to stabilize. Set the marker on the peak of any spurious emission recorded. The level displayed must comply with the limit specified in this Section.

10.4 EUT Operating Conditions

The EUT tested system was configured as the statements of 2.4 unless otherwise a special operating condition is specified in the follows during the testing.

10.5 Test Result

Temperature:	26 °C	Relative Humidity:	54%
Pressure:	101KPa	Test Voltage :	DC 3.7V
Test Mode:	500.125MHz~522.400MHz		

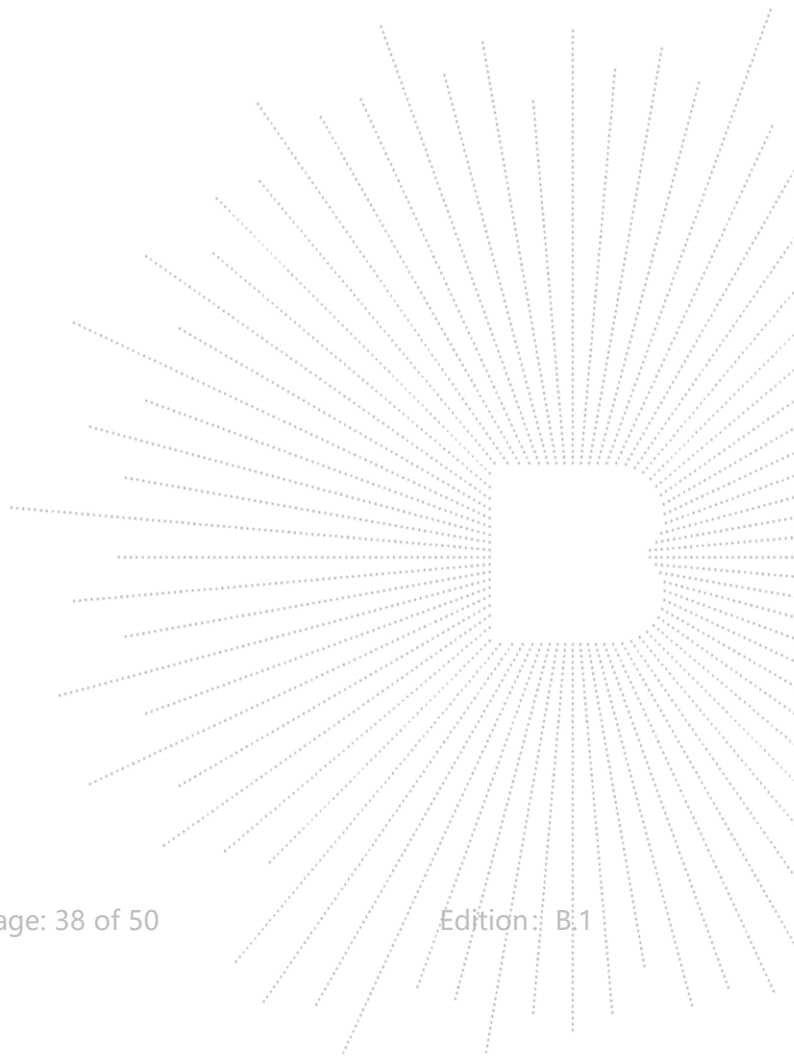

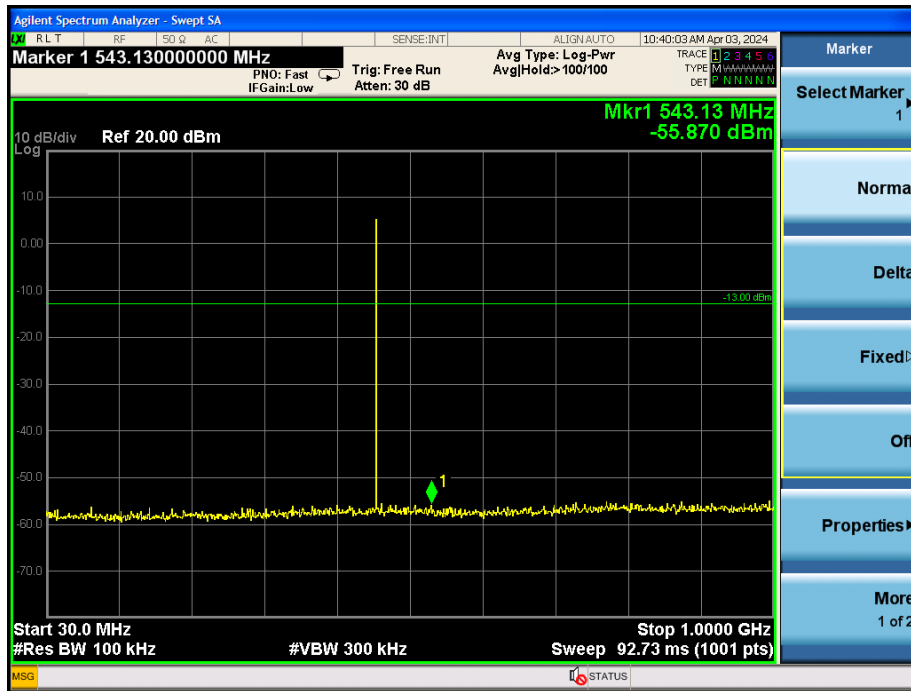
Low Channel(470.125MHz)

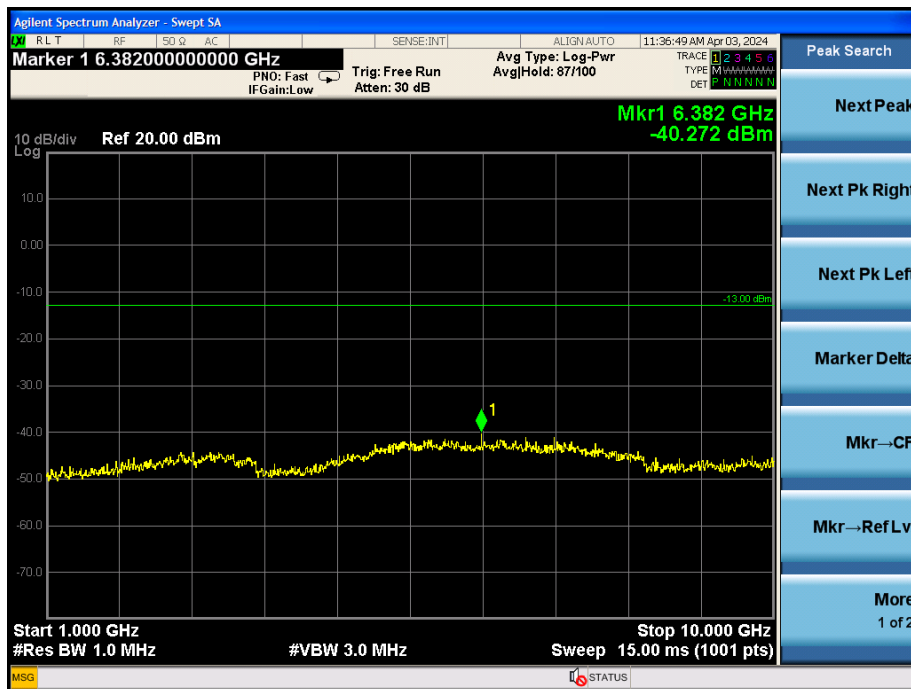
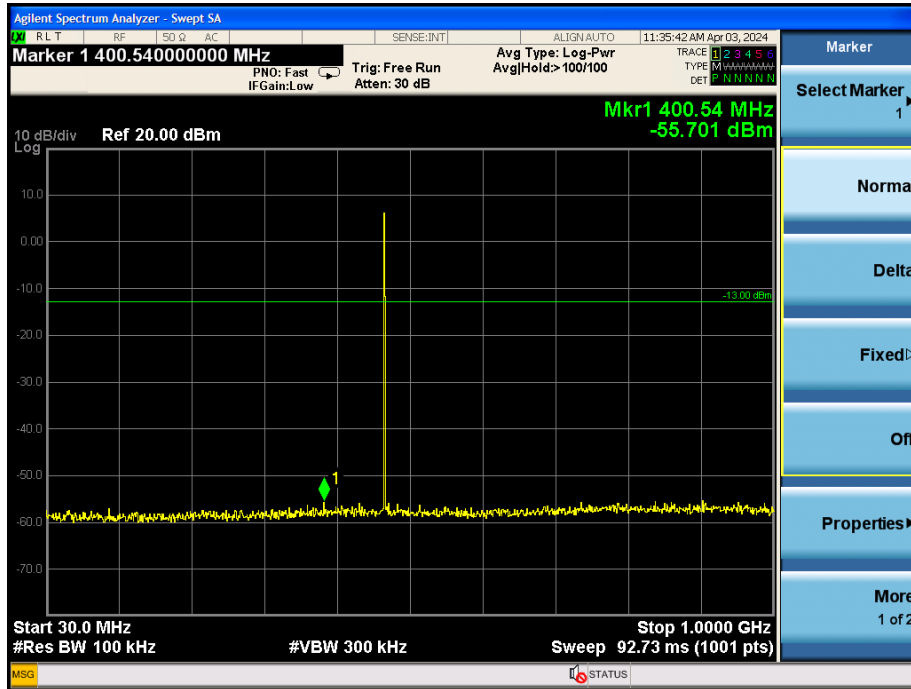
Middle Channel(481.375MHz)

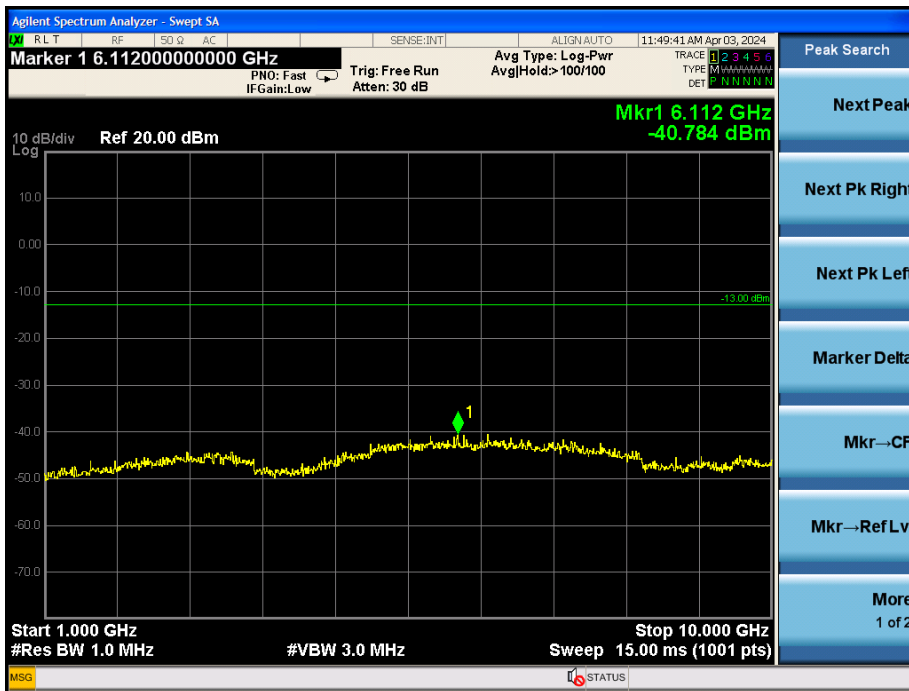
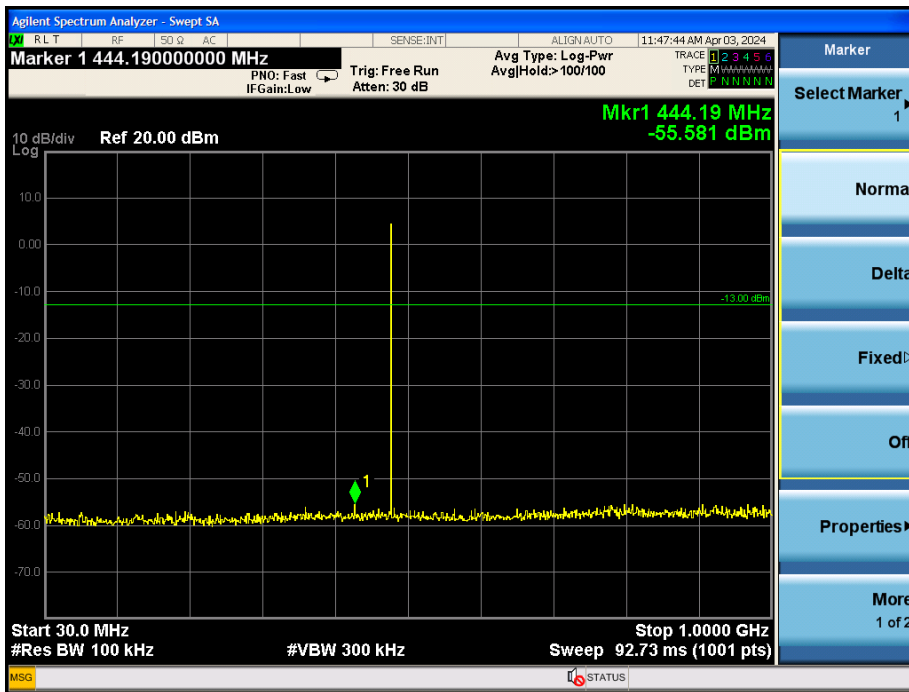
High Channel(492.4MHz)

Temperature:	26 °C	Relative Humidity:	54%
Pressure:	101KPa	Test Voltage :	DC 3.7V
Test Mode:	500.125MHz~522.400MHz		

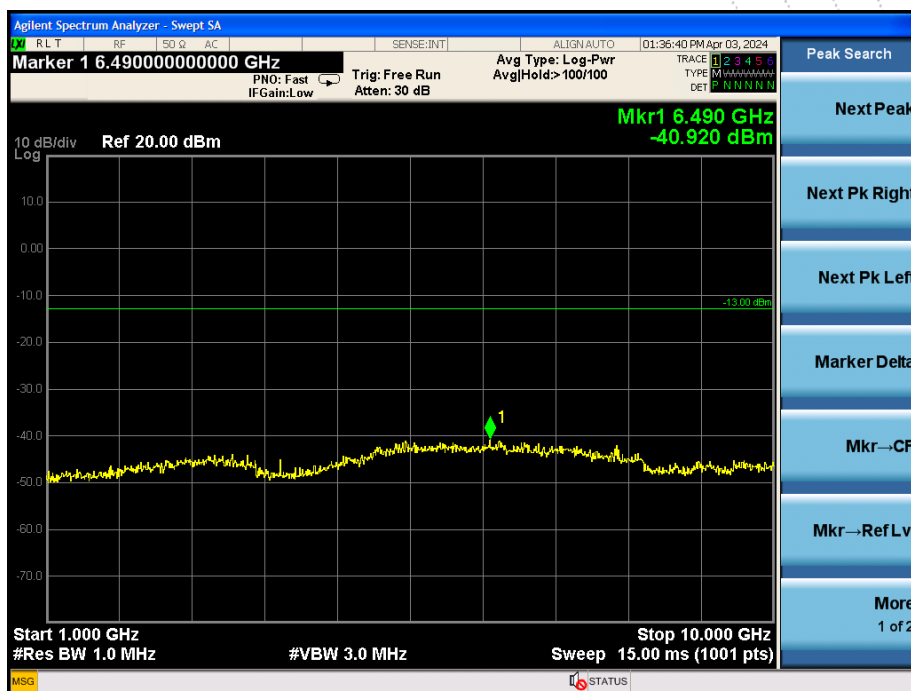
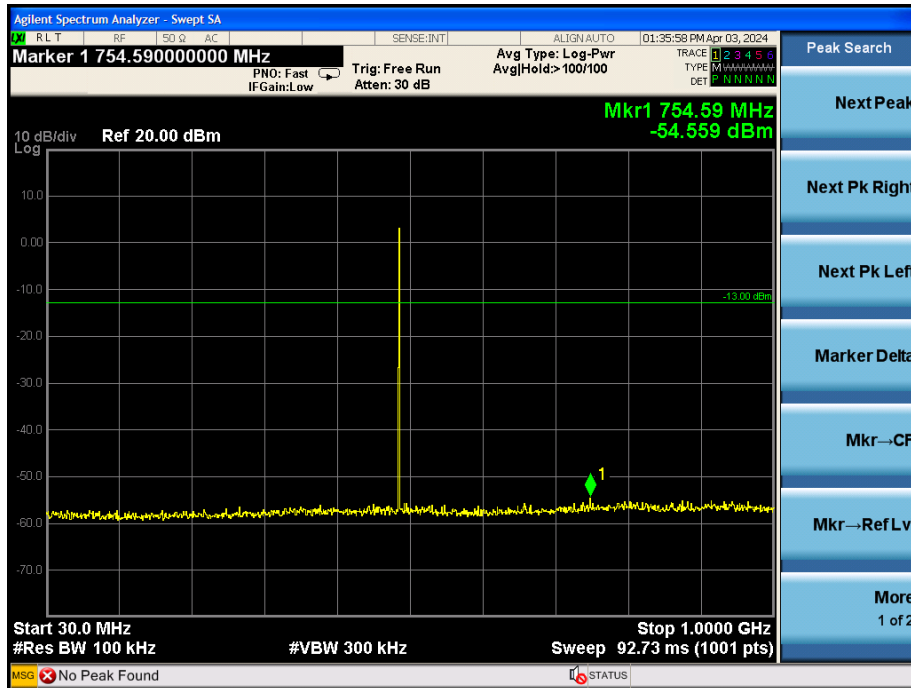
Low Channel(500.125MHz)

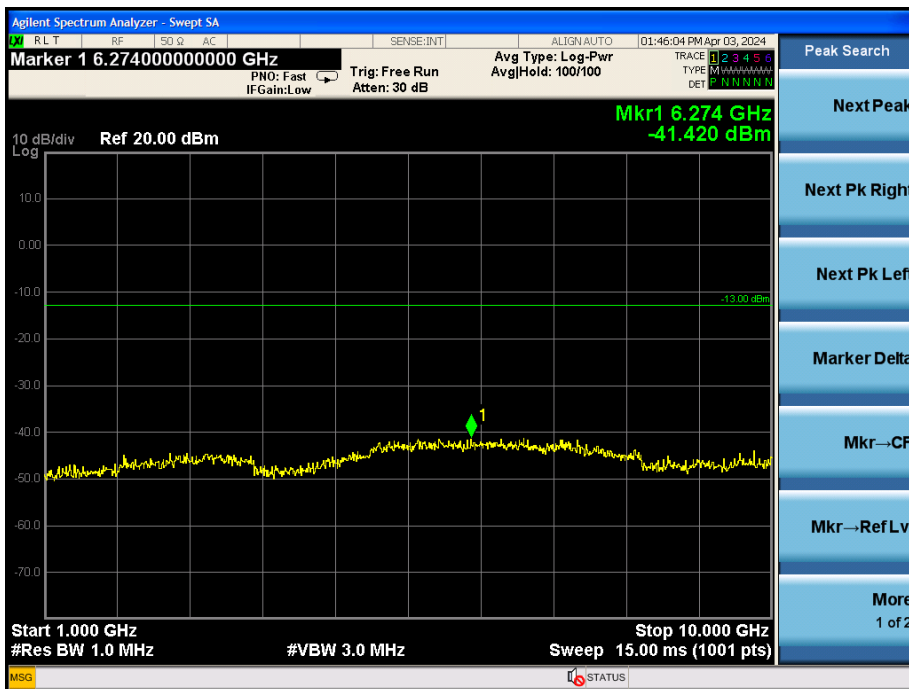
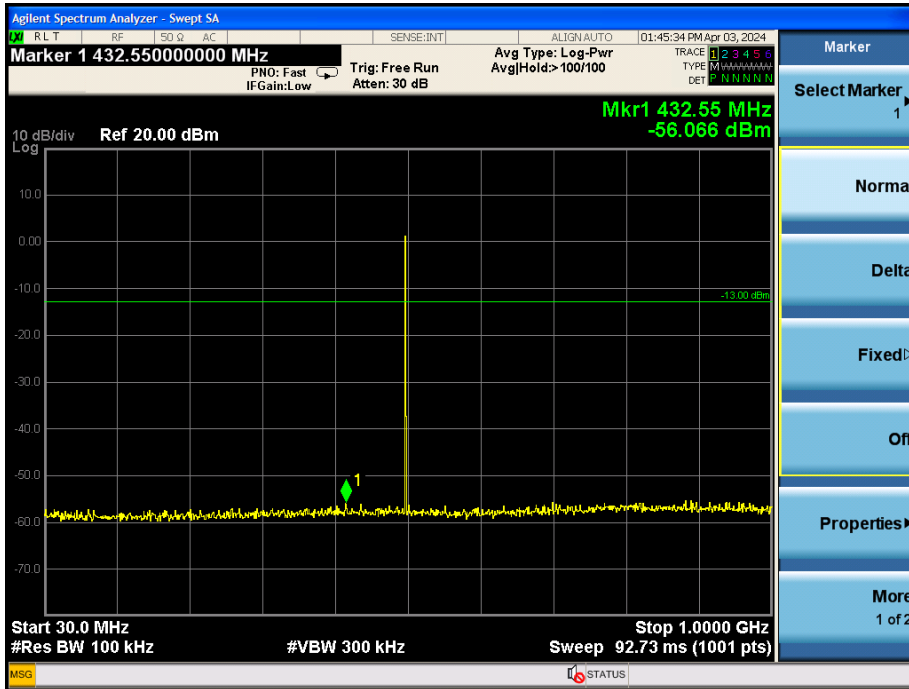
Middle Channel(511.375MHz)

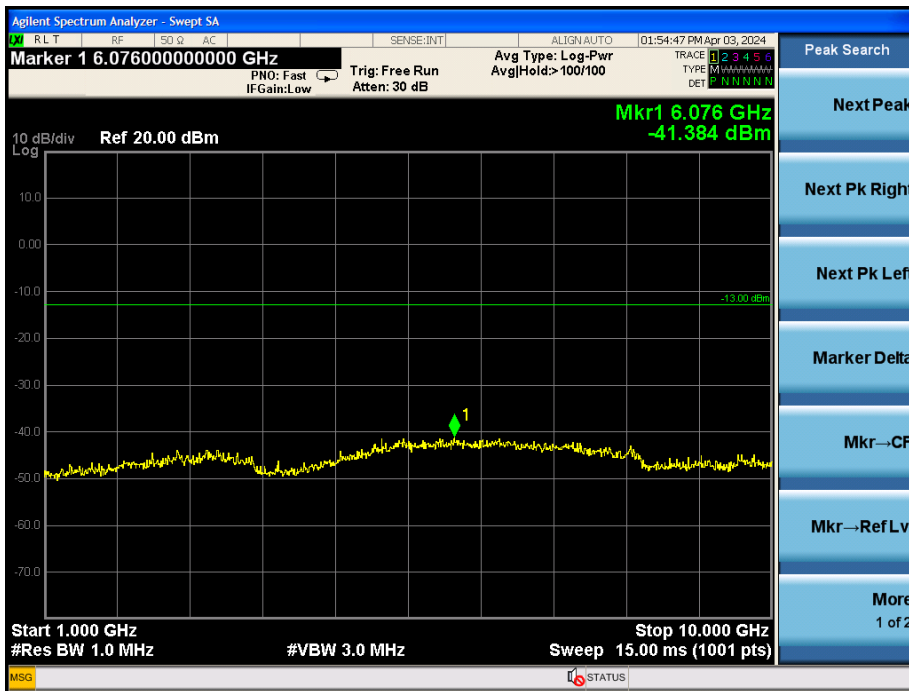
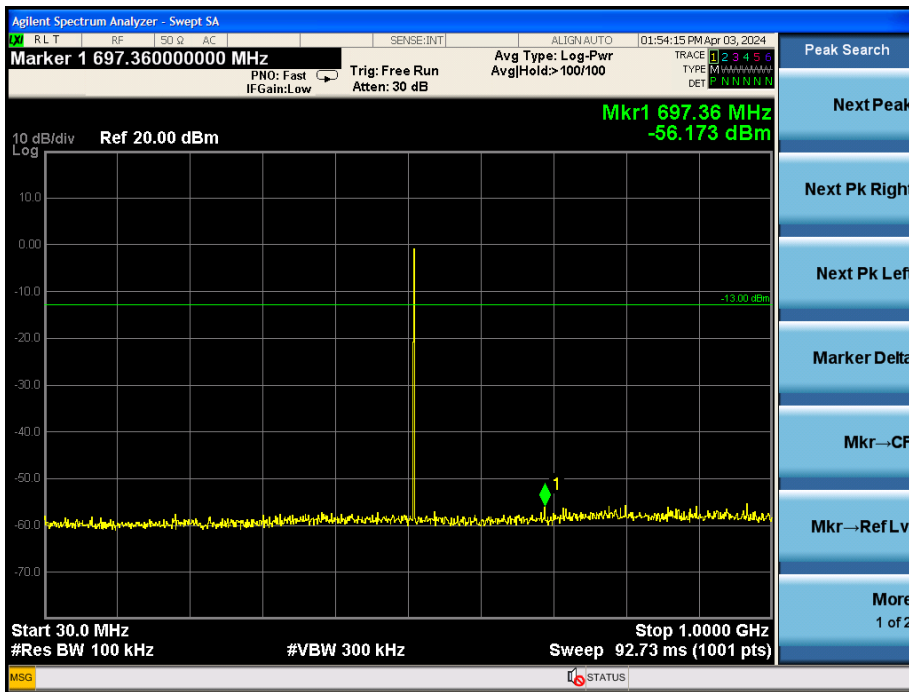
High Channel(522.4MHz)

11. Frequency Stability

11.1 Block Diagram Of Test Setup

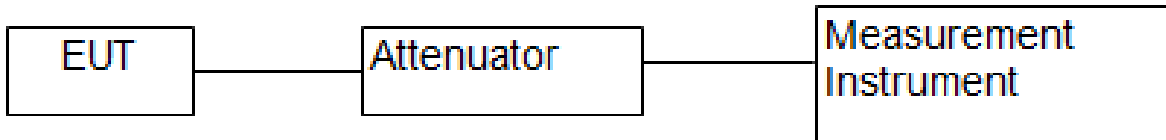

11.2 Limit

According to FCC 74.861

According to FCC 2.1055(a)(1), the frequency stability shall be measure with variation of ambient temperature from -30°C to $+50^{\circ}\text{C}$, and according to FCC 2.1055(d)(2), the frequency stability shall be measured with reducing primary supply voltage to the battery operating end point which is specified by the manufacturer.

According to FCC 74.861, the frequency tolerance of the transmitter shall be 0.005 percent.

11.3 Test Procedure

- 1 Setup the configuration of the ambient temperature form -30°C to 50°C with sufficient time. And measure the different power of the EUT with an artificial power from highest to end point voltage.
- 2 Set frequency counter center frequency to the right frequency needs to be measured.

11.4 EUT Operating Conditions

The EUT tested system was configured as the statements of 2.4 unless otherwise a special operating condition is specified in the follows during the testing.

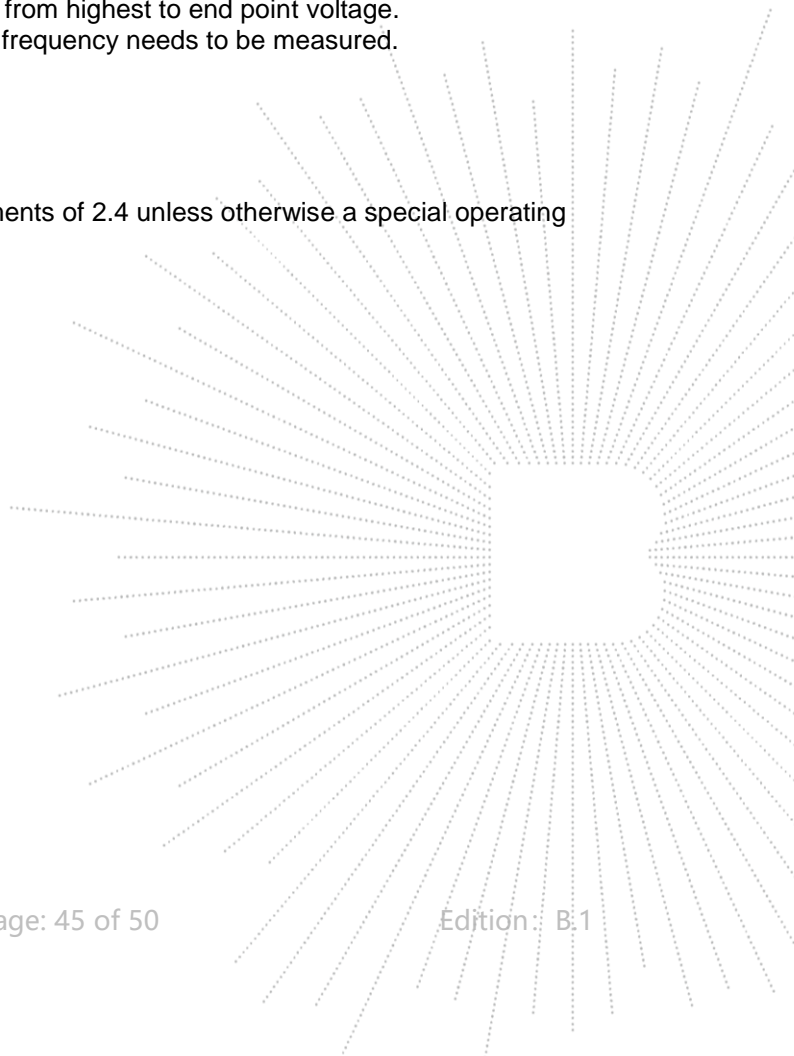

11.5 Test Result

Temperature:	26 °C	Relative Humidity:	54%
Pressure:	101KPa	Test Voltage :	DC 3.7V
Test Mode:	470.125MHz~492.400MHz		

Test conditions		Frequency Error		
		470.125 MHz	481.375 MHz	492.40 MHz
T _{min} (-30°C)	V _{min} (3.33V)	470.113	481.305	492.368
	V _{max} (4.07V)	470.108	481.285	492.346
T(-20°C)	V _{nom} (3.7V)	470.086	481.349	492.342
T(-10°C)	V _{nom} (3.7V)	470.036	481.348	492.342
T(0°C)	V _{nom} (3.7V)	470.106	481.295	492.319
T(10°C)	V _{nom} (3.7V)	470.034	481.353	492.402
T _{nom} (20°C)	V _{nom} (3.7V)	470.132	481.382	492.407
T(30°C)	V _{nom} (3.7V)	470.035	481.348	492.326
T(40°C)	V _{nom} (3.7V)	470.084	481.331	492.405
T _{max} (50°C)	V _{min} (3.33V)	470.037	481.346	492.373
	V _{max} (4.07V)	470.126	481.342	492.363
Max. frequency error (ppm)		14.89	14.54	14.22
Limit (ppm)		±50ppm		
End Point		DC 3.7V		

Temperature:	26 °C	Relative Humidity:	54%
Pressure:	101KPa	Test Voltage :	DC 3.7V
Test Mode:	500.125MHz~522.400MHz		

Test conditions		Frequency Error		
		500.125 MHz	511.375 MHz	522.40 MHz
T _{min} (-30°C)	V _{min} (3.33V)	500.083	511.329	522.398
	V _{max} (4.07V)	500.068	511.315	522.354
T(-20°C)	V _{nom} (3.7V)	500.040	511.372	522.329
T(-10°C)	V _{nom} (3.7V)	500.050	511.294	522.374
T(0°C)	V _{nom} (3.7V)	500.074	511.293	522.346
T(10°C)	V _{nom} (3.7V)	500.055	511.309	522.346
T _{nom} (20°C)	V _{nom} (3.7V)	500.132	511.383	522.408
T(30°C)	V _{nom} (3.7V)	500.056	511.290	522.314
T(40°C)	V _{nom} (3.7V)	500.071	511.320	522.325
T _{max} (50°C)	V _{min} (3.33V)	500.122	511.369	522.403
	V _{max} (4.07V)	500.052	511.348	522.375
Max. frequency error (ppm)		14.00	15.64	15.31
Limit (ppm)		±50ppm		
End Point		DC 3.7V		

12. Antenna Requirement

12.1 Limit

15.203 requirement: For intentional device, according to 15.203: an intentional radiator shall be designed to ensure that no antenna other than that furnished by the responsible party shall be used with the device.

12.2 Test Result

The EUT antenna is Integral Antenna, fulfill the requirement of this section.

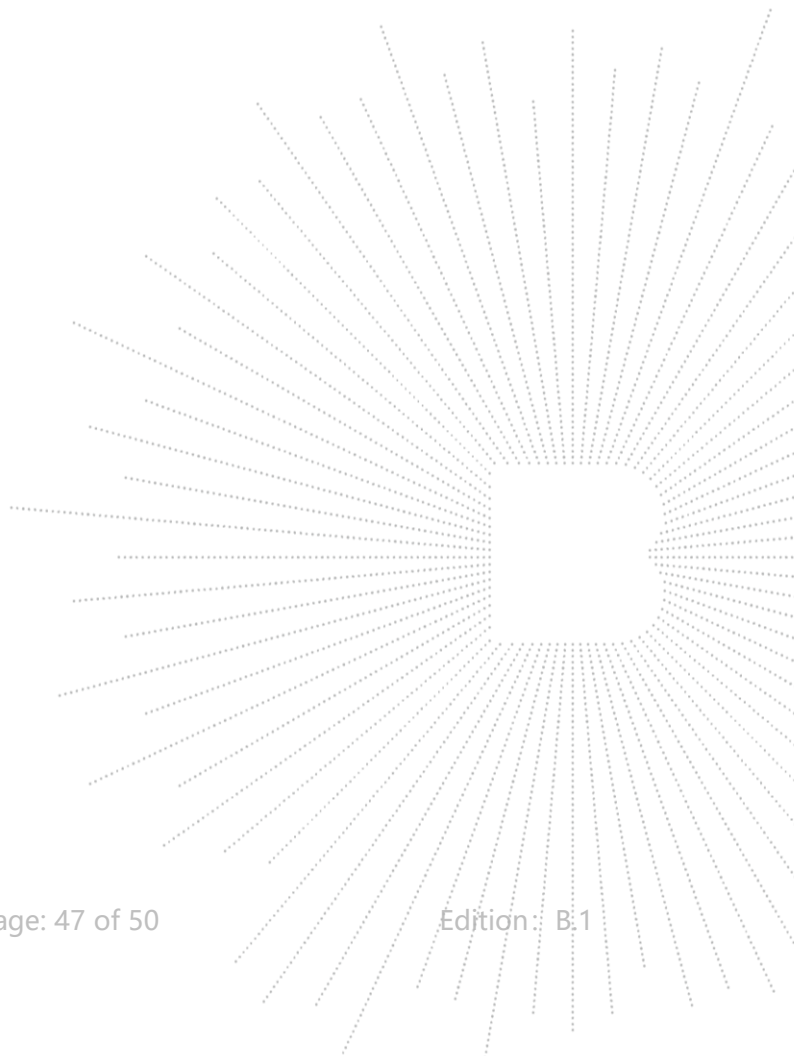

13. EUT Photographs

EUT Photo 1

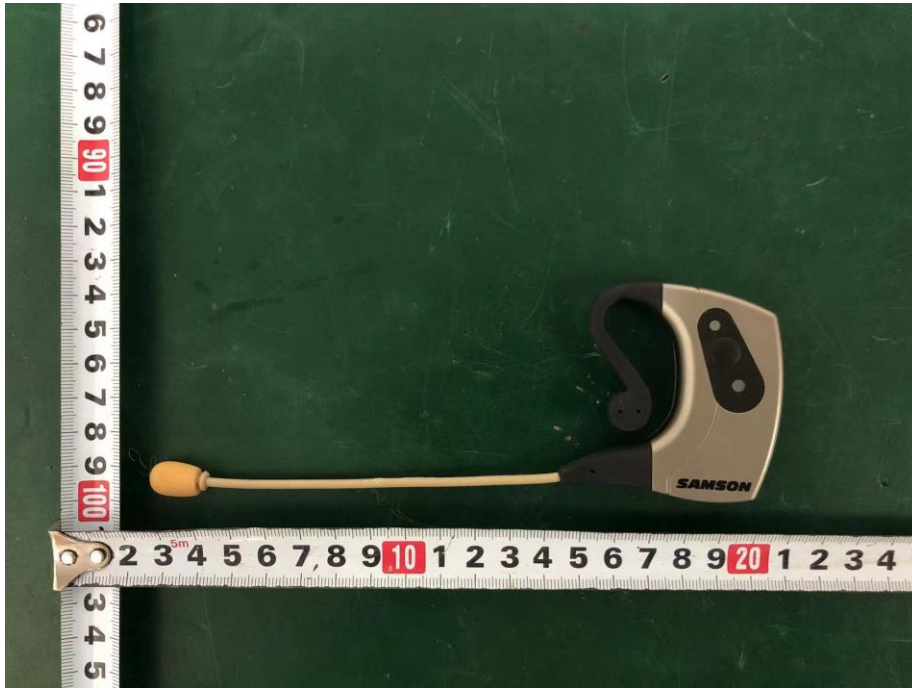

EUT Photo 2



NOTE: Appendix-Photographs Of EUT Constructional Details.

14. EUT Test Setup Photographs

Spurious Emission Test Setup (Below 1GHz)



Spurious Emission Test Setup (Above 1GHz)



STATEMENT

1. The equipment lists are traceable to the national reference standards.
2. The test report can not be partially copied unless prior written approval is issued from our lab.
3. The test report is invalid without the "special seal for inspection and testing".
4. The test report is invalid without the signature of the approver.
5. The test process and test result is only related to the Unit Under Test.
6. Sample information is provided by the client and the laboratory is not responsible for its authenticity.
7. The quality system of our laboratory is in accordance with ISO/IEC17025.
8. If there is any objection to this test report, the client should inform issuing laboratory within 15 days from the date of receiving test report.

Address:

1-2/F., Building B, Pengzhou Industrial Park, No.158, Fuyuan 1st Road, Zhancheng, Fuhai Subdistrict, Bao'an District, Shenzhen, Guangdong, China

TEL: 400-788-9558

P.C.: 518103

FAX: 0755-33229357

Website: <http://www.chnbctc.com>

E-Mail: bctc@bctc-lab.com.cn

※※※※※ END ※※※※※

