



FCC TEST REPORT FCC ID:2BFS9-SC-1000	
Report Number.....	ZHT-240407039E
Date of Test.....	Apr. 07, 2024 to Apr. 22, 2024
Date of issue.....	Apr. 22, 2024
Test Result.....	PASS
Testing Laboratory.....	Guangdong Zhonghan Testing Technology Co., Ltd.
Address	Room 104, Building 1, Yibaolai Industrial Park, Qiaotou Community, Fuhai Street, Bao'an District, Shenzhen, Guangdong, China
Applicant's name	Nizi Medical Technology (Shanghai) Co., Ltd
Address	Room 303, 3rd Floor, Building 4, No. 758 Huixian Road, Jiading District, Shanghai
Manufacturer's name	Nizi Medical Technology (Shanghai) Co., Ltd
Address	Room 303, 3rd Floor, Building 4, No. 758 Huixian Road, Jiading District, Shanghai
Test specification:	
Standard.....	FCC CFR Title 47 Part 15 Subpart C Section 15.247
Test procedure.....	KDB558074 D01 15.247 Meas Guidance v05r02
Non-standard test method	N/A
<p>This devicedescribed above has been tested by ZHT, and the test results show that the equipment under test (EUT) is in compliance with the FCC requirements. And it is applicable only to the tested sample identified in the report.</p> <p>This report shall not be reproduced except in full, without the written approval of ZHT, this document may be altered or revised by ZHT, personal only, and shall be noted in the revision of the document.</p>	
Product name.....	Head mounted pan tilt camera
Trademark	NEITZ
Model/Type reference.....	SC-1000, SC-100, SC-10
Model Difference.....	SC-1000 is tested model, other models are derivative models. The models are identical in circuit, only different on the model names. So the test data of SC-1000 can represent the remaining models.
Ratings.....	Input:AC 100-240V,50/60HZ,Output:DC 5V



Testing procedure and testing location:

Testing Laboratory.....: Guangdong Zhonghan Testing Technology Co., Ltd.

Address.....: Room 104, Building 1, Yibaolai Industrial Park, Qiaotou Community, Fuhai Street, Bao'an District, Shenzhen, Guangdong, China

Leon Li

Tested by (name + signature).....: Leon Li

Baret Wu

Reviewer (name + signature).....: Baret Wu



Approved (name + signature).....: Levi Lee



Table of Contents

	Page
1. VERSION	5
2. SUMMARY OF TEST RESULTS	6
2.1 TEST FACILITY	7
2.2 MEASUREMENT UNCERTAINTY	7
3. GENERAL INFORMATION	8
3.1 GENERAL DESCRIPTION OF EUT	8
3.2 DESCRIPTION OF TEST MODES	9
3.3 BLOCK DIGRAM SHOWING THE CONFIGURATION OF SYSTEM TESTED	10
3.4 DESCRIPTION OF SUPPORT UNITS(CONDUCTED MODE)	10
3.5EQUIPMENTS LIST FOR ALL TEST ITEMS	11
4. EMC EMISSION TEST	13
4.1 CONDUCTED EMISSION MEASUREMENT	13
4.1.1 POWER LINE CONDUCTED EMISSION Limits	13
4.1.2 TEST PROCEDURE	13
4.1.3 DEVIATION FROM TEST STANDARD	13
4.1.4 TEST SETUP	14
4.1.5 EUT OPERATING CONDITIONS	14
4.2 RADIATED EMISSION MEASUREMENT	17
4.2.1 RADIATED EMISSION LIMITS	17
4.2.2 TEST PROCEDURE	17
4.2.3 DEVIATION FROM TEST STANDARD	18
4.2.4 TEST SETUP	18
4.2.5 EUT OPERATING CONDITIONS	19
4.2.6 TEST RESULTS	19
5. RADIATED BAND EMISSIONMEASUREMENT	24
5.1 TEST REQUIREMENT:	24
5.2 TEST PROCEDURE	24
5.3 DEVIATION FROM TEST STANDARD	24
5.4 TEST SETUP	25
5.5 EUT OPERATING CONDITIONS	25
5.6 TEST RESULT	26
6. POWER SPECTRAL DENSITY TEST	28
6.1 APPLIED PROCEDURES / LIMIT	28
6.2 TEST PROCEDURE	28
6.3 DEVIATION FROM STANDARD	28
6.4 TEST SETUP	28
6.5 EUT OPERATION CONDITIONS	29



6.6 TEST RESULT29

7. CHANNEL BANDWIDTH 30

7.1 APPLIED PROCEDURES / LIMIT 30

7.2 TEST PROCEDURE 30

7.3 DEVIATION FROM STANDARD 30

7.4 TEST SETUP30

7.5 EUT OPERATION CONDITIONS 30

7.6 TEST RESULT31

8. AVERAGE OUTPUT POWER TEST 32

8.1 APPLIED PROCEDURES/LIMIT 32

8.2 TEST PROCEDURE 32

8.3 DEVIATION FROM STANDARD 32

8.4 TEST SETUP32

8.5 EUT OPERATION CONDITIONS 32

8.6 TEST RESULT32

9. CONDUCTED BAND EDGE AND SPURIOUS EMISSION 33

9.1 APPLICABLE STANDARD 33

9.2 TEST PROCEDURE 33

9.3 DEVIATION FROM STANDARD 33

9.4 TEST SETUP 33

9.5 EUT OPERATION CONDITIONS 33

9.6 TEST RESULTS 33

10. ANTENNA REQUIREMENT 34

11. APPENDIX 2.4G WIFI 35

12. TEST SETUP PHOTO 82

13. EUT CONSTRUCTIONAL DETAILS 82



1. VERSION

Report No.	Version	Description	Approved
ZHT-240407039E	Rev.01	Initial issue of report	Apr. 22, 2024



2. SUMMARY OF TEST RESULTS

Test procedures according to the technical standards:

FCC Part15 (15.247) , Subpart C			
Standard Section	Test Item	Result	Remark
FCC part 15.203/15.247 (b)(4)	Antenna requirement	PASS	
FCC part 15.207	AC Power Line Conducted Emission	PASS	
FCC part 15.247 (b)(3)	Conducted Average Output Power	PASS	
FCC part 15.247 (a)(2)	Channel Bandwidth	PASS	
FCC part 15.247 (e)	Power Spectral Density	PASS	
FCC part 15.247(d)	Band Edge	PASS	
FCC part 15.205/15.209	Spurious Emission	PASS	

NOTE:

(1) " N/A" denotes test is not applicable in this Test Report



2.1 TEST FACILITY

Guangdong Zhonghan Testing Technology Co., Ltd.
Add. : Room 104, Building 1, Yibaolai Industrial Park, Qiaotou Community, Fuhai Street, Bao'an District
Shenzhen, Guangdong, China

FCC Registration Number:255941
Designation Number: CN0325
IC Registered No.: 29832
CAB identifier: CN0143

2.2 MEASUREMENT UNCERTAINTY

The reported uncertainty of measurement $y \pm U$ · where expended uncertainty U is based on a standard uncertainty multiplied by a coverage factor of $k=2$ · providing a level of confidence of approximately 95 % ·

No.	Item	Uncertainty
1	Conducted Emission Test	$\pm 1.38\text{dB}$
2	RF conducted power	$\pm 0.16\text{dB}$
3	Conducted spurious emissions	$\pm 0.21\text{dB}$
4	All radiated emissions (9k-30MHz)	$\pm 4.68\text{dB}$
5	All radiated emissions (<1G)	$\pm 4.68\text{dB}$
6	All radiated emissions (>1G)	$\pm 4.89\text{dB}$
7	Temperature	$\pm 0.5^\circ\text{C}$
8	Humidity	$\pm 2\%$
9	Occupied Bandwidth	$\pm 4.96\%$



3. GENERAL INFORMATION

3.1 GENERAL DESCRIPTION OF EUT

Product Name:	Head mounted pan tilt camera
Test Model No.:	SC-1000
Hardware Version:	V1.0
Software Version:	V1.0
Sample(s) Status:	Engineer sample
Channel numbers:	802.11b/802.11g /802.11n(HT20):11
Operation Frequency:	802.11b/802.11g /802.11n(HT20): 2412-2462MHz
Channel separation:	5MHz
Modulation technology:	IEEE 802.11b: DQPSK/DBPSK/DSSS/CCK IEEE 802.11g: QPSK/BPSK/16QAM/64QAM/OFDM IEEE 802.11n: QPSK/BPSK/16QAM/64QAM/OFDM
Antenna Type:	PIFA antenna
Antenna gain:	3dBi
Ratings:	Input:AC 100-240V,50/60HZ,Output:DC 5V



Operation Frequency each of channel							
Channel	Frequency	Channel	Frequency	Channel	Frequency	Channel	Frequency
1	2412MHz	4	2427MHz	7	2442MHz	10	2457MHz
2	2417MHz	5	2432MHz	8	2447MHz	11	2462MHz
3	2422MHz	6	2437MHz	9	2452MHz	X	

Note:

In section 15.31(m), regards to the operating frequency range over 10 MHz, the Lowest frequency, the middle frequency, and the highest frequency of channel were selected to perform the test, and the selected channel see below:

Test channel	Frequency (MHz)
	802.11b/802.11g/802.11n(HT20)
Lowest channel	2412MHz
Middle channel	2437MHz
Highest channel	2462MHz

3.2 DESCRIPTION OF TEST MODES

Transmitting mode	Keep the EUT in continuously transmitting mode
Remark: EUT use new battery during the test,the dutycycle >98%, the test voltage was tuned from 85% to 115% of the nominal rated supply voltage, and found that the worst case was under the nominal rated supply condition. So the report just shows that condition's data.	

We have verified the construction and function in typical operation. All the test modes were carried out with the EUT in transmitting operation, which was shown in this test report and defined as follows:			
Pre-scan all kind of data rate in lowest channel, and found the follow list which it was worst case.			
Mode	802.11b	802.11g	802.11n(HT20)
Data rate	1Mbps	6Mbps	6.5Mbps



3.3 BLOCK DIGRAM SHOWING THE CONFIGURATION OF SYSTEM TESTED

Conduction Emission

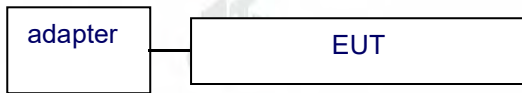

Radiated Emission

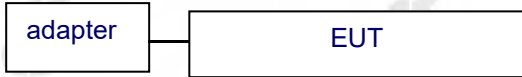

3.4 DESCRIPTION OF SUPPORT UNITS(CONDUCTED MODE)

The EUT has been tested as an independent unit together with other necessary accessories or support units. The following support units or accessories were used to form a representative test configuration during the tests.

Item	Equipment	Mfr/Brand	Model/Type No.	Series No.	Note
E-1	Adapter	N/A	HW-059200CHQ	N/A	AE

Item	Shielded Type	Ferrite Core	Length	Note

Note:

- (1) The support equipment was authorized by Declaration of Confirmation.
- (2) For detachable type I/O cable should be specified the length in cm in 『Length』 column.
- (3) The device does not have a voice recording function.



3.5EQUIPMENTS LIST FOR ALL TEST ITEMS

Radiation Test equipment

Item	Equipment	Manufacturer	Model	Last Cal.	Next Cal.
1	Receiver	R&S	ESCI	May 12, 2023	May 11, 2024
2	Loop antenna	EMCI	LAP600	May 12, 2023	May 11, 2024
3	Amplifier	Schwarzbeck	BBV 9743 B	May 12, 2023	May 11, 2024
4	Amplifier	Schwarzbeck	BBV 9718 B	May 12, 2023	May 11, 2024
5	Bilog Antenna	Schwarzbeck	VULB9162	May 17, 2023	May 16, 2024
6	Horn Antenna	Schwarzbeck	BBHA9120D	May 17, 2023	May 16, 2024
7	Horn Antenna	A.H.SYSTEMS	SAS574	May 12, 2023	May 11, 2024
8	Amplifier	AEROFLEX	100KHz-40GHz	May 12, 2023	May 11, 2024
9	Spectrum Analyzer	R&S	FSV40	May 12, 2023	May 11, 2024
10	CDNE	Schwarzbeck	CDNE M2 + CDNE M3	May 12, 2023	May 11, 2024
11	966 Anechoic Chamber	EMToni	9m6m6m	Nov. 25, 2021	Nov. 24, 2024
12	Spectrum Analyzer	KEYSIGHT	N9020A	May 12, 2023	May 11, 2024
13	WIDBAND RADIO COMMUNICATION TESTER	R&S	CMW500	May 12, 2023	May 11, 2024
14	Single Generator	Agilent	N5182A	May 12, 2023	May 11, 2024
15	Power Sensor	MWRFtest	MW100-RFCB	May 12, 2023	May 11, 2024
16	Audio analyzer	R&S	UPL	May 12, 2023	May 11, 2024
17	Single Generator	R&S	SMB100A	May 12, 2023	May 11, 2024
18	Power Amplifier Shielding Room	EMToni	2m3m3m	Nov. 25, 2021	Nov. 24, 2024



Equipment	Manufacturer	Model	Last Cal.	Next Cal.
Receiver	R&S	ESCI	May 12, 2023	May 11, 2024
LISN	R&S	ENV216	May 12, 2023	May 11, 2024
ISN CAT 6	Schwarzbeck	NTFM 8158	May 12, 2023	May 11, 2024
ISN CAT 5	Schwarzbeck	CAT5 8158	May 12, 2023	May 11, 2024
Capacitive Voltage Probe	Schwarzbeck	CVP 9222 C	May 12, 2023	May 11, 2024
Current Transformer Clamp	Schwarzbeck	SW 9605	May 12, 2023	May 11, 2024
CE Shielding Room	EMToni	9m4m3m	Nov. 25, 2021	Nov. 24, 2024

Conducted Test equipment

Equipment	Manufacturer	Model	Last Cal.	Next Cal.
Spectrum Analyzer	KEYSIGHT	N9020A	May 12, 2023	May 11, 2024
Single Generator	Agilent	N5182A	May 12, 2023	May 11, 2024



4. EMC EMISSION TEST

4.1 CONDUCTED EMISSION MEASUREMENT

Test Requirement:	FCC Part15 C Section 15.207
Test Method:	ANSI C63.10:2013
Test Frequency Range:	150KHz to 30MHz
Receiver setup:	RBW=9KHz, VBW=30KHz, Sweep time=auto

4.1.1 POWER LINE CONDUCTED EMISSION Limits

FREQUENCY (MHz)	Limit (dBuV)		Standard
	Quasi-peak	Average	
0.15 -0.5	66 - 56 *	56 - 46 *	FCC
0.50 -5.0	56.00	46.00	FCC
5.0 -30.0	60.00	50.00	FCC

Note:

(1) *Decreases with the logarithm of the frequency.

4.1.2 TEST PROCEDURE

- a. The EUT was placed 0.8 meters from the horizontal ground plane with EUT being connected to the power mains through a line impedance stabilization network (LISN). All other support equipments powered from additional LISN(s). The LISN provide 50 Ohm/ 50uH of coupling impedance for the measuring instrument.
- b. Interconnecting cables that hang closer than 40 cm to the ground plane shall be folded back and forth in the center forming a bundle 30 to 40 cm long.
- c. I/O cables that are not connected to a peripheral shall be bundled in the center. The end of the cable may be terminated, if required, using the correct terminating impedance. The overall length shall not exceed 1 m.
- d. LISN at least 80 cm from nearest part of EUT chassis.
- e. For the actual test configuration, please refer to the related Item –EUT Test Photos.

4.1.3 DEVIATION FROM TEST STANDARD

No deviation

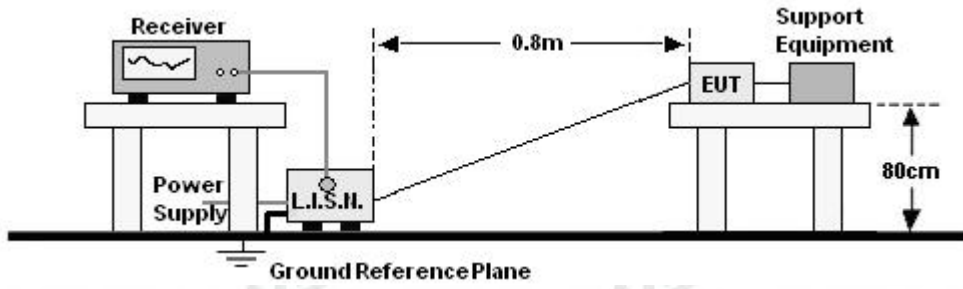

4.1.5 EUT OPERATING CONDITIONS

The EUT was configured for testing in a typical fashion (as a customer would normally use it). The EUT has been programmed to continuously transmit during test. This operating condition was tested and used to collect the included data.



4.1.6 test result

Temperature:	26°C	Relative Humidity:	54%
Pressure:	101kPa	Phase :	L
Test Voltage:	AC 120V/60Hz		

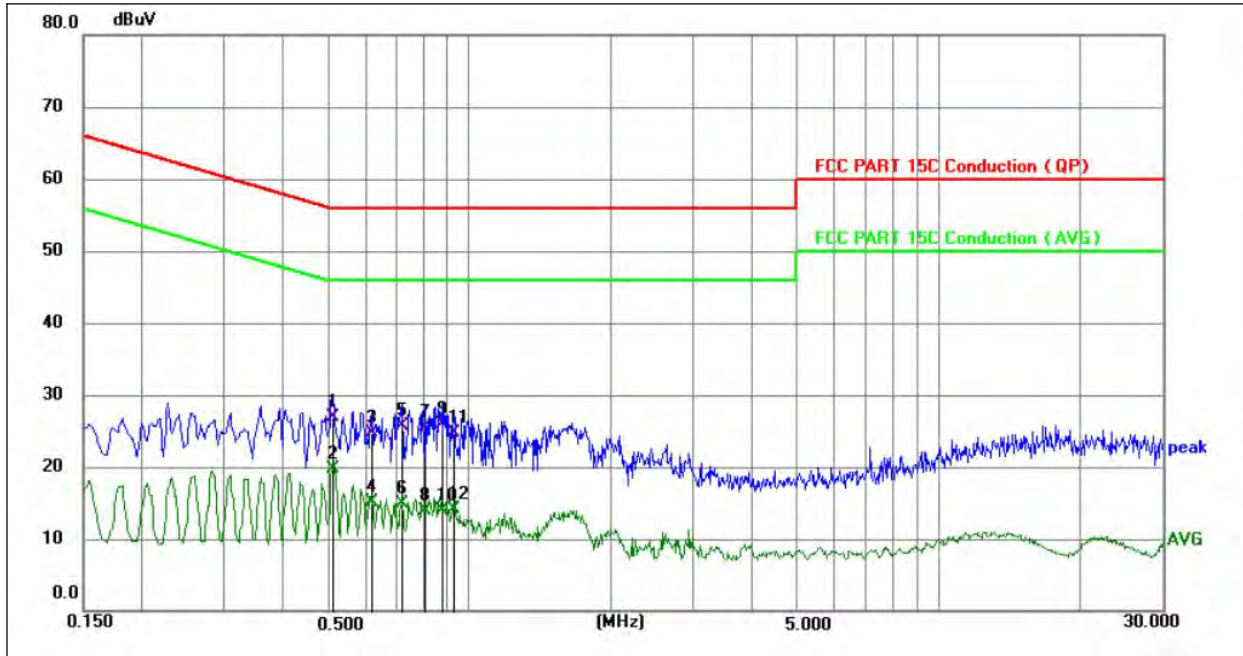

No.	Frequency (MHz)	Reading (dBuV)	Factor (dB)	Level (dBuV)	Limit (dBuV)	Margin (dB)	Detector	P/F	Remark
1	0.5100	16.93	9.89	26.82	56.00	-29.18	QP	P	
2 *	0.5100	9.84	9.89	19.73	46.00	-26.27	AVG	P	
3	0.6180	14.75	9.90	24.65	56.00	-31.35	QP	P	
4	0.6180	5.21	9.90	15.11	46.00	-30.89	AVG	P	
5	0.7170	15.80	9.90	25.70	56.00	-30.30	QP	P	
6	0.7170	4.97	9.90	14.87	46.00	-31.13	AVG	P	
7	0.8070	15.60	9.90	25.50	56.00	-30.50	QP	P	
8	0.8070	3.91	9.90	13.81	46.00	-32.19	AVG	P	
9	0.8745	16.08	9.90	25.98	56.00	-30.02	QP	P	
10	0.8745	3.93	9.90	13.83	46.00	-32.17	AVG	P	
11	0.9240	14.79	9.90	24.69	56.00	-31.31	QP	P	
12	0.9240	4.14	9.90	14.04	46.00	-31.96	AVG	P	



Temperature:	26°C	Relative Humidity:	54%
Pressure:	101kPa	Phase :	N
Test Voltage:	AC 120V/60Hz		

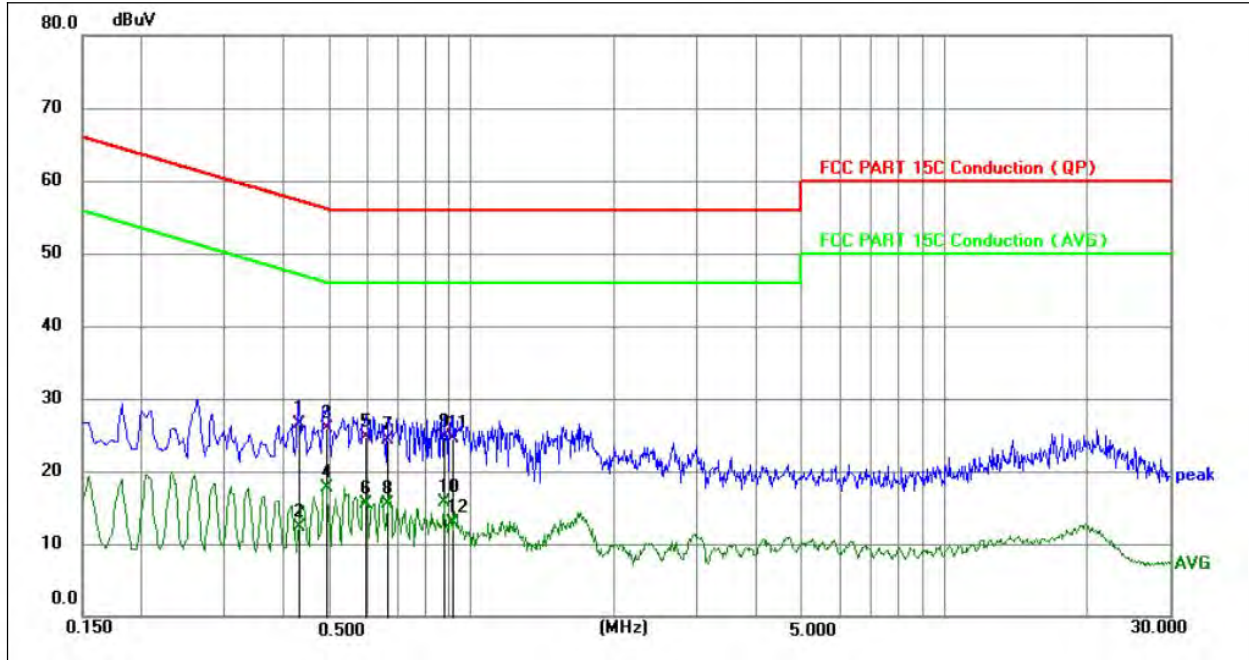

No.	Frequency (MHz)	Reading (dBuV)	Factor (dB)	Level (dBuV)	Limit (dBuV)	Margin (dB)	Detector	P/F	Remark
1	0.4290	16.65	9.90	26.55	57.27	-30.72	QP	P	
2	0.4290	2.39	9.90	12.29	47.27	-34.98	AVG	P	
3	0.4920	16.05	9.89	25.94	56.13	-30.19	QP	P	
4 *	0.4920	7.74	9.89	17.63	46.13	-28.50	AVG	P	
5	0.5955	14.76	9.89	24.65	56.00	-31.35	QP	P	
6	0.5955	5.66	9.89	15.55	46.00	-30.45	AVG	P	
7	0.6630	14.50	9.90	24.40	56.00	-31.60	QP	P	
8	0.6630	5.58	9.90	15.48	46.00	-30.52	AVG	P	
9	0.8745	14.75	9.90	24.65	56.00	-31.35	QP	P	
10	0.8745	5.86	9.90	15.76	46.00	-30.24	AVG	P	
11	0.9150	14.51	9.90	24.41	56.00	-31.59	QP	P	
12	0.9150	2.92	9.90	12.82	46.00	-33.18	AVG	P	

Notes:

- 1.An initial pre-scan was performed on the line and neutral lines with peak detector.
- 2.Quasi-Peak and Average measurement were performed at the frequencies with maximized peak emission.
- 3.Measurement Level = Reading level + Correct Factor



Test Requirement:	FCC Part15 C Section 15.209				
Test Method:	ANSI C63.10:2013				
Test Frequency Range:	9kHz to 25GHz				
Test site:	Measurement Distance: 3m				
Receiver setup:	Frequency	Detector	RBW	VBW	Value
	9KHz-150KHz	Quasi-peak	200Hz	600Hz	Quasi-peak
	150KHz-30MHz	Quasi-peak	9KHz	30KHz	Quasi-peak
	30MHz-1GHz	Quasi-peak	100KHz	300KHz	Quasi-peak
	Above 1GHz	Peak	1MHz	3MHz	Peak
Peak		1MHz	10Hz	Average	

4.2.1 RADIATED EMISSION LIMITS

Frequencies (MHz)	Field Strength (micorvolts/meter)	Measurement Distance (meters)
0.009~0.490	2400/F(KHz)	300
0.490~1.705	24000/F(KHz)	30
1.705~30.0	30	30
30~88	100	3
88~216	150	3
216~960	200	3
Above 960	500	3

LIMITS OF RADIATED EMISSION MEASUREMENT

FREQUENCY (MHz)	Limit (dBuV/m) (at 3M)	
	PEAK	AVERAGE
Above 1000	74	54

Notes:

- (1) The limit for radiated test was performed according to FCC PART 15C.
- (2) The tighter limit applies at the band edges.
- (3) Emission level (dBuV/m)=20log Emission level (uV/m).

4.2.2 TEST PROCEDURE

Below 1GHz test procedure as below:

- a. The EUT was placed on the top of a rotating table 0.8 meters above the ground at a 3 meter semi-anechoiccamber. The table was rotated 360 degrees to determine the position of the highest radiation.
- b. The EUT was set 3 meters away from the interference-receiving antenna, which was mounted on the top of available-height antenna tower.

- c. The antenna height is varied from one meter to four meters above the ground to determine the maximum value of the field strength. Both horizontal and vertical polarizations of the antenna are set to make the measurement.
- d. For each suspected emission, the EUT was arranged to its worst case and then the antenna was tuned to heights from 1 meter to 4 meters (for the test frequency of below 30MHz, the antenna was tuned to heights 1meter) and the rotatable table was turned from 0 degrees to 360 degrees to find the maximum reading.
- e. The test-receiver system was set to Peak Detect Function and Specified Bandwidth with Maximum Hold Mode.
- f. If the emission level of the EUT in peak mode was 10dB lower than the limit specified, then testing could be stopped and the peak values of the EUT would be reported. Otherwise the emissions that did not have 10dB margin would be re-tested one by one using peak, quasi-peak or average method as specified and then reported in a data sheet.

Above 1GHz test procedure as below:

- g. Different from above is the test site, change from Semi- Anechoic Chamber to fully Anechoic Chamber and change from table 0.8 meter to 1.5 meter (Above 18GHz the distance is 1 meter and table is 1.5 meter).
- h. Test the EUT in the lowest channel, the middle channel, the Highest channel

Note:

Both horizontal and vertical antenna polarities were tested and performed pretest to three orthogonal axis. The worst case emissions were reported

4.2.3 DEVIATION FROM TEST STANDARD

No deviation

4.2.4 TEST SETUP

(A) Radiated Emission Test-Up Frequency Below 30MHz

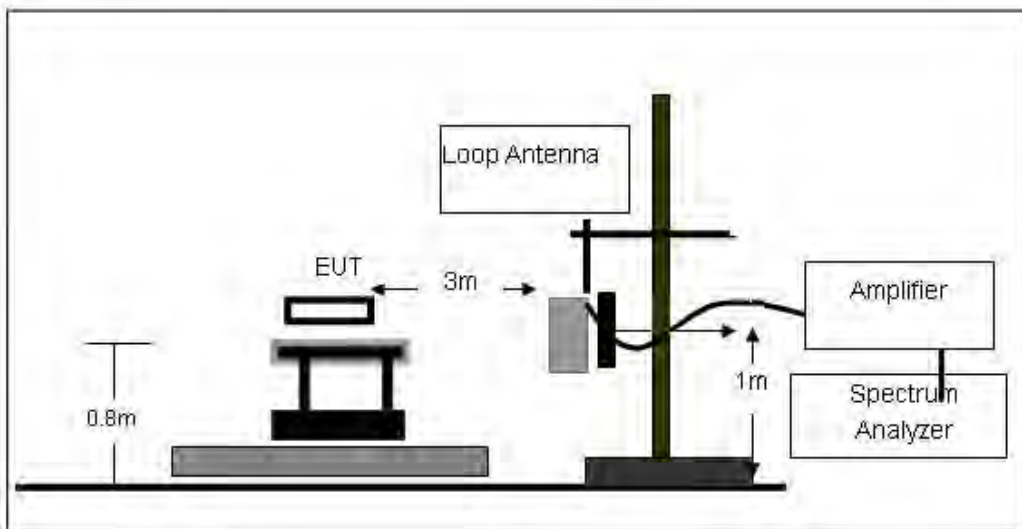

(B) Radiated Emission Test-Up Frequency 30MHz~1GHz

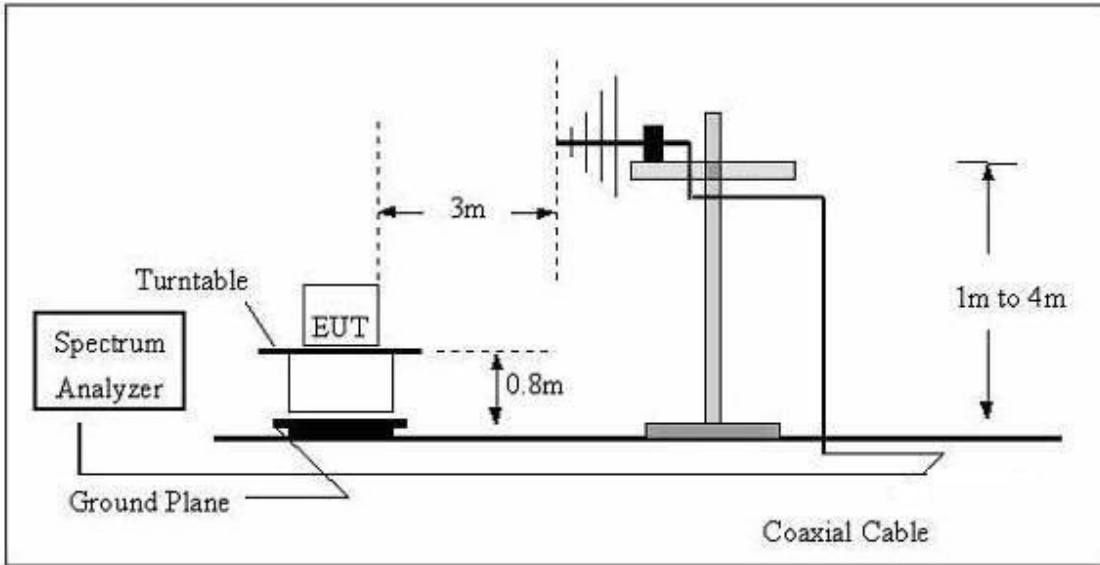

(C) Radiated Emission Test-Up Frequency Above 1GHz

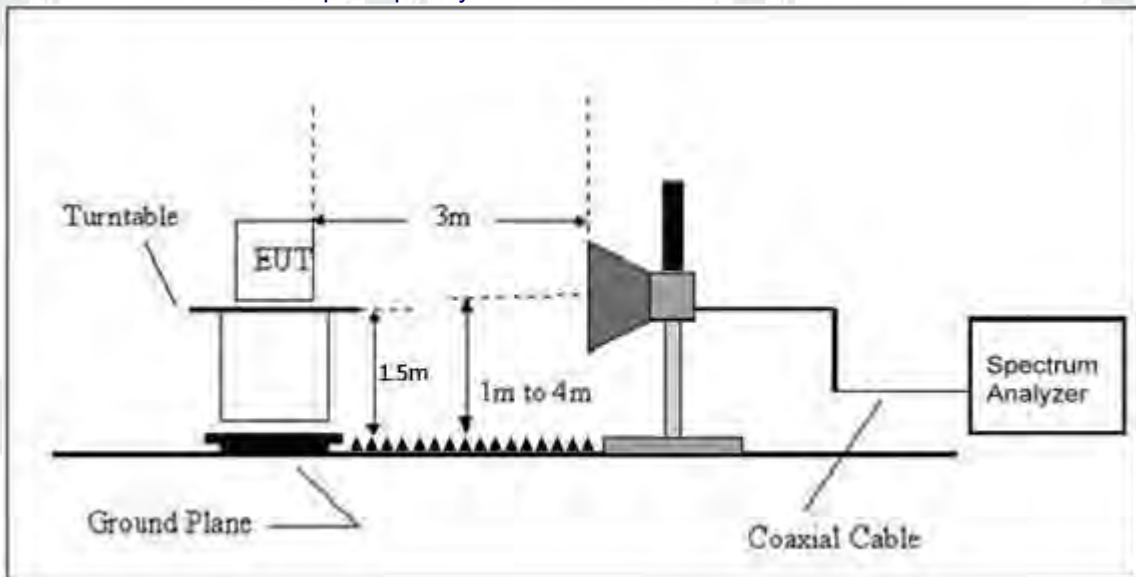

4.2.5 EUT OPERATING CONDITIONS

The EUT tested system was configured as the statements of 2.4 Unless otherwise a special operating condition is specified in the follows during the testing.

4.2.6 TEST RESULTS

Between 9KHz – 30MHz

The emission from 9 kHz to 30MHz was pre-tested and found the result was 20dB lower than the limit, and according to 15.31(o) & RSS-Gen 6.13, the test result no need to reported.



Between 30MHz – 1GHz

Temperature :	25.1 °C	Relative Humidity :	50%
Pressure :	101kPa	Polarization :	Horizontal
Test Voltage :	AC 120V/60Hz		

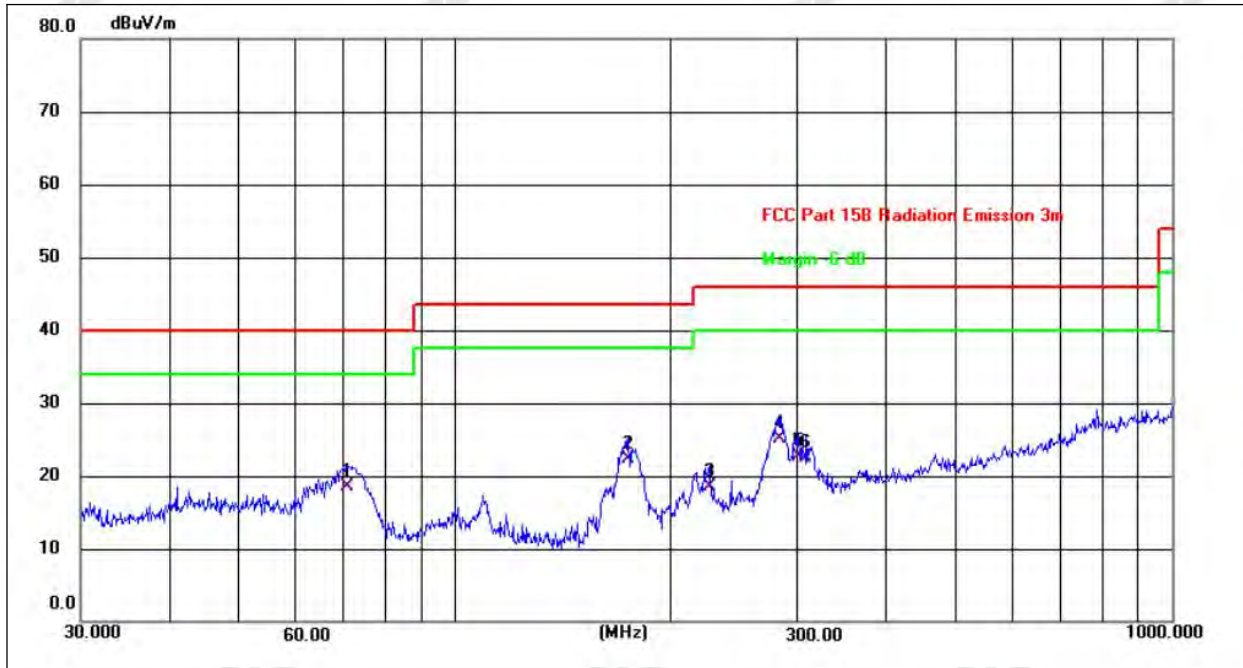

No.	Frequency (MHz)	Reading (dBuV)	Factor (dB/m)	Level (dBuV/m)	Limit (dBuV/m)	Margin (dB)	Detector	Height (cm)	Azimuth (deg.)	P/F	Remark
1	70.5836	31.61	-13.12	18.49	40.00	-21.51	QP			P	
2	174.4241	34.91	-12.65	22.26	43.50	-21.24	QP			P	
3	226.0994	28.35	-9.93	18.42	46.00	-27.58	QP			P	
4 *	282.9852	33.58	-8.39	25.19	46.00	-20.81	QP			P	
5	301.4224	30.70	-8.01	22.69	46.00	-23.31	QP			P	
6	308.9126	30.29	-7.83	22.46	46.00	-23.54	QP			P	



Temperature :	25.1℃	Relative Humidity :	50%
Pressure :	101kPa	Polarization :	Vertical
Test Voltage :	AC 120V/60Hz		

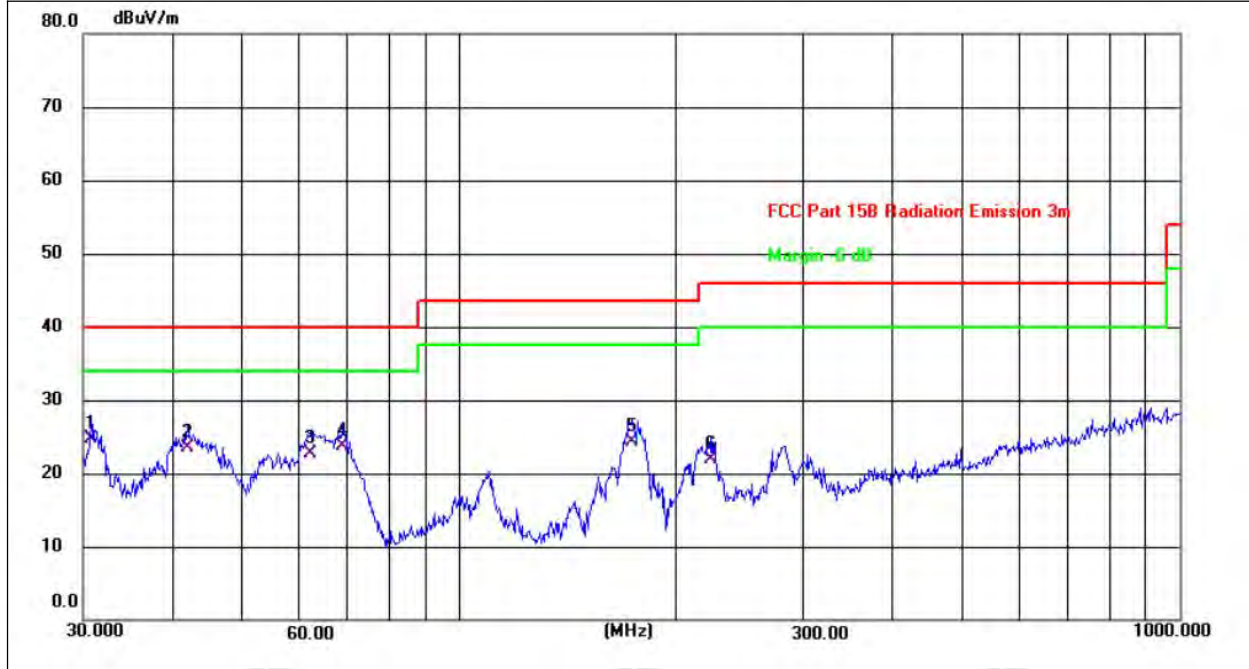

No.	Frequency (MHz)	Reading (dBuV)	Factor (dB/m)	Level (dBuV/m)	Limit (dBuV/m)	Margin (dB)	Detector	Height (cm)	Azimuth (deg.)	P/F	Remark
1 *	30.7454	36.06	-11.32	24.74	40.00	-15.26	QP			P	
2	41.8595	33.00	-9.51	23.49	40.00	-16.51	QP			P	
3	61.9950	33.12	-10.47	22.65	40.00	-17.35	QP			P	
4	68.8721	36.29	-12.68	23.61	40.00	-16.39	QP			P	
5	173.2050	37.05	-12.71	24.34	43.50	-19.16	QP			P	
6	223.7333	31.84	-10.02	21.82	46.00	-24.18	QP			P	

Remarks:

1. Final Level = Receiver Read level + Antenna Factor + Cable Loss – Preamplifier Factor
2. The emission levels of other frequencies are very lower than the limit and not show in test report.
3. The test data shows only the worst case 802.11b mode (Low Channel:2412MHz).



1GHz~25GHz

Polar (H/V)	Frequency (MHz)	Meter Reading (dBuV)	Pre-amplifier (dB)	Cable Loss (dB)	Antenna Factor (dB)	Emission Level (dBuV/m)	Limits (dBuV/m)	Margin (dB)	Detect or Type
802.11b									
Low Channel:2412MHz									
V	4824.00	56.27	30.55	5.77	24.66	56.15	74	-17.85	PK
V	4824.00	42.38	30.55	5.77	24.66	42.26	54	-11.74	AV
H	4824.00	59.61	30.33	6.32	24.55	60.15	74	-13.85	PK
H	4824.00	44.29	30.33	6.32	24.55	44.83	54	-9.17	AV
Middle Channel:2437MHz									
V	4874.00	55.18	30.55	5.77	24.66	55.06	74	-18.94	PK
V	4874.00	41.55	30.55	5.77	24.66	41.43	54	-12.57	AV
H	4874.00	58.73	30.33	6.32	24.55	59.27	74	-14.73	PK
H	4874.00	43.74	30.33	6.32	24.55	44.28	54	-9.72	AV
High Channel:2462MHz									
V	4924.00	54.66	30.55	5.77	24.66	54.54	74	-19.46	PK
V	4924.00	44.77	30.55	5.77	24.66	44.65	54	-9.35	AV
H	4924.00	54.93	30.33	6.32	24.55	55.47	74	-18.53	PK
H	4924.00	41.55	30.33	6.32	24.55	42.09	54	-11.91	AV
802.11g									
Low Channel:2412MHz									
V	4824.00	57.34	30.55	5.77	24.66	57.22	74	-16.78	PK
V	4824.00	47.55	30.55	5.77	24.66	47.43	54	-6.57	AV
H	4824.00	54.74	30.33	6.32	24.55	55.28	74	-18.72	PK
H	4824.00	41.51	30.33	6.32	24.55	42.05	54	-11.95	AV
Middle Channel:2437MHz									
V	4874.00	55.27	30.55	5.77	24.66	55.15	74	-18.85	PK
V	4874.00	41.77	30.55	5.77	24.66	41.65	54	-12.35	AV
H	4874.00	56.53	30.33	6.32	24.55	57.07	74	-16.93	PK
H	4874.00	42.53	30.33	6.32	24.55	43.07	54	-10.93	AV
High Channel:2462MHz									
V	4924.00	59.57	30.55	5.77	24.66	59.45	74	-14.55	PK
V	4924.00	43.62	30.55	5.77	24.66	43.50	54	-10.50	AV
H	4924.00	55.52	30.33	6.32	24.55	56.06	74	-17.94	PK
H	4924.00	44.78	30.33	6.32	24.55	45.32	54	-8.68	AV
802.11n 20									
Low Channel:2412MHz									
V	4824.00	59.23	30.55	5.77	24.66	59.11	74	-14.89	PK
V	4824.00	43.78	30.55	5.77	24.66	43.66	54	-10.34	AV
H	4824.00	55.75	30.33	6.32	24.55	56.29	74	-17.71	PK
H	4824.00	42.72	30.33	6.32	24.55	43.26	54	-10.74	AV
Middle Channel:2437MHz									
V	4874.00	57.82	30.55	5.77	24.66	57.70	74	-16.30	PK
V	4874.00	41.68	30.55	5.77	24.66	41.56	54	-12.44	AV
H	4874.00	56.28	30.33	6.32	24.55	56.82	74	-17.18	PK
H	4874.00	43.61	30.33	6.32	24.55	44.15	54	-9.85	AV
High Channel:2462MHz									
V	4924.00	57.12	30.55	5.77	24.66	57.00	74	-17.00	PK
V	4924.00	41.62	30.55	5.77	24.66	41.50	54	-12.50	AV
H	4924.00	59.28	30.33	6.32	24.55	59.82	74	-14.18	PK
H	4924.00	41.32	30.33	6.32	24.55	41.86	54	-12.14	AV



Remark:

1. Emission Level = Meter Reading + Antenna Factor + Cable Loss – Pre-amplifier, Margin= Emission Level - Limit
2. If peak below the average limit, the average emission was no test.
3. The amplitude of spurious emissions which are attenuated by more than 20dB below the permissible value has no need to be reported.
4. For above 1GHz, the test result of peak was 20dB below to the limit of peak, which can be compliant to the average limit, so just peak value was recorded.



5. RADIATED BAND EMISSION MEASUREMENT

5.1 TEST REQUIREMENT:

Test Requirement:	FCC Part15 C Section 15.209 and 15.205				
Test Method:	ANSI C63.10: 2013				
Test Frequency Range:	All of the restrict bands were tested, only the worst band's (2310MHz to 2500MHz) data was showed.				
Test site:	Measurement Distance: 3m				
Receiver setup:	Frequency	Detector	RBW	VBW	Value
	Above 1GHz	Peak	1MHz	3MHz	Peak
		Average	1MHz	3MHz	Average

LIMITS OF RADIATED EMISSION MEASUREMENT (Above 1000MHz)

FREQUENCY (MHz)	Class B (dBuV/m) (at 3M)	
	PEAK	AVERAGE
Above 1000	74	54

Notes:

- (1) The limit for radiated test was performed according to FCC PART 15C.
- (2) The tighter limit applies at the band edges.
- (3) Emission level (dBuV/m)=20log Emission level (uV/m).

5.2 TEST PROCEDURE

Above 1GHz test procedure as below:

- a. 1. The EUT was placed on the top of a rotating table 1.5 meters above the ground at a 3 meter camber. The table was rotated 360 degrees to determine the position of the highest radiation.
- b. The EUT was set 3 meters away from the interference-receiving antenna, which was mounted on the top of a variable-height antenna tower.
- c. The antenna height is varied from one meter to four meters above the ground to determine the maximum value of the field strength. Both horizontal and vertical polarizations of the antenna are set to make the measurement.
- d. For each suspected emission, the EUT was arranged to its worst case and then the antenna was tuned to heights from 1 meter to 4 meters and the rota table was turned from 0 degrees to 360 degrees to find the maximum reading.
- e. The test-receiver system was set to Peak Detect Function and Specified Bandwidth with Maximum Hold Mode.
- f. If the emission level of the EUT in peak mode was 10dB lower than the limit specified, then testing could bestopped and the peak values of the EUT would be reported. Otherwise the emissions that did not have 10dBmargin would be re-tested one by one using peak, quasi-peak or average method as specified and then reportedin a data sheet.
- g. Test the EUT in the lowest channel,the Highest channel

Note:

Both horizontal and vertical antenna polarities were tested and performed pretest to three orthogonal axis. The worst case emissions were reported

5.3 DEVIATION FROM TEST STANDARD

No deviation

Radiated Emission Test-Up Frequency Above 1GHz

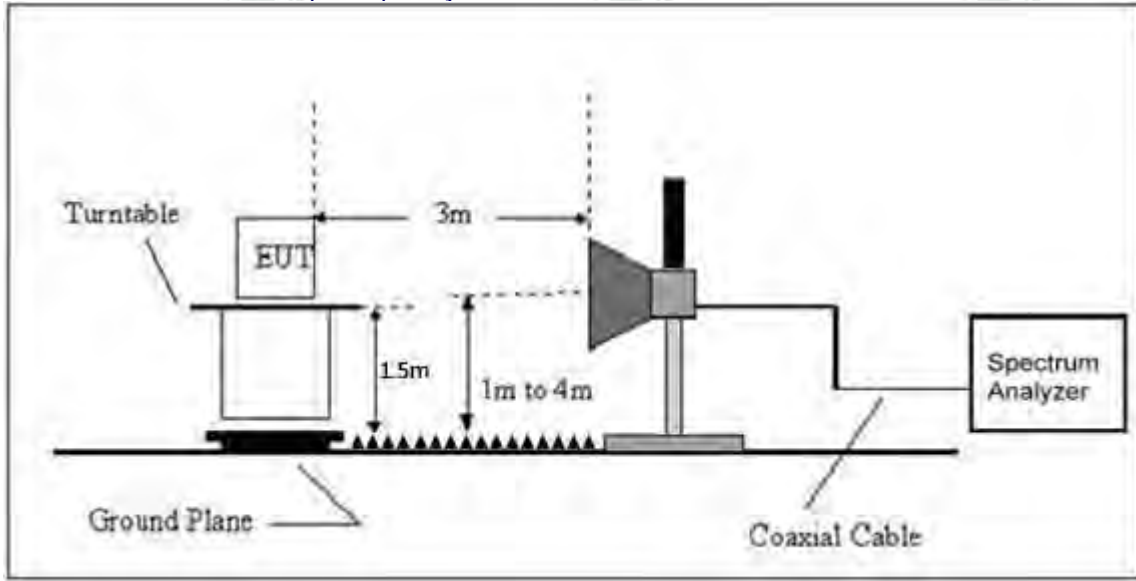

5.5 EUT OPERATING CONDITIONS

The EUT tested system was configured as the statements of 2.3 Unless otherwise a special operating condition is specified in the follows during the testing.



5.6 TEST RESULT

	Polar (H/V)	Frequency (MHz)	Meter Reading (dBuV)	Pre-amplifier (dB)	Cable Loss (dB)	Antenna Factor (dB/m)	Emission level (dBuV/m)	Limit (dBuV/m)	Margin (dB)	Detector Type	Result
802.11b	LowChannel 2412MHz										
	H	2390.00	59.45	30.22	4.85	23.98	58.06	74	-15.94	PK	PASS
	H	2390.00	47.52	30.22	4.85	23.98	46.13	54	-7.87	AV	PASS
	H	2400.00	60.17	30.22	4.85	23.98	58.78	74	-15.22	PK	PASS
	H	2400.00	47.82	30.22	4.85	23.98	46.43	54	-7.57	AV	PASS
	V	2390.00	59.18	30.22	4.85	23.98	57.79	74	-16.21	PK	PASS
	V	2390.00	47.57	30.22	4.85	23.98	46.18	54	-7.82	AV	PASS
	V	2400.00	60.02	30.22	4.85	23.98	58.63	74	-15.37	PK	PASS
	V	2400.00	46.57	30.22	4.85	23.98	45.18	54	-8.82	AV	PASS
	High Channel 2462MHz										
	H	2483.50	60.14	30.22	4.85	23.98	58.75	74	-15.25	PK	PASS
	H	2483.50	47.72	30.22	4.85	23.98	46.33	54	-7.67	AV	PASS
	H	2500.00	59.52	30.22	4.85	23.98	58.13	74	-15.87	PK	PASS
	H	2500.00	47.54	30.22	4.85	23.98	46.15	54	-7.85	AV	PASS
	V	2483.50	61.14	30.22	4.85	23.98	59.75	74	-14.25	PK	PASS
	V	2483.50	46.88	30.22	4.85	23.98	45.49	54	-8.51	AV	PASS
V	2500.00	61.21	30.22	4.85	23.98	59.82	74	-14.18	PK	PASS	
V	2500.00	46.18	30.22	4.85	23.98	44.79	54	-9.21	AV	PASS	
802.11g	Low Channel 2412MHz										
	H	2390.00	61.51	30.22	4.85	23.98	60.12	74	-13.88	PK	PASS
	H	2390.00	48.31	30.22	4.85	23.98	46.92	54	-7.08	AV	PASS
	H	2400.00	60.57	30.22	4.85	23.98	59.18	74	-14.82	PK	PASS
	H	2400.00	48.74	30.22	4.85	23.98	47.35	54	-6.65	AV	PASS
	V	2390.00	62.79	30.22	4.85	23.98	61.4	74	-12.6	PK	PASS
	V	2390.00	46.19	30.22	4.85	23.98	44.8	54	-9.2	AV	PASS
	V	2400.00	61.49	30.22	4.85	23.98	60.1	74	-13.9	PK	PASS
	V	2400.00	46.75	30.22	4.85	23.98	45.36	54	-8.64	AV	PASS
	High Channel 2462MHz										
	H	2483.50	55.47	30.22	4.85	23.98	54.08	74	-19.92	PK	PASS
	H	2483.50	46.42	30.22	4.85	23.98	45.03	54	-8.97	AV	PASS
	H	2500.00	59.65	30.22	4.85	23.98	58.26	74	-15.74	PK	PASS
	H	2500.00	47.17	30.22	4.85	23.98	45.78	54	-8.22	AV	PASS
	V	2483.50	62.31	30.22	4.85	23.98	60.92	74	-13.08	PK	PASS
	V	2483.50	48.23	30.22	4.85	23.98	46.84	54	-7.16	AV	PASS
V	2500.00	59.32	30.22	4.85	23.98	57.93	74	-16.07	PK	PASS	
V	2500.00	47.26	30.22	4.85	23.98	45.87	54	-8.13	AV	PASS	
802.11n20	Low Channel 2412MHz										
	H	2390.00	62.12	30.22	4.85	23.98	60.73	74	-13.27	PK	PASS
	H	2390.00	46.75	30.22	4.85	23.98	45.36	54	-8.64	AV	PASS
	H	2400.00	61.75	30.22	4.85	23.98	60.36	74	-13.64	PK	PASS
	H	2400.00	47.41	30.22	4.85	23.98	46.02	54	-7.98	AV	PASS
	V	2390.00	60.24	30.22	4.85	23.98	58.85	74	-15.15	PK	PASS
	V	2390.00	46.52	30.22	4.85	23.98	45.13	54	-8.87	AV	PASS
	V	2400.00	62.14	30.22	4.85	23.98	60.75	74	-13.25	PK	PASS
	V	2400.00	48.38	30.22	4.85	23.98	46.99	54	-7.01	AV	PASS
	High Channel 2462MHz										
	H	2483.50	60.12	30.22	4.85	23.98	58.73	74	-15.27	PK	PASS
	H	2483.50	47.25	30.22	4.85	23.98	45.86	54	-8.14	AV	PASS
	H	2500.00	61.95	30.22	4.85	23.98	60.56	74	-13.44	PK	PASS
	H	2500.00	48.35	30.22	4.85	23.98	46.96	54	-7.04	AV	PASS
	V	2483.50	61.97	30.22	4.85	23.98	60.58	74	-13.42	PK	PASS



V	2483.50	48.75	30.22	4.85	23.98	47.36	54	-6.64	AV	PASS
V	2500.00	61.72	30.22	4.85	23.98	60.33	74	-13.67	PK	PASS
V	2500.00	46.75	30.22	4.85	23.98	45.36	54	-8.64	AV	PASS

Remark:

1. Emission Level = Meter Reading + Antenna Factor + Cable Loss – Pre-amplifier, Margin= Emission Level - Limit



6. POWER SPECTRAL DENSITY TEST

Test Requirement:	FCC Part15 C Section 15.247 (e)
Test Method:	KDB558074 D0115.247 Meas Guidancev05r02

6.1 APPLIED PROCEDURES / LIMIT

FCC Part15 (15.247) , Subpart C				
Section	Test Item	Limit	Frequency Range (MHz)	Result
15.247	Power Spectral Density	8dBm/3kHz	2400-2483.5	PASS

6.2 TEST PROCEDURE

1. Set analyzer center frequency to DTS channel center frequency.
2. Set the span to 1.5 times the DTS bandwidth.
3. Set the RBW to: $3\text{ kHz} \leq \text{RBW} \leq 100\text{ kHz}$.
4. Set the VBW $\geq 3 \times \text{RBW}$.
5. Detector = average
6. Sweep time = auto couple.
7. Trace mode = max hold.
8. Allow trace to fully stabilize.
9. Use the peak marker function to determine the maximum amplitude level within the RBW.
10. If measured value exceeds limit, reduce RBW (no less than 3 kHz) and repeat.

6.3 DEVIATION FROM STANDARD

No deviation.

6.4 TEST SETUP





The EUT tested system was configured as the statements of 2.1 Unless otherwise a special operating condition is specified in the follows during the testing.

6.6 TEST RESULT

Temperature :	25.9°C	Relative Humidity :	52%
Pressure :	101kPa	Test Voltage :	DC 5V

Please refer to APPENDIX 2.4G WIFI



7. CHANNEL BANDWIDTH

Test Requirement:	FCC Part15 C Section 15.247 (a)(2)
Test Method:	KDB558074 D0115.247 Meas Guidancev05r02

7.1 APPLIED PROCEDURES / LIMIT

FCC Part15 (15.247) , Subpart C				
Section	Test Item	Limit	Frequency Range (MHz)	Result
15.247(a)(2)	Bandwidth	>= 500KHz (6dB bandwidth)	2400-2483.5	PASS

7.2 TEST PROCEDURE

1. Set RBW = 100 kHz.
2. Set the video bandwidth (VBW) ≥ 3 xRBW.
3. Detector = Peak.
4. Trace mode = max hold.
5. Sweep = auto couple.
6. Allow the trace to stabilize.
7. Measure the maximum width of the emission that is constrained by the frequencies associated with the two outermost amplitude points (upper and lower frequencies) that are attenuated by 6 dB relative to the maximum level measured in the fundamental emission.

7.3 DEVIATION FROM STANDARD

No deviation.

7.4 TEST SETUP



7.5 EUT OPERATION CONDITIONS

The EUT tested system was configured as the statements of 2.4 Unless otherwise a special operating condition is specified in the follows during the testing.



7.6 TEST RESULT

Temperature :	25.8°C	Relative Humidity :	52%
Pressure :	101kPa	Test Voltage :	DC 5V
Test Mode :	TX Mode		

Please refer to APPENDIX 2.4G WIFI



8. AVERAGE OUTPUT POWER TEST

Test Requirement:	FCC Part15 C Section 15.247 (b)(3)
Test Method:	KDB558074 D0115.247 Meas Guidancev05r02

8.1 APPLIED PROCEDURES/LIMIT

FCC Part15 (15.247) , Subpart C				
Section	Test Item	Limit	Frequency Range (MHz)	Result
15.247(b)(3)	Average Output Power	1 watt or 30dBm	2400-2483.5	PASS

8.2 TEST PROCEDURE

- a. The EUT was directly connected to the Power Analyzer

8.3 DEVIATION FROM STANDARD

No deviation.

8.4 TEST SETUP



8.5 EUT OPERATION CONDITIONS

The EUT tested system was configured as the statements of 2.4 Unless otherwise a special operating condition is specified in the follows during the testing.

8.6 TEST RESULT

Temperature :	25.3°C	Relative Humidity :	55%
Pressure :	101kPa	Test Voltage :	DC 5V

Please refer to APPENDIX 2.4G WIFI



9. CONDUCTED BAND EDGE AND SPURIOUS EMISSION

Test Requirement:	FCC Part15 C Section 15.247 (d)
Test Method:	KDB558074 D0115.247 Meas Guidancev05r02

9.1 APPLICABLE STANDARD

in any 100 kHz bandwidth outside the frequency bands in which the spread spectrum intentional radiator in operating, the radio frequency power that is produced by the intentional radiator shall be at least 30dB below that in the 100kHz bandwidth within the band that contains the highest level of the desired power, In addition, radiated emissions which fall in the restricted bands, as defined in§15.205(a), must also comply with the radiated emission limits specified in15.209(a).

9.2 TEST PROCEDURE

Using the following spectrum analyzer setting:

- A) Set the RBW = 100KHz.
- B) Set the VBW = 300KHz.
- C) Sweep time = auto couple.
- D) Detector function = average
- E) Trace mode = max hold.
- F) Allow trace to fully stabilize.

9.3 DEVIATION FROM STANDARD

No deviation.

9.4 TEST SETUP



9.5 EUT OPERATION CONDITIONS

The EUT tested system was configured as the statements of 2.4 Unless otherwise a special operating condition is specified in the follows during the testing.

9.6 TEST RESULTS

Please refer to APPENDIX 2.4G WIFI



10. ANTENNA REQUIREMENT

Standard requirement:	FCC Part15 C Section 15.203 /247(b)(4)
<p>15.203 requirement: An intentional radiator shall be designed to ensure that no antenna other than that furnished by the responsible party shall be used with the device. The use of a permanently attached antenna or of an antenna that uses a unique coupling to the intentional radiator, the manufacturer may design the unit so that a broken antenna can be replaced by the user, but the use of a standard antenna jack or electrical connector is prohibited.</p> <p>15.247(b) (4) requirement: (4) The conducted output power limit specified in paragraph (b) of this section is based on the use of antennas with directional gains that do not exceed 6 dBi. Except as shown in paragraph (c) of this section, if transmitting antennas of directional gain greater than 6 dBi are used, the conducted output power from the intentional radiator shall be reduced below the stated values in paragraphs (b)(1), (b)(2), and (b)(3) of this section, as appropriate, by the amount in dB that the directional gain of the antenna exceeds 6 dBi.</p>	
EUT Antenna:	
The antenna is PIFA Antenna, the best case gain of the antenna is 3dBi, reference to the appendix II for details	



11. APPENDIX 2.4G WIFI

Duty Cycle

Condition	Mode	Frequency (MHz)	Antenna	Duty Cycle (%)	Correction Factor (dB)
NVNT	b	2412	Ant1	98.82	0
NVNT	b	2437	Ant1	98.94	0
NVNT	b	2462	Ant1	98.82	0
NVNT	g	2412	Ant1	64.29	1.92
NVNT	g	2437	Ant1	62.96	2.01
NVNT	g	2462	Ant1	64.29	1.92
NVNT	n20	2412	Ant1	62.96	2.01
NVNT	n20	2437	Ant1	62.96	2.01
NVNT	n20	2462	Ant1	61.54	2.11



Test Graphs

Duty Cycle NVNT b 2412MHz Ant1

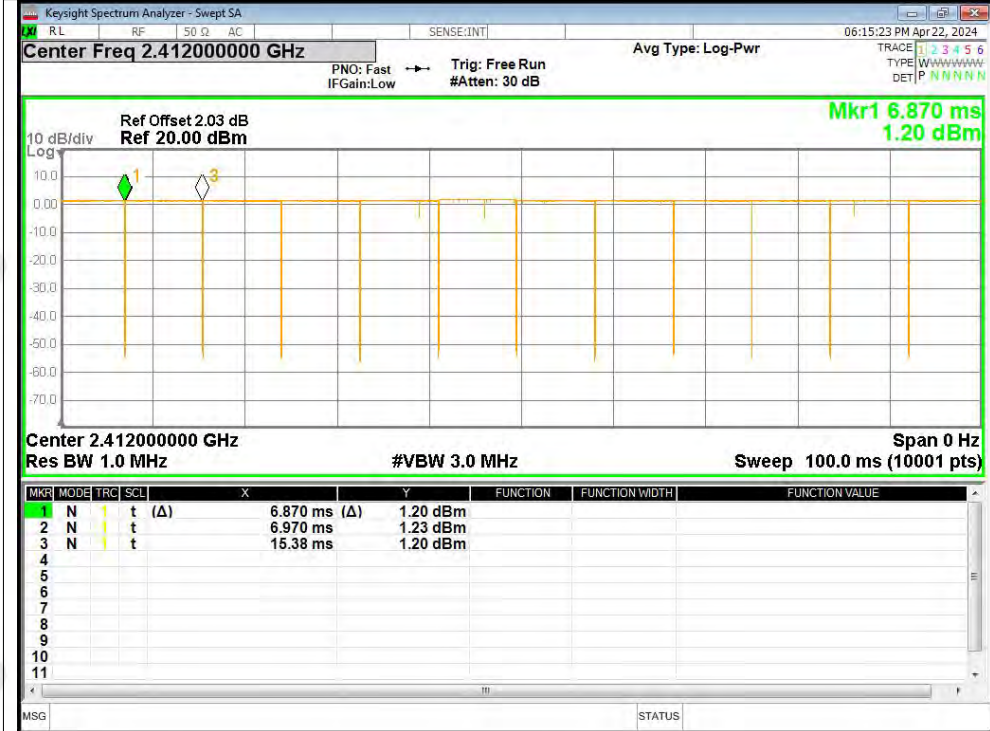

Duty Cycle NVNT b 2437MHz Ant1

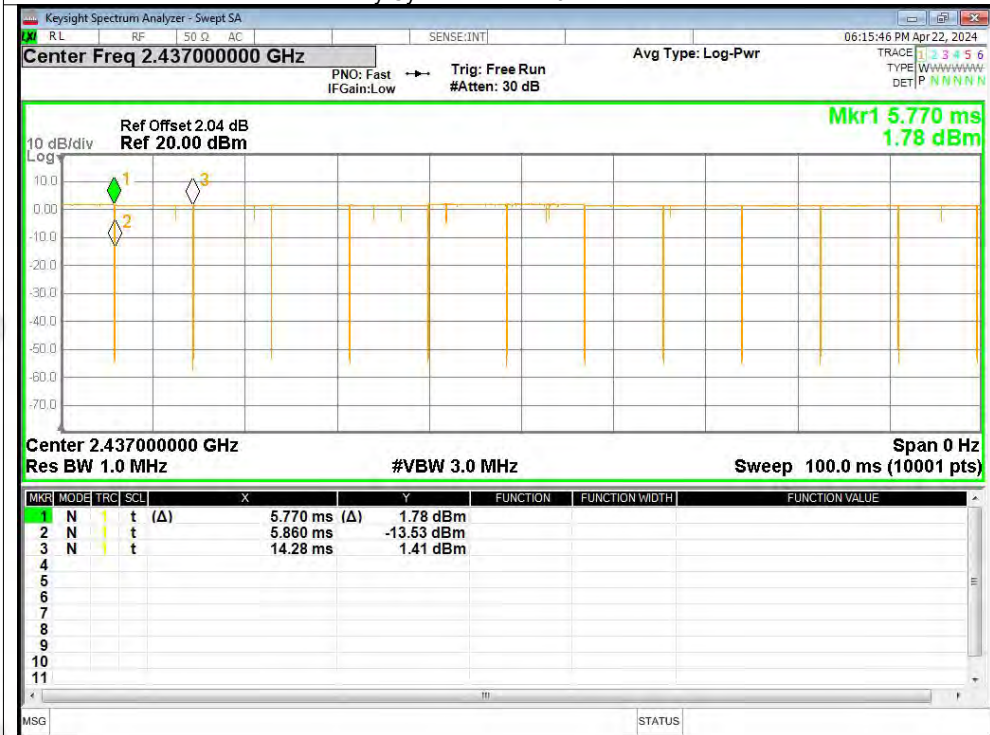



Duty Cycle NVNT b 2462MHz Ant1

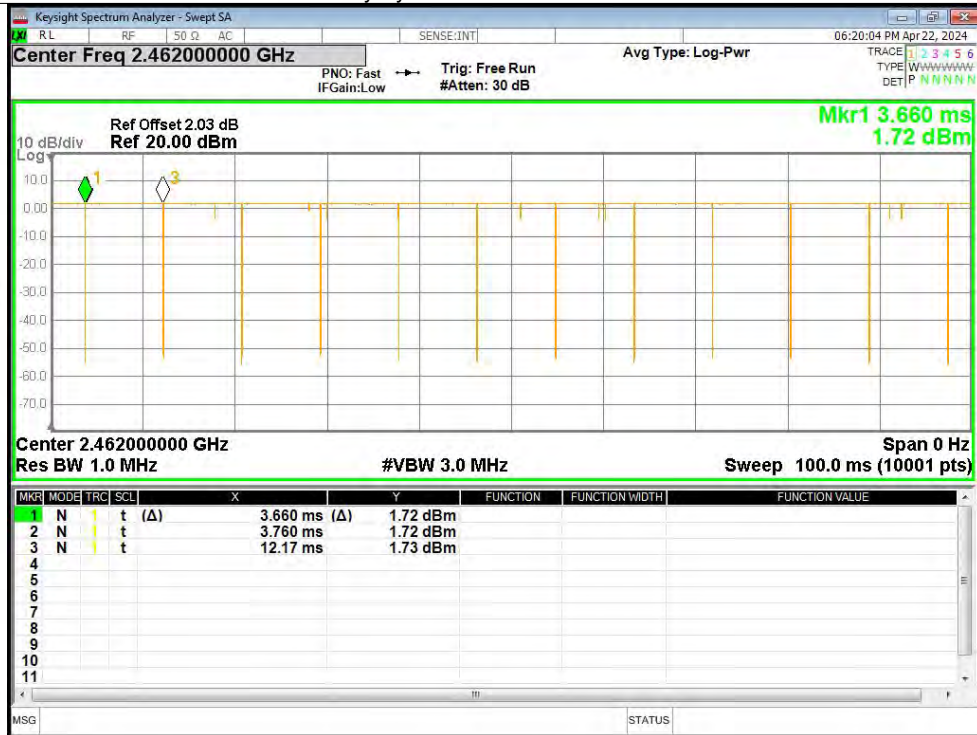

Duty Cycle NVNT g 2412MHz Ant1

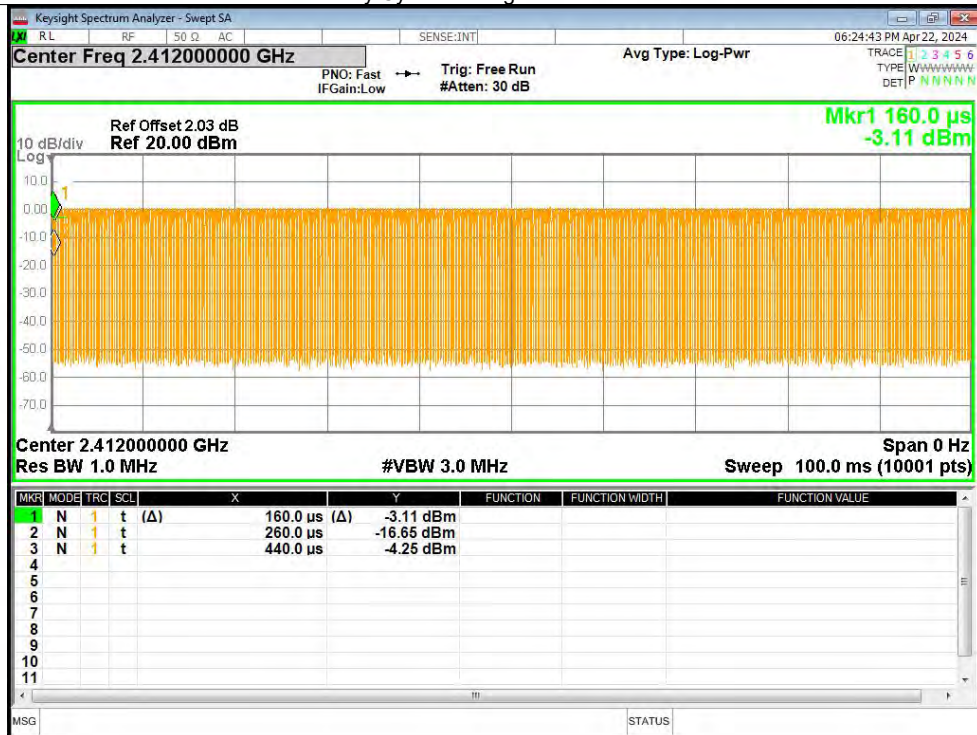



Duty Cycle NVNT g 2437MHz Ant1

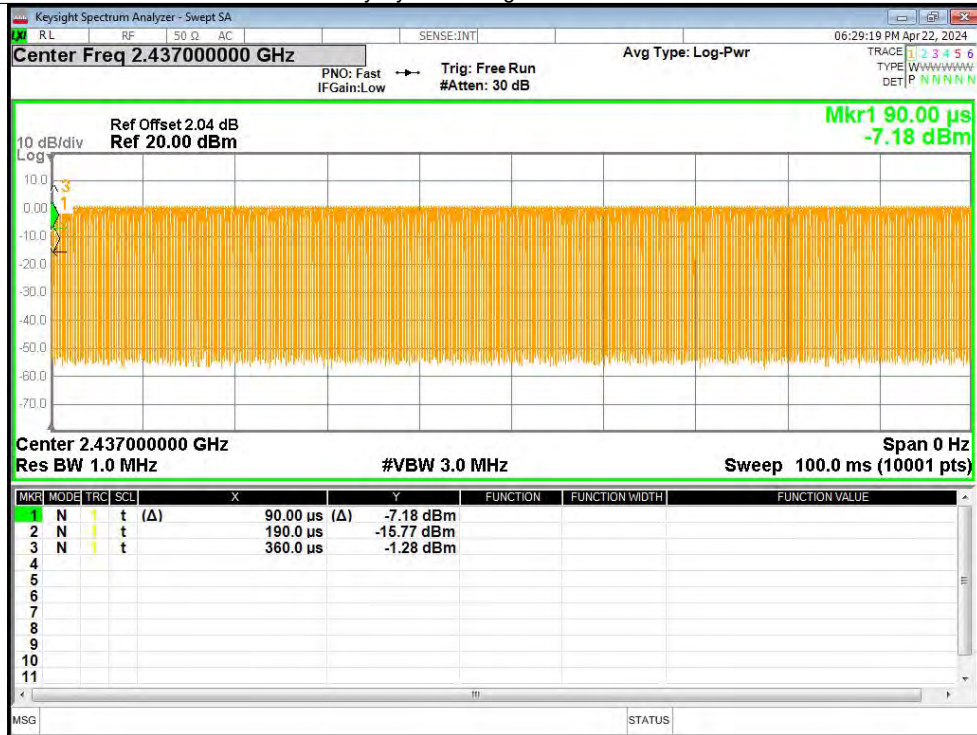

Duty Cycle NVNT g 2462MHz Ant1

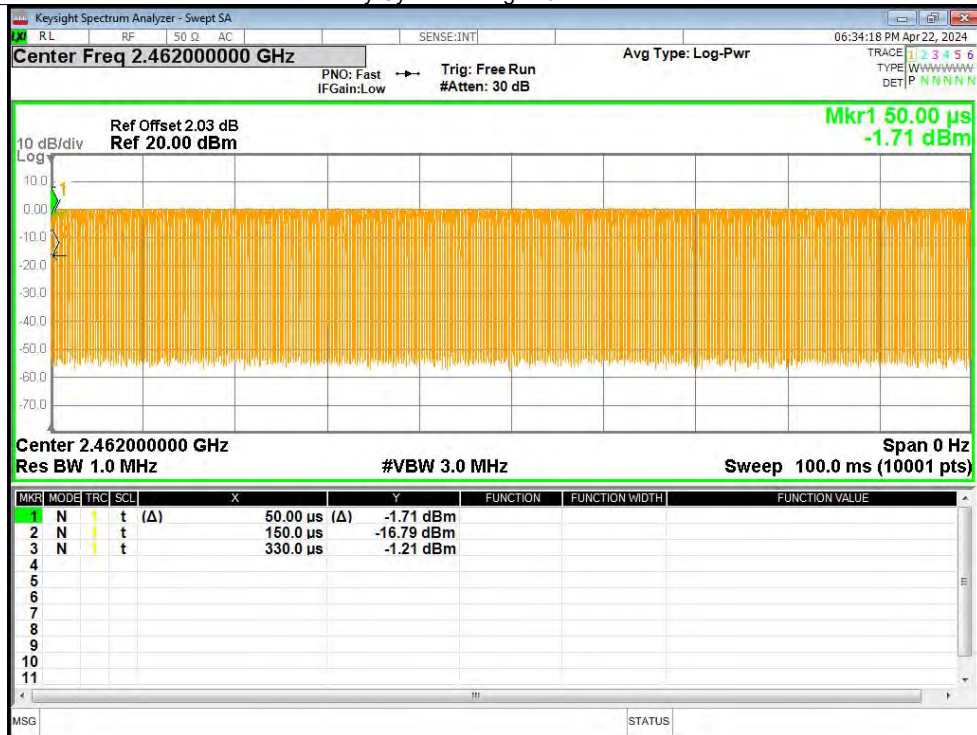

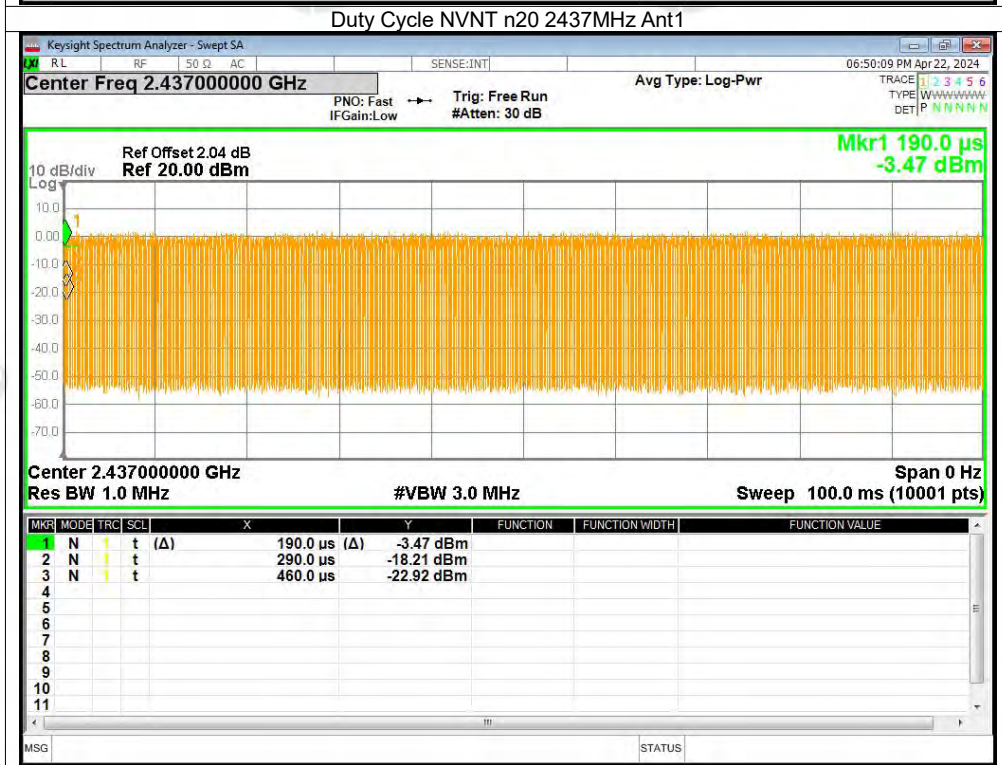
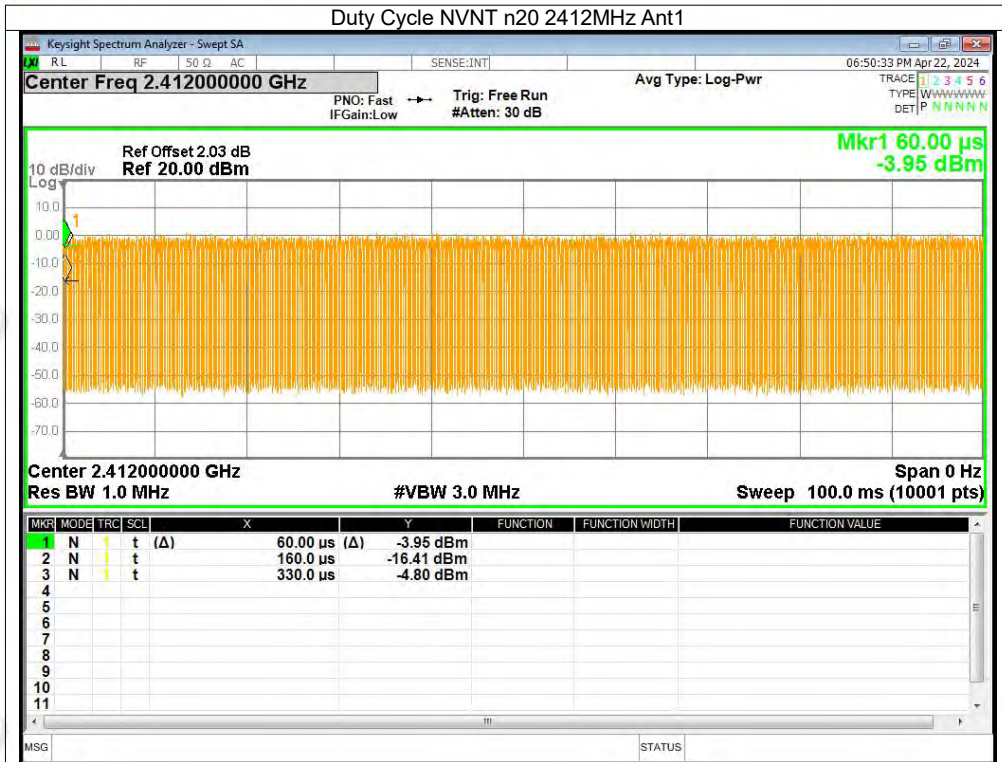

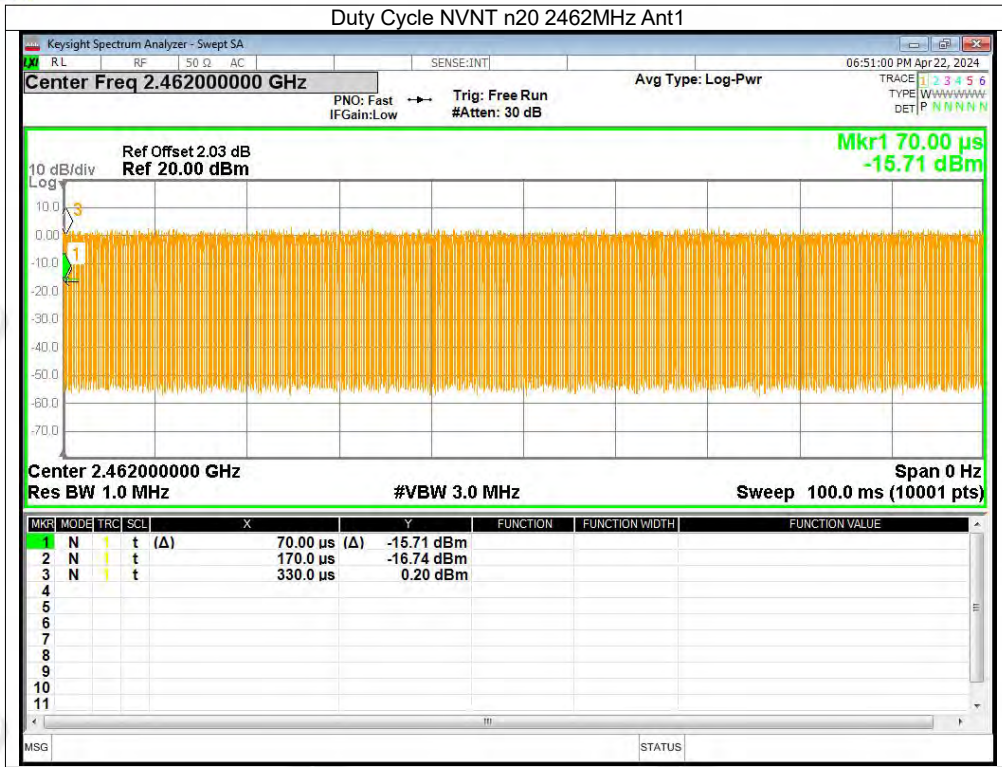



Maximum Average Conducted Output Power

Condition	Mode	Frequency (MHz)	Antenna	Conducted Power (dBm)	Duty Factor (dB)	Total Power (dBm)	Limit (dBm)	Verdict
NVNT	b	2412	Ant1	6.61	0	6.61	30	Pass
NVNT	b	2437	Ant1	6.95	0	6.95	30	Pass
NVNT	b	2462	Ant1	7.2	0	7.2	30	Pass
NVNT	g	2412	Ant1	1.25	1.92	3.17	30	Pass
NVNT	g	2437	Ant1	1.62	2.01	3.63	30	Pass
NVNT	g	2462	Ant1	1.77	1.92	3.69	30	Pass
NVNT	n20	2412	Ant1	3.9	2.11	6.01	30	Pass
NVNT	n20	2437	Ant1	0.97	2.11	3.08	30	Pass
NVNT	n20	2462	Ant1	1.49	2.11	3.6	30	Pass

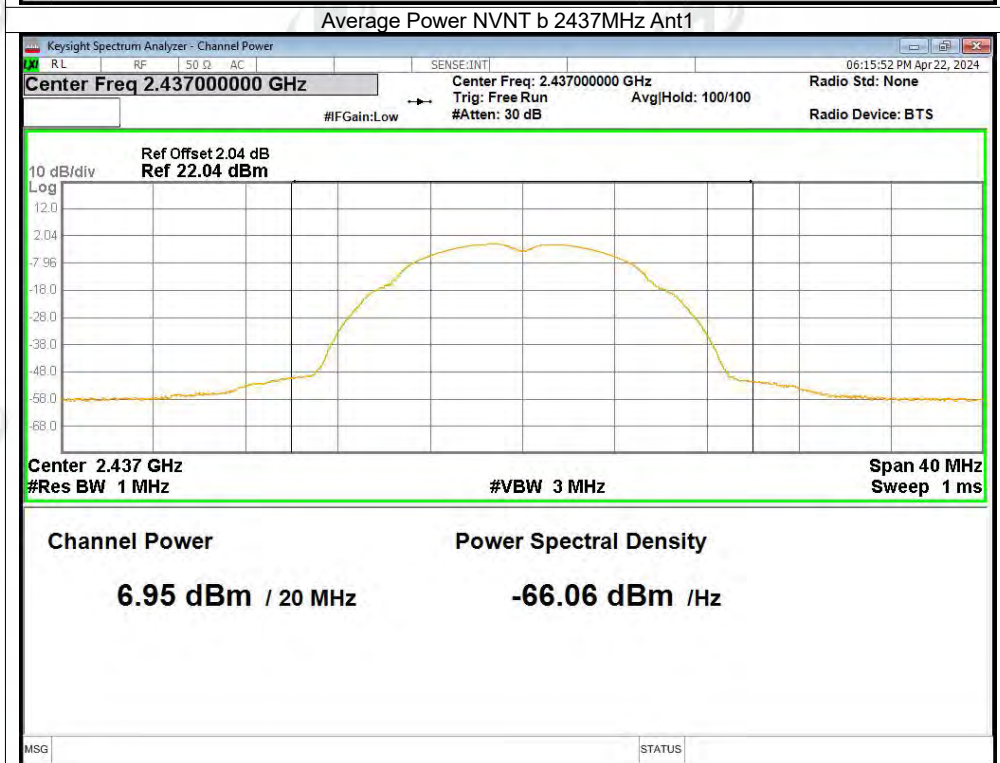
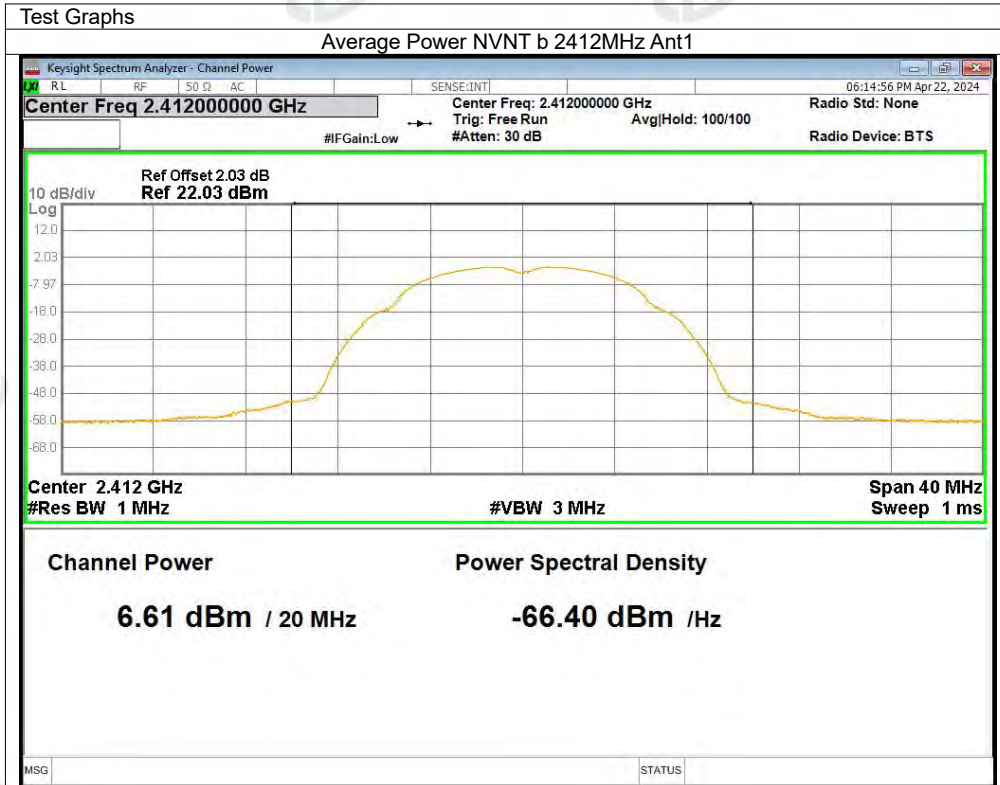

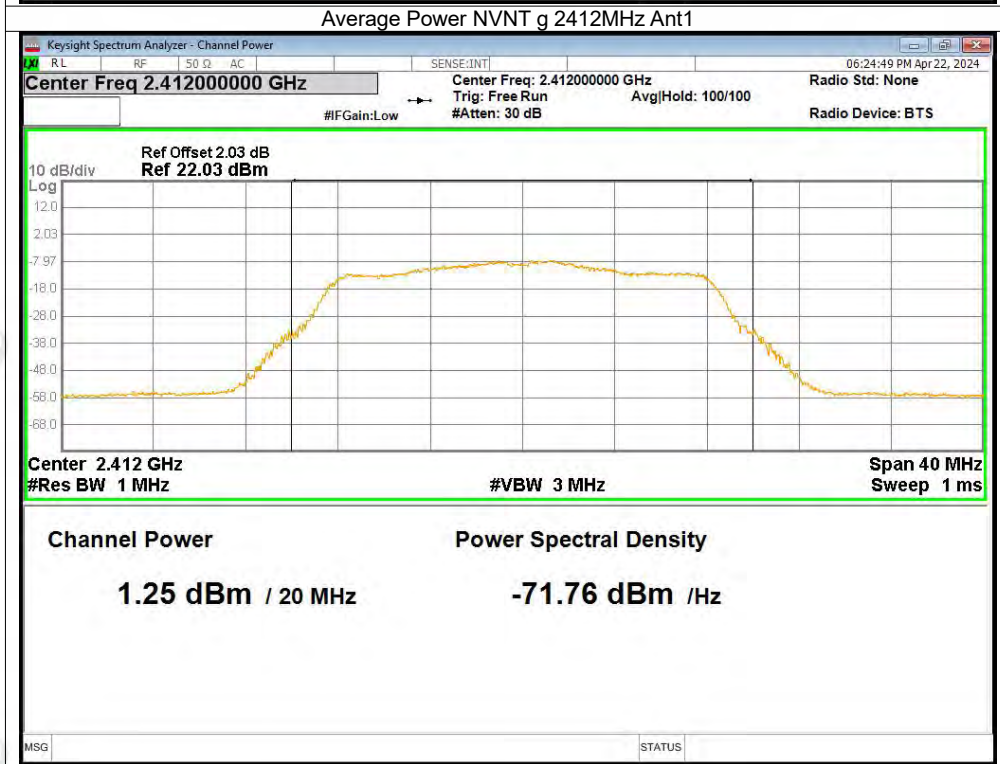
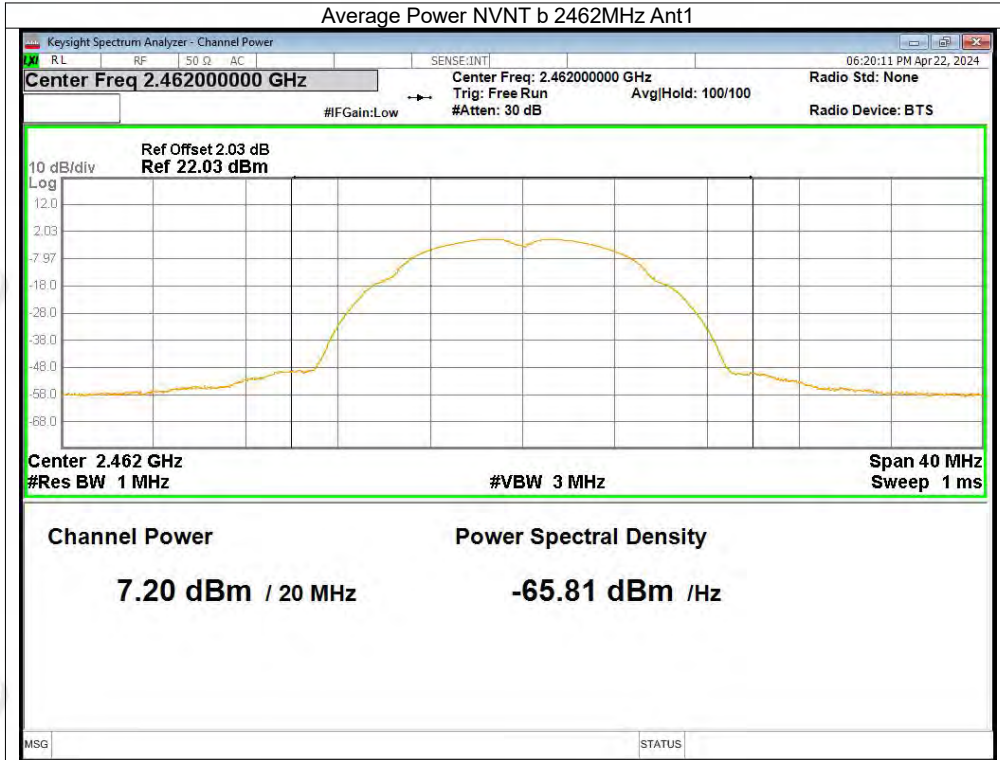



Average Power NVNT g 2437MHz Ant1

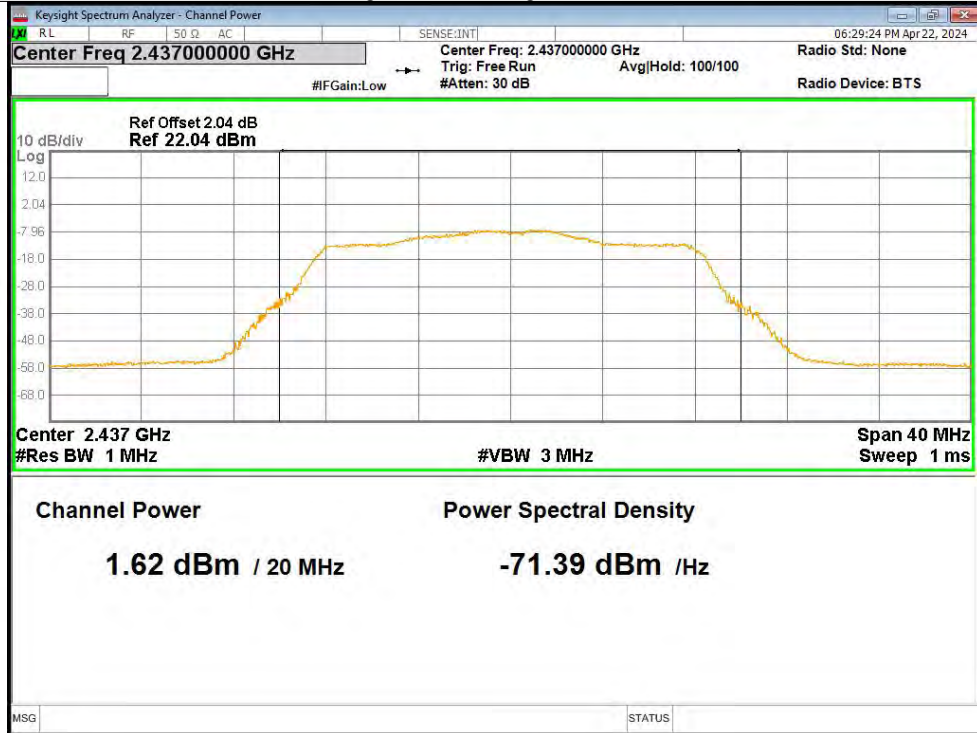

Average Power NVNT g 2462MHz Ant1

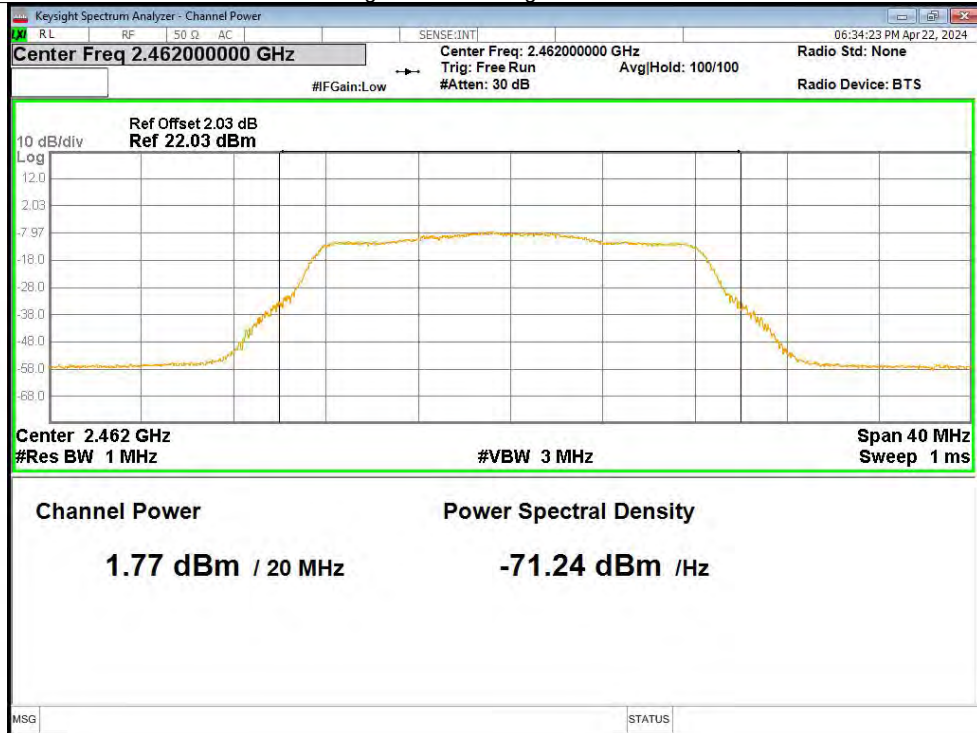



Average Power NVNT n20 2412MHz Ant1

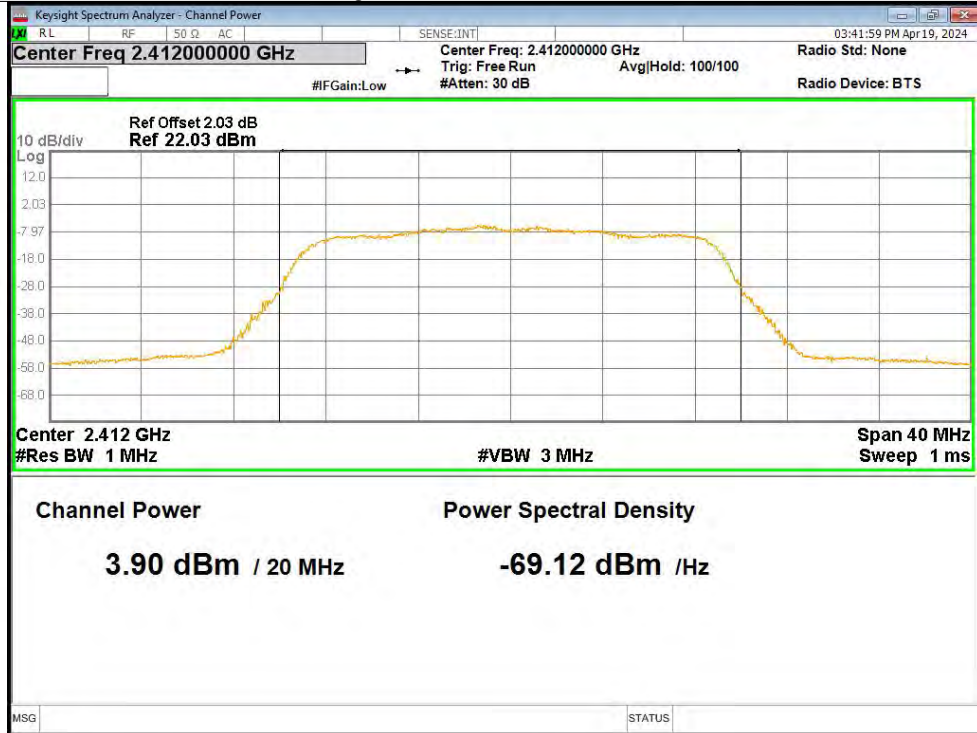

Average Power NVNT n20 2437MHz Ant1

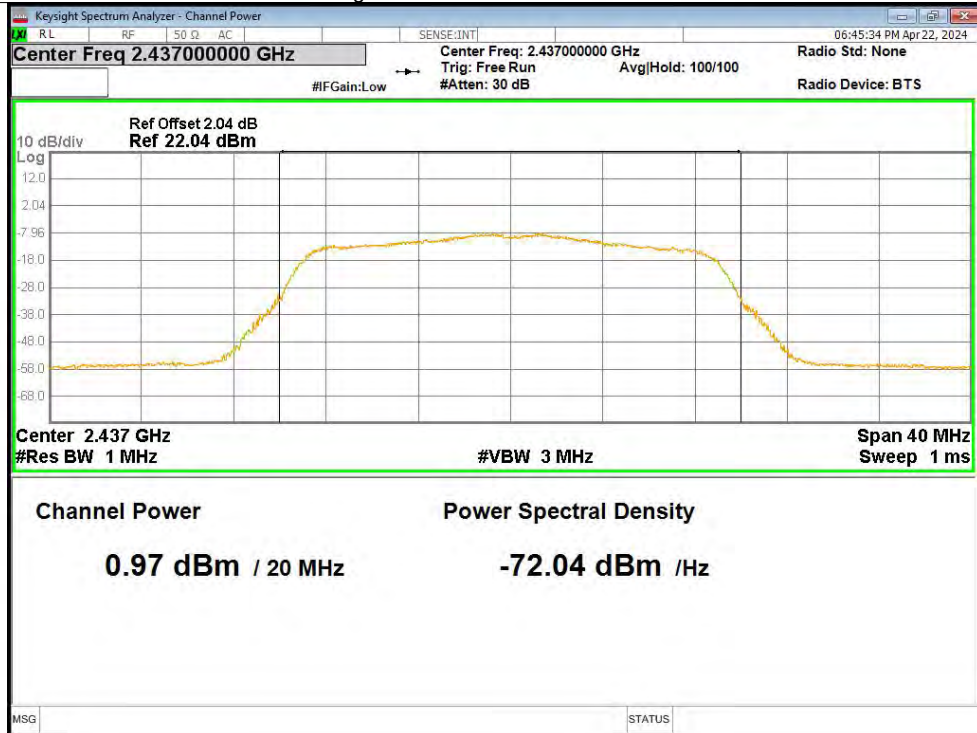

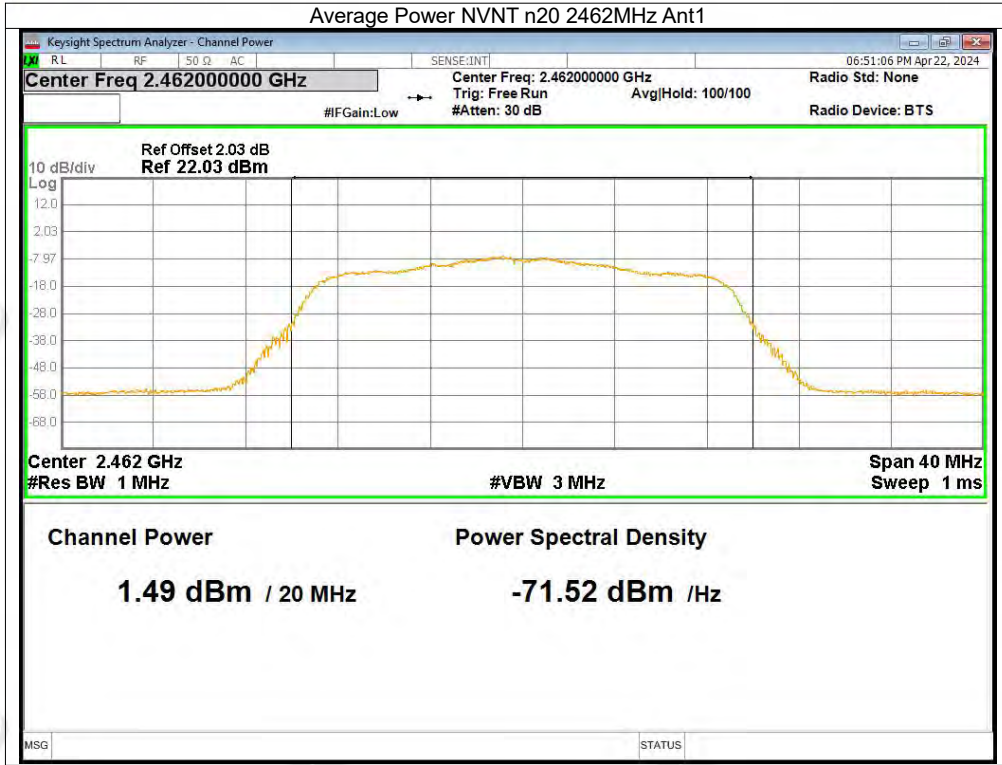



Maximum Peak Conducted Output Power

Condition	Mode	Frequency (MHz)	Antenna	Conducted Power (dBm)	Total Power (dBm)	Limit (dBm)	Verdict
NVNT	b	2412	Ant1	8.2	8.2	30	Pass
NVNT	b	2437	Ant1	8.41	8.41	30	Pass
NVNT	b	2462	Ant1	8.42	8.42	30	Pass
NVNT	g	2412	Ant1	7.8	7.8	30	Pass
NVNT	g	2437	Ant1	8.15	8.15	30	Pass
NVNT	g	2462	Ant1	8.37	8.37	30	Pass
NVNT	n20	2412	Ant1	7.45	7.45	30	Pass
NVNT	n20	2437	Ant1	7.71	7.71	30	Pass
NVNT	n20	2462	Ant1	8.17	8.17	30	Pass



Condition	Mode	Frequency (MHz)	Antenna	-6 dB Bandwidth (MHz)	Limit -6 dB Bandwidth (MHz)	Verdict
NVNT	b	2412	Ant1	7.905	0.5	Pass
NVNT	b	2437	Ant1	8.431	0.5	Pass
NVNT	b	2462	Ant1	8.249	0.5	Pass
NVNT	g	2412	Ant1	15.287	0.5	Pass
NVNT	g	2437	Ant1	15.732	0.5	Pass
NVNT	g	2462	Ant1	15.705	0.5	Pass
NVNT	n20	2412	Ant1	17.606	0.5	Pass
NVNT	n20	2437	Ant1	15.155	0.5	Pass
NVNT	n20	2462	Ant1	17.607	0.5	Pass



Test Graphs

-6dB Bandwidth NVNT b 2412MHz Ant1

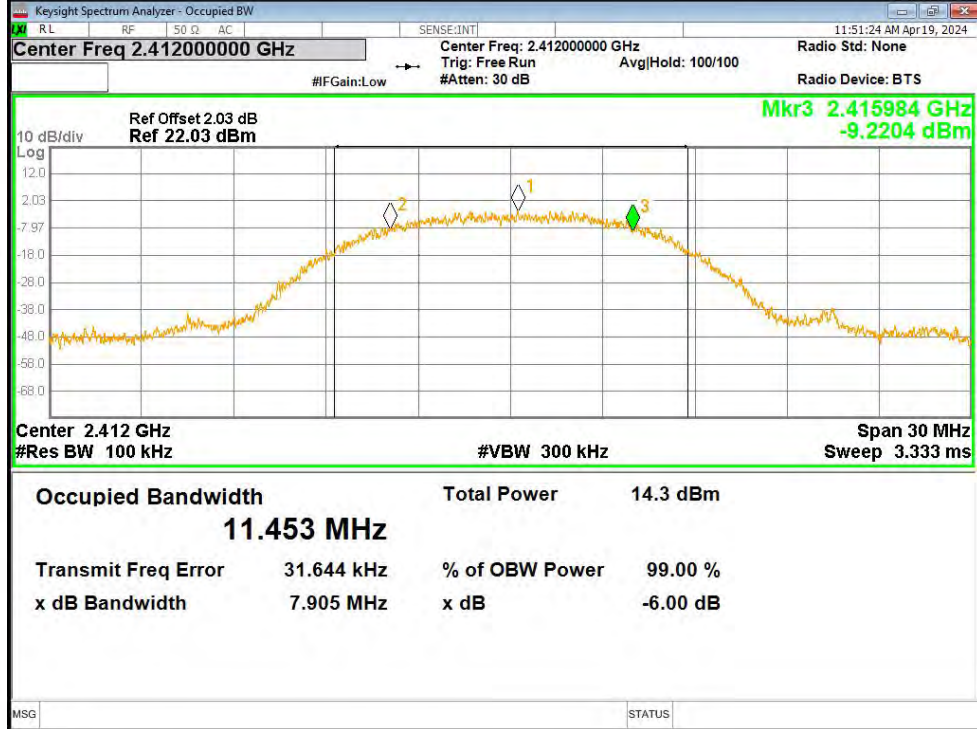

-6dB Bandwidth NVNT b 2437MHz Ant1

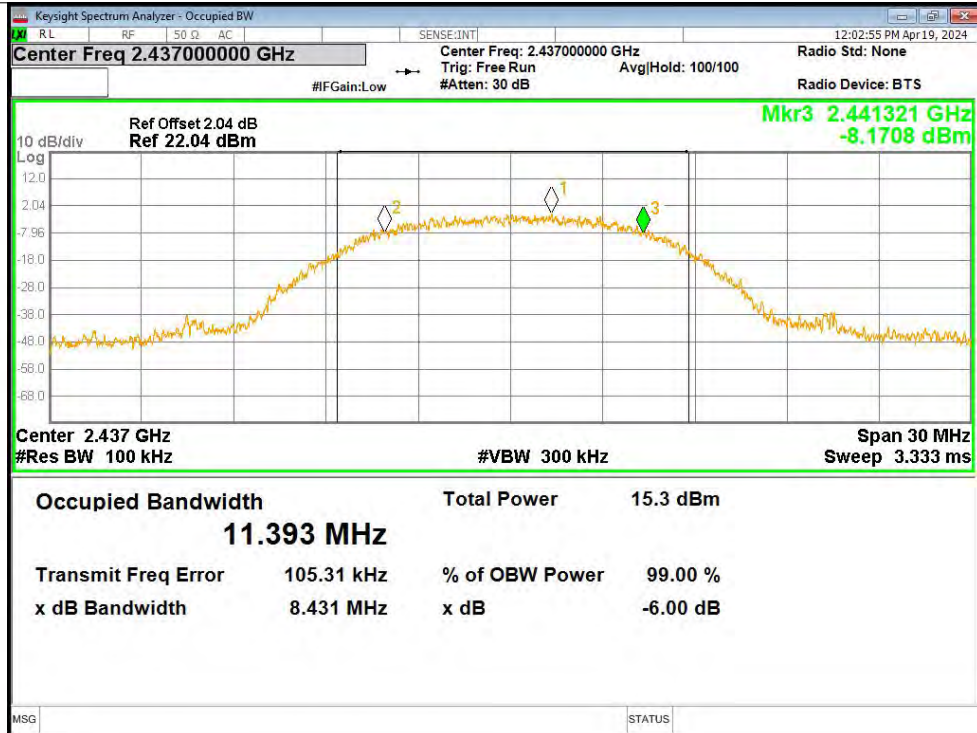



-6dB Bandwidth NVNT b 2462MHz Ant1

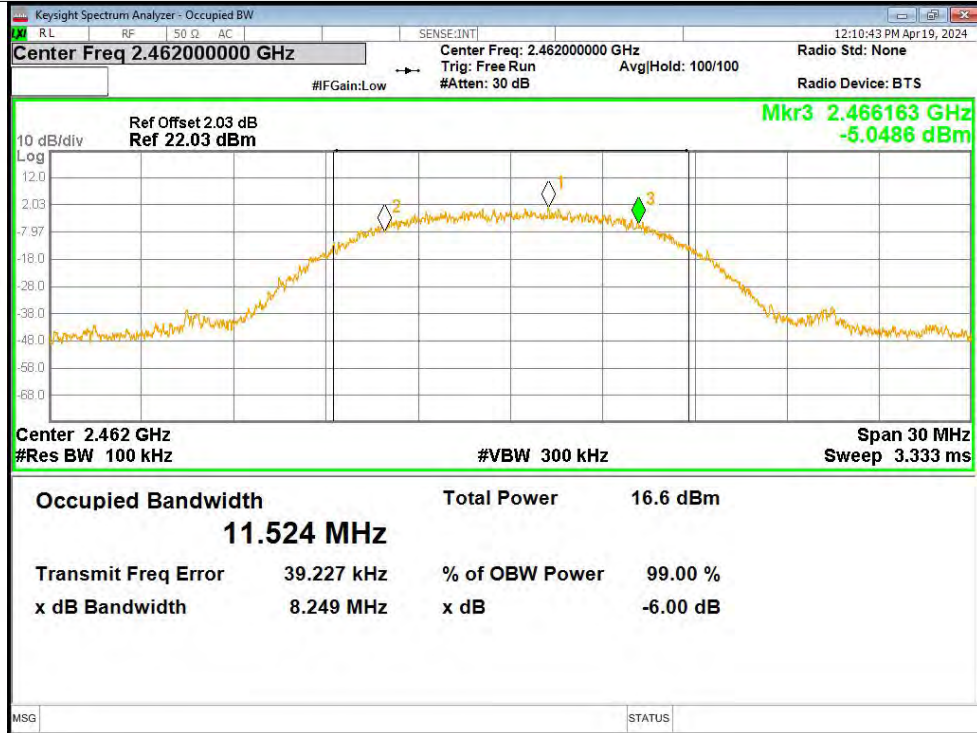

-6dB Bandwidth NVNT g 2412MHz Ant1

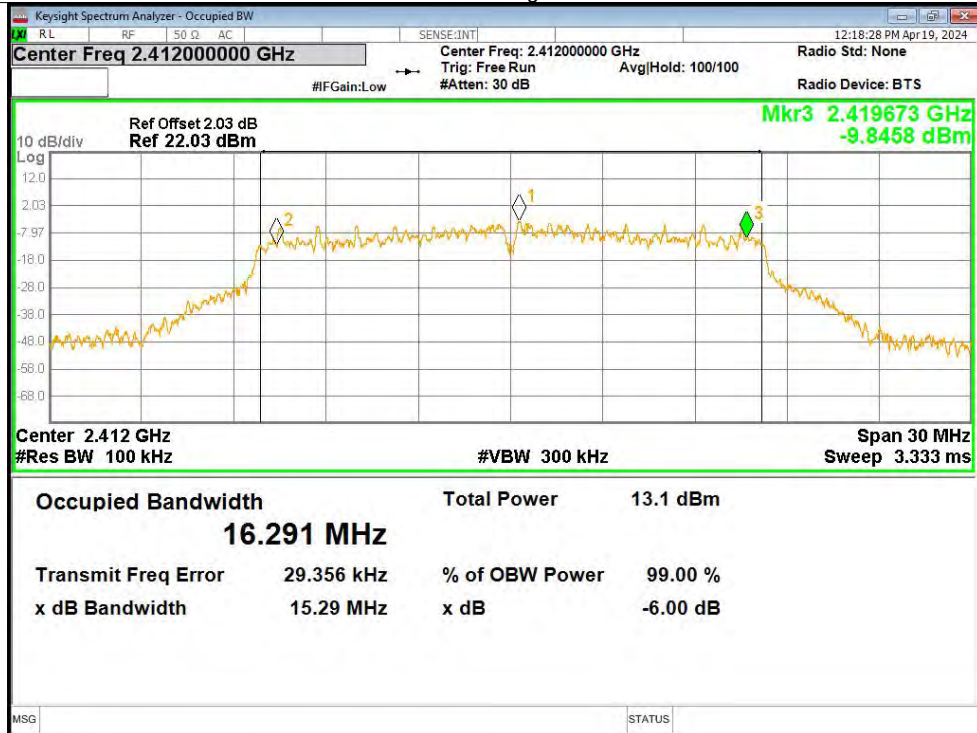



-6dB Bandwidth NVNT g 2437MHz Ant1

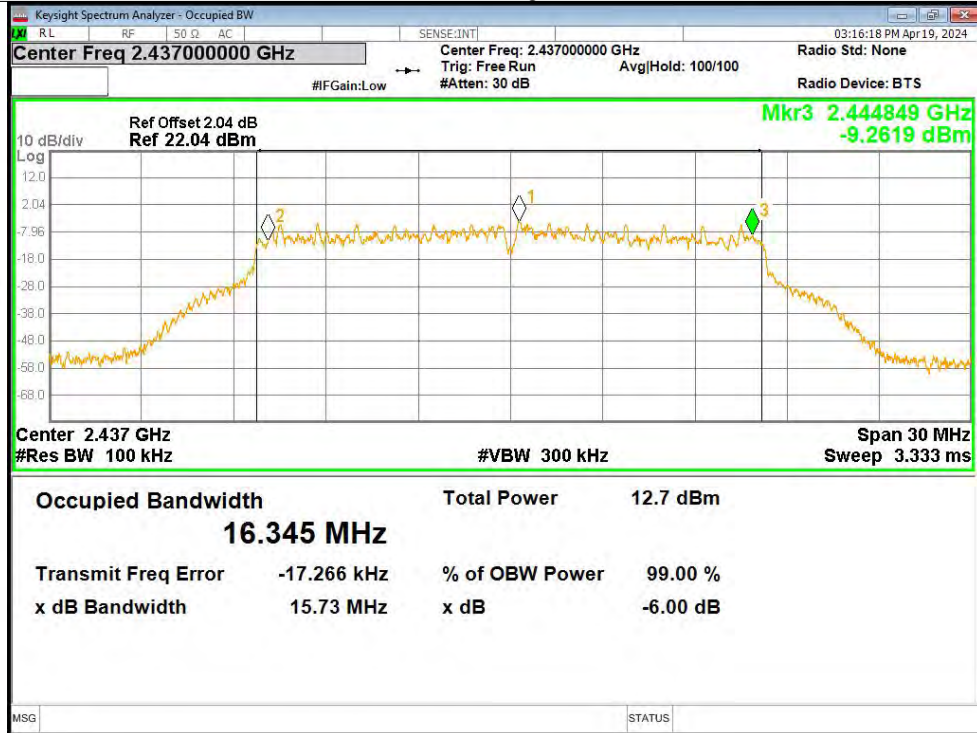

-6dB Bandwidth NVNT g 2462MHz Ant1

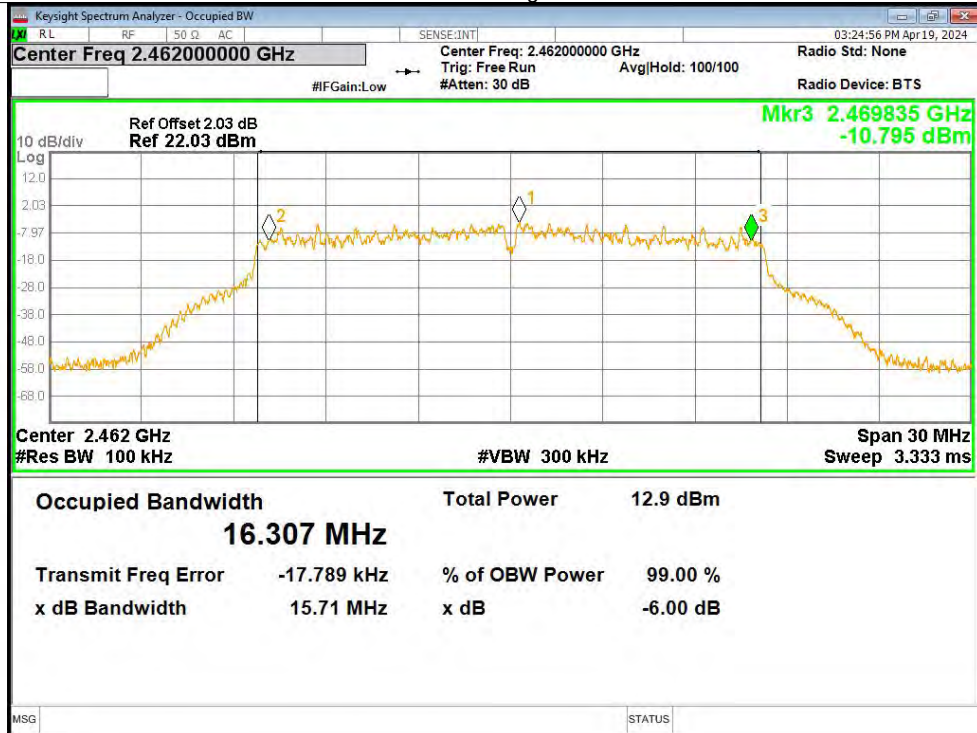



-6dB Bandwidth NVNT n20 2412MHz Ant1

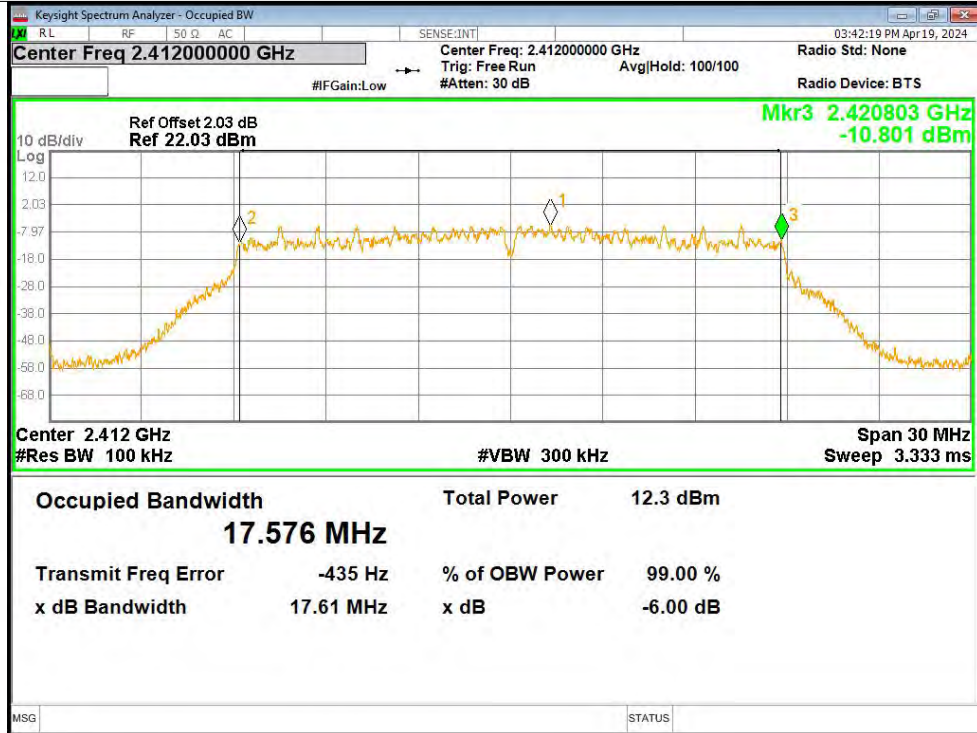

-6dB Bandwidth NVNT n20 2437MHz Ant1

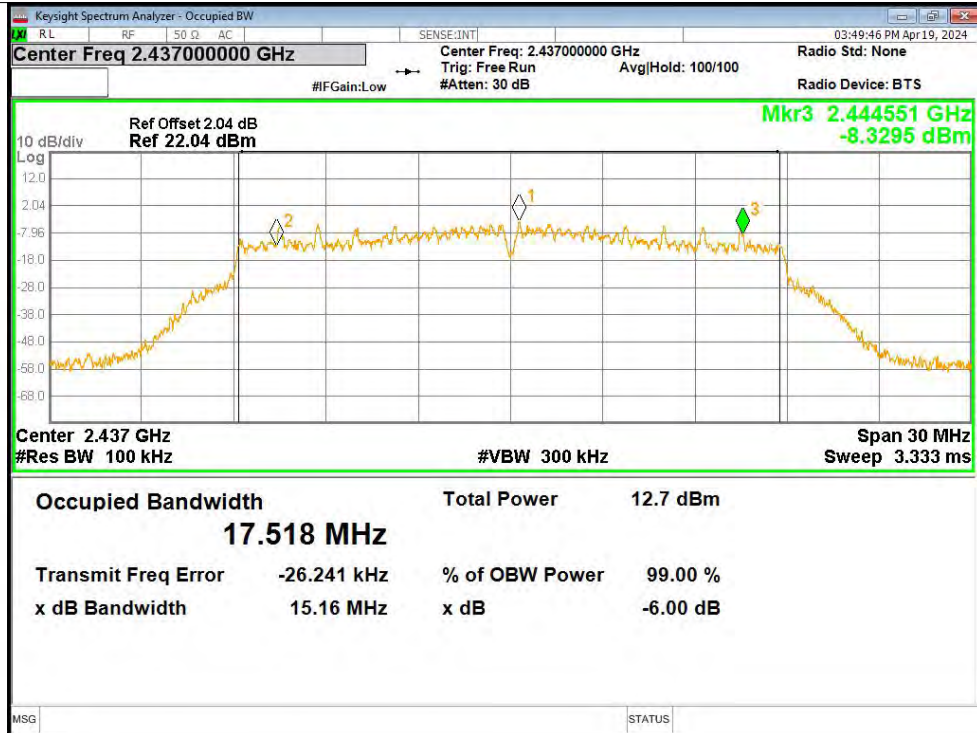

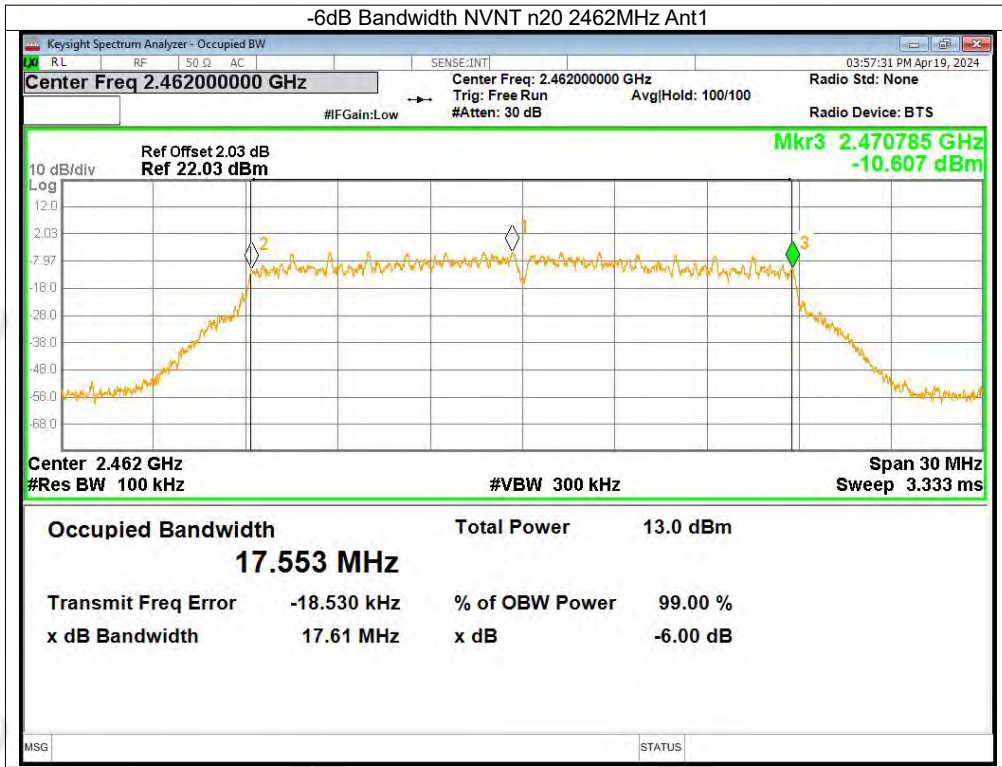



Occupied Channel Bandwidth

Condition	Mode	Frequency (MHz)	Antenna	99% OBW (MHz)
NVNT	b	2412	Ant1	11.431
NVNT	b	2437	Ant1	11.576
NVNT	b	2462	Ant1	11.533
NVNT	g	2412	Ant1	16.329
NVNT	g	2437	Ant1	16.402
NVNT	g	2462	Ant1	16.319
NVNT	n20	2412	Ant1	17.581
NVNT	n20	2437	Ant1	17.522
NVNT	n20	2462	Ant1	17.577

Test Graphs
OBW NVNT b 2412MHz Ant1

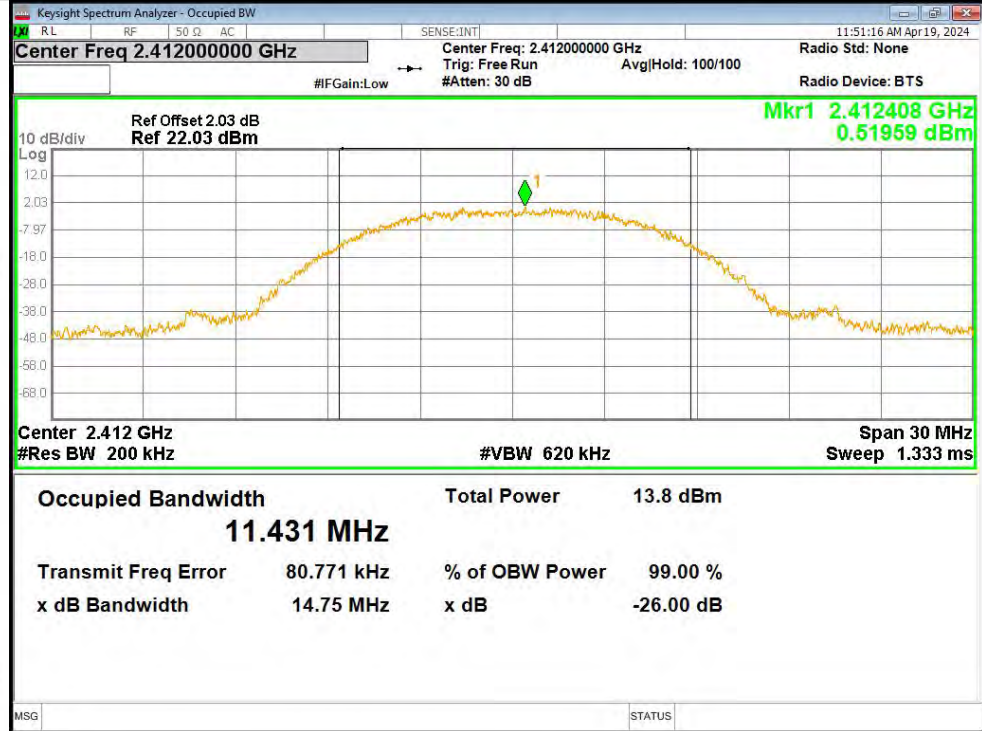

OBW NVNT b 2437MHz Ant1

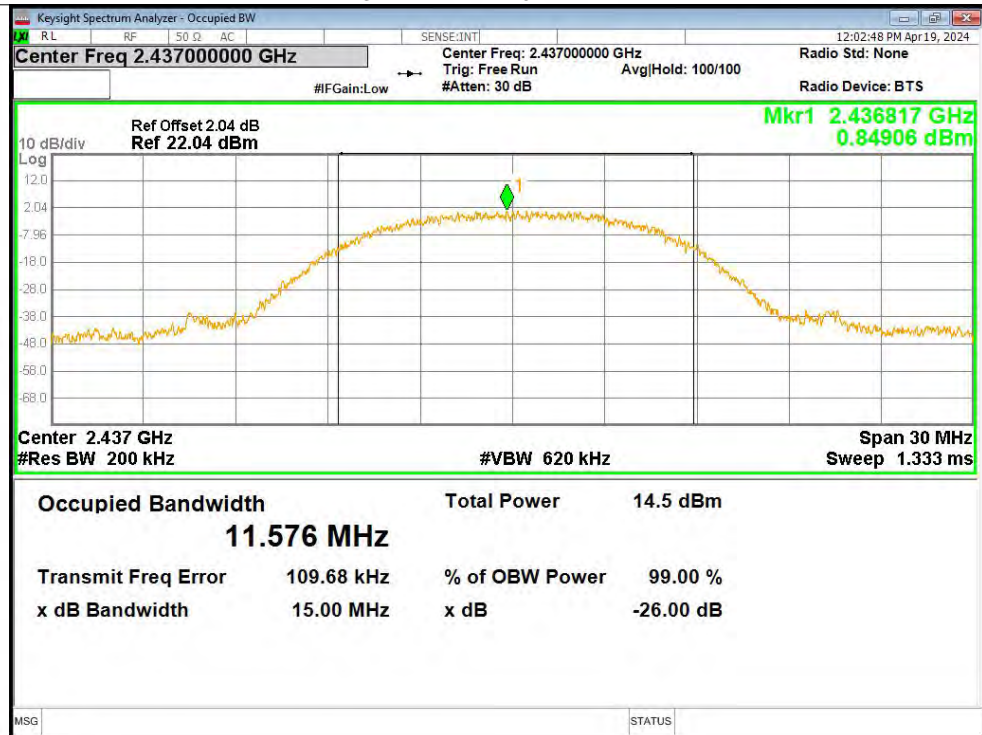



OBW NVNT b 2462MHz Ant1

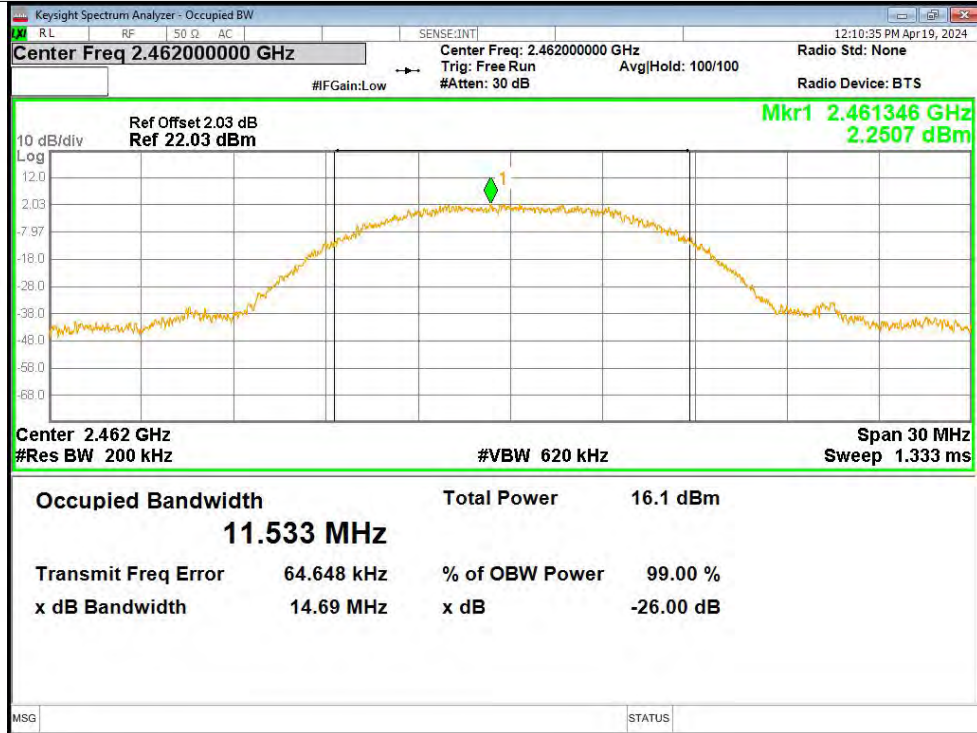

OBW NVNT g 2412MHz Ant1

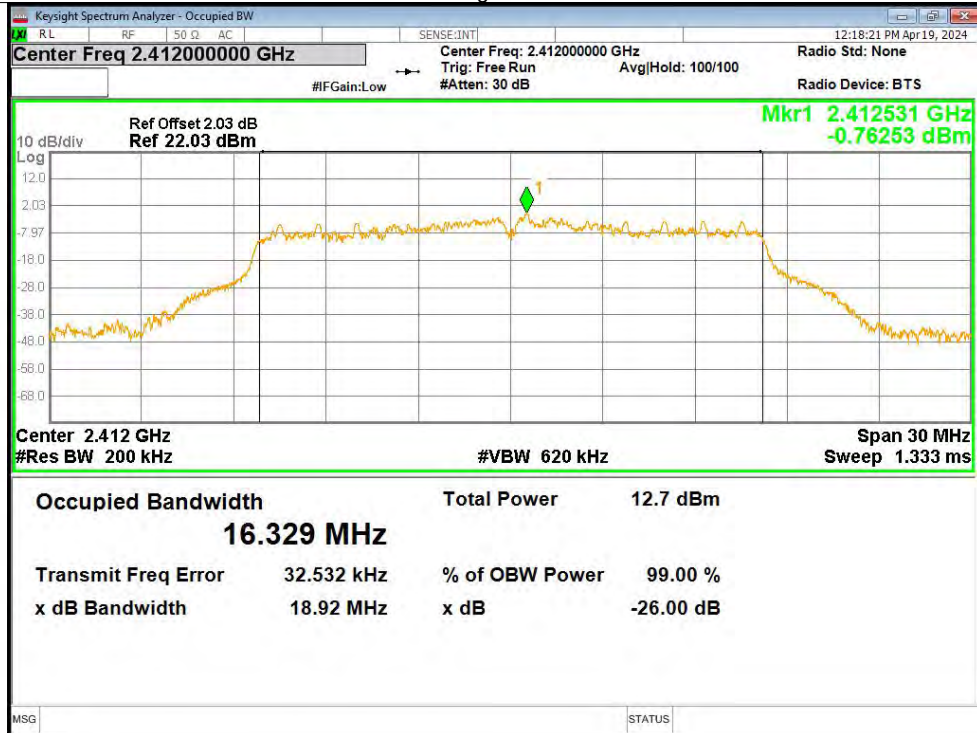



OBW NVNT g 2437MHz Ant1

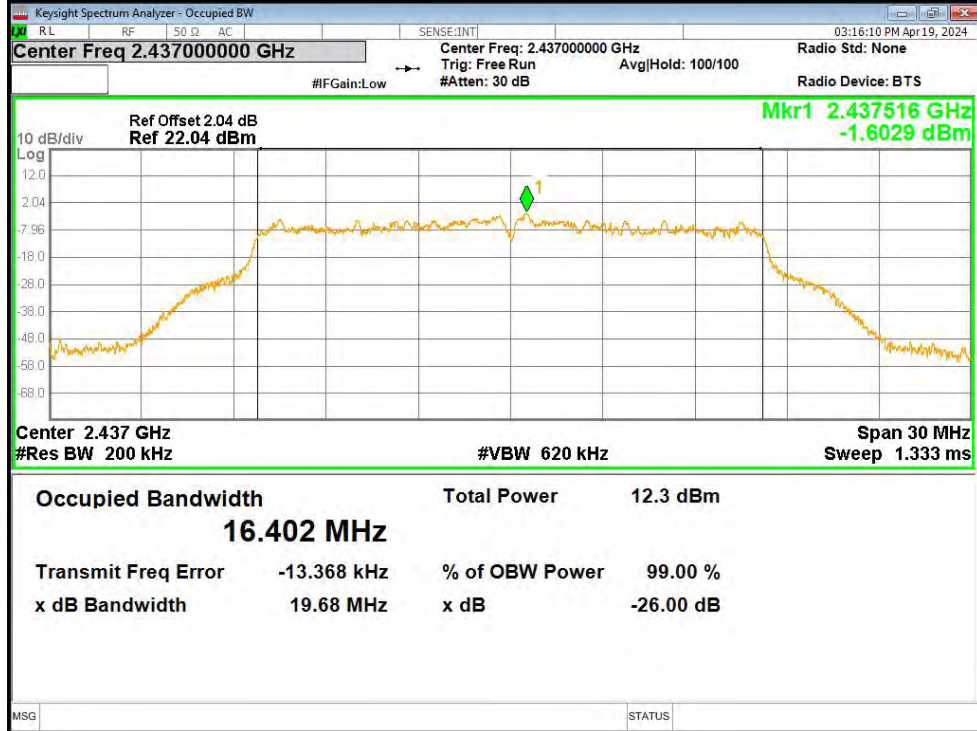

OBW NVNT g 2462MHz Ant1

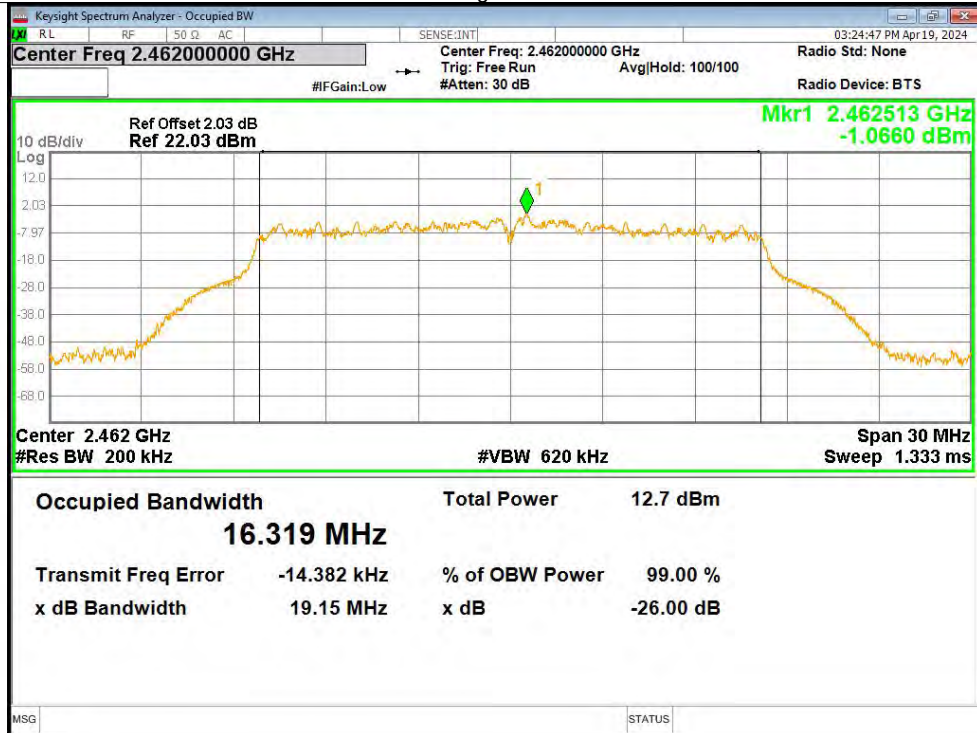

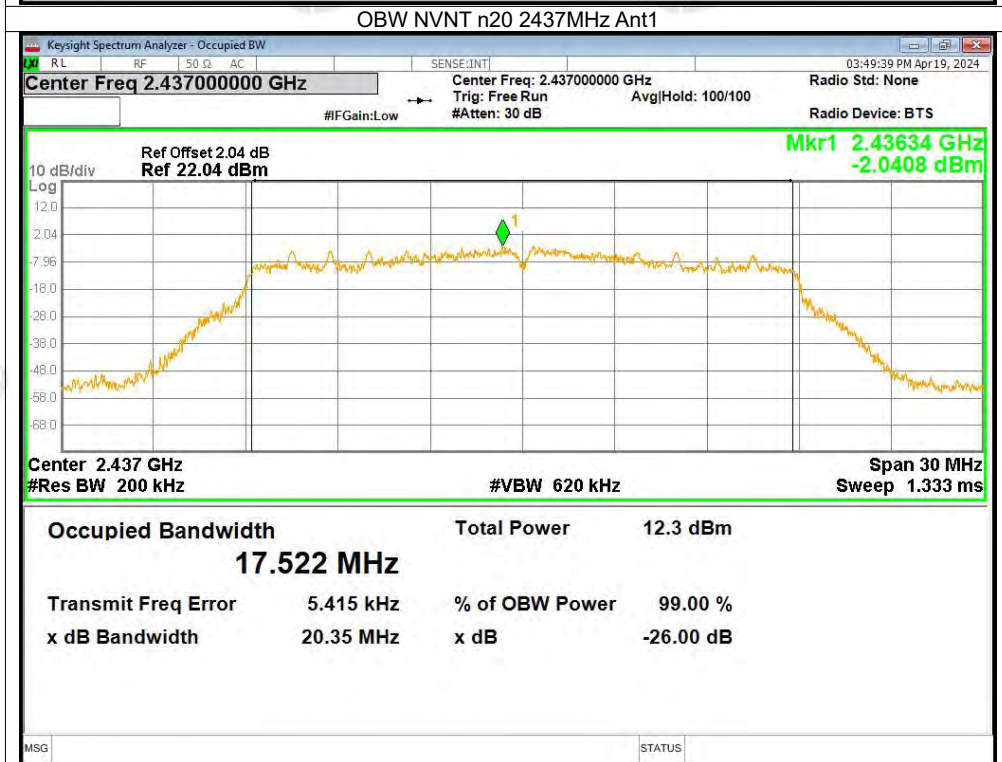
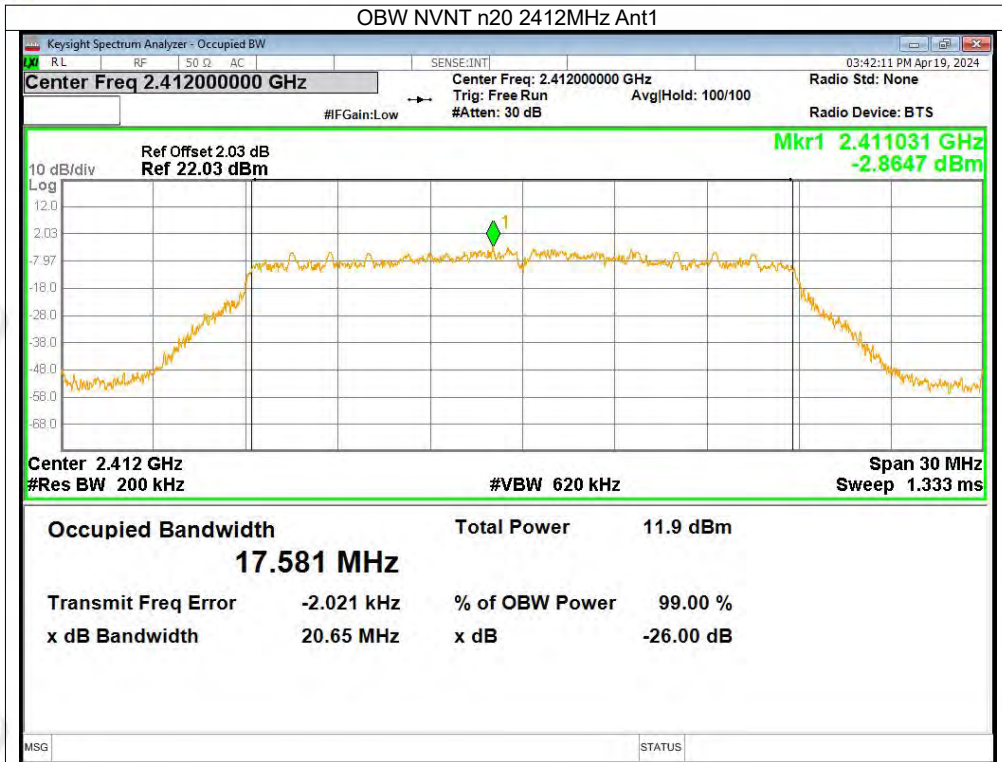

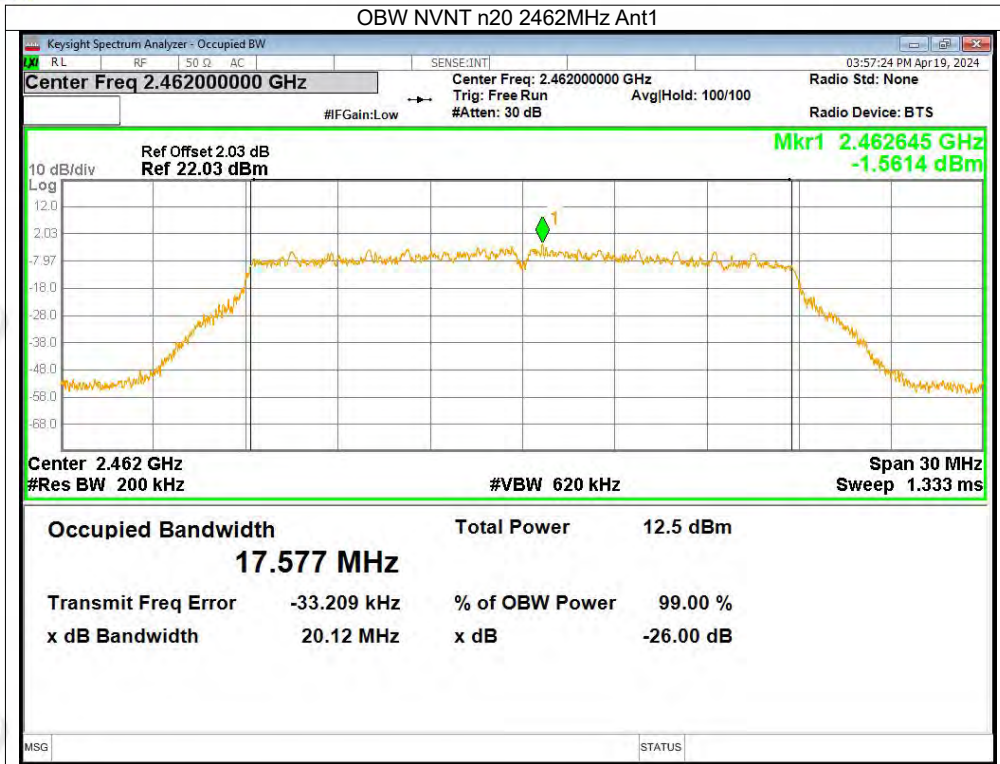



Maximum Power Spectral Density Level

Condition	Mode	Frequency (MHz)	Antenna	Conducted PSD (dBm/3kHz)	Total PSD (dBm/3kHz)	Limit (dBm/3kHz)	Verdict
NVNT	b	2412	Ant1	-15.11	-15.11	8	Pass
NVNT	b	2437	Ant1	-13.73	-13.73	8	Pass
NVNT	b	2462	Ant1	-11.92	-11.92	8	Pass
NVNT	g	2412	Ant1	-12.95	-12.95	8	Pass
NVNT	g	2437	Ant1	-19.59	-19.59	8	Pass
NVNT	g	2462	Ant1	-18.7	-18.7	8	Pass
NVNT	n20	2412	Ant1	-17.47	-17.47	8	Pass
NVNT	n20	2437	Ant1	-16.89	-16.89	8	Pass
NVNT	n20	2462	Ant1	-17.69	-17.69	8	Pass



Test Graphs

PSD NVNT b 2412MHz Ant1

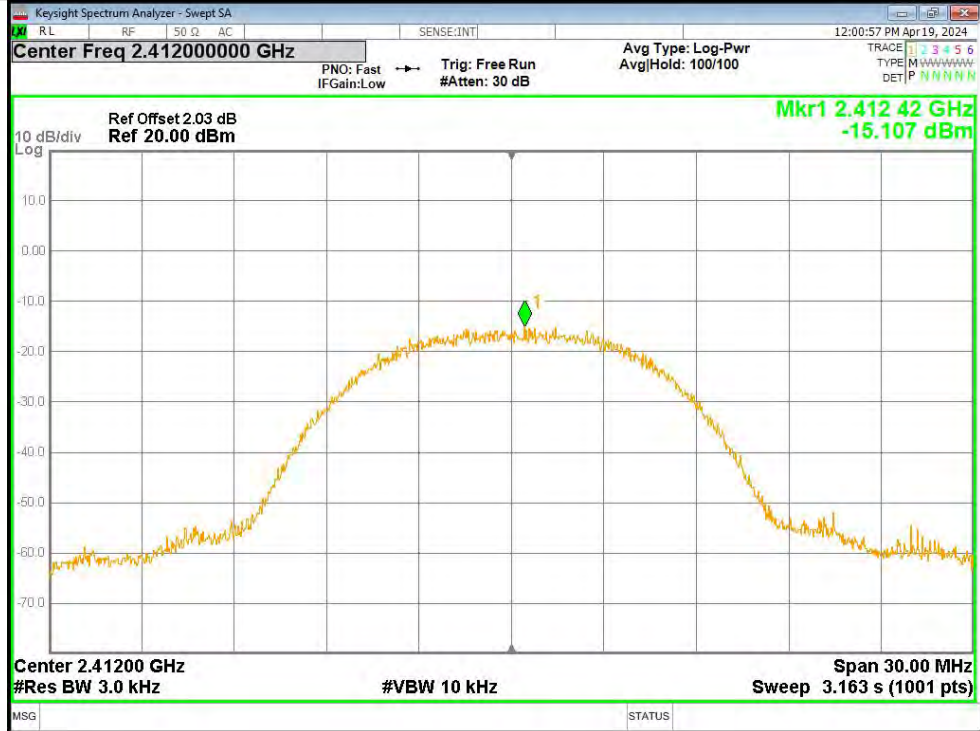

PSD NVNT b 2437MHz Ant1

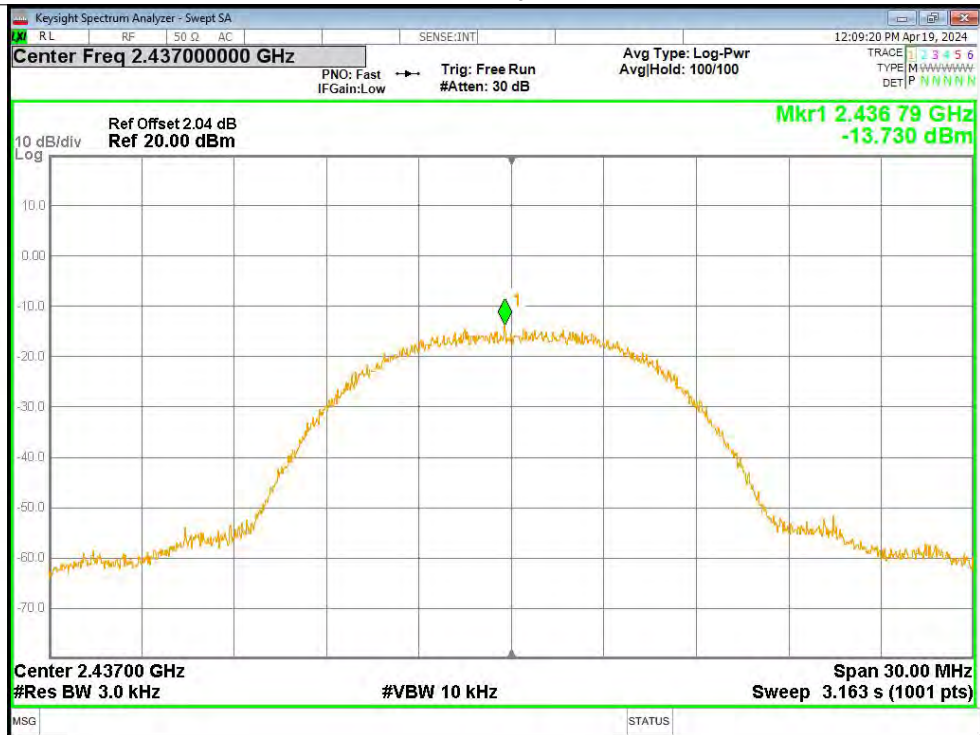

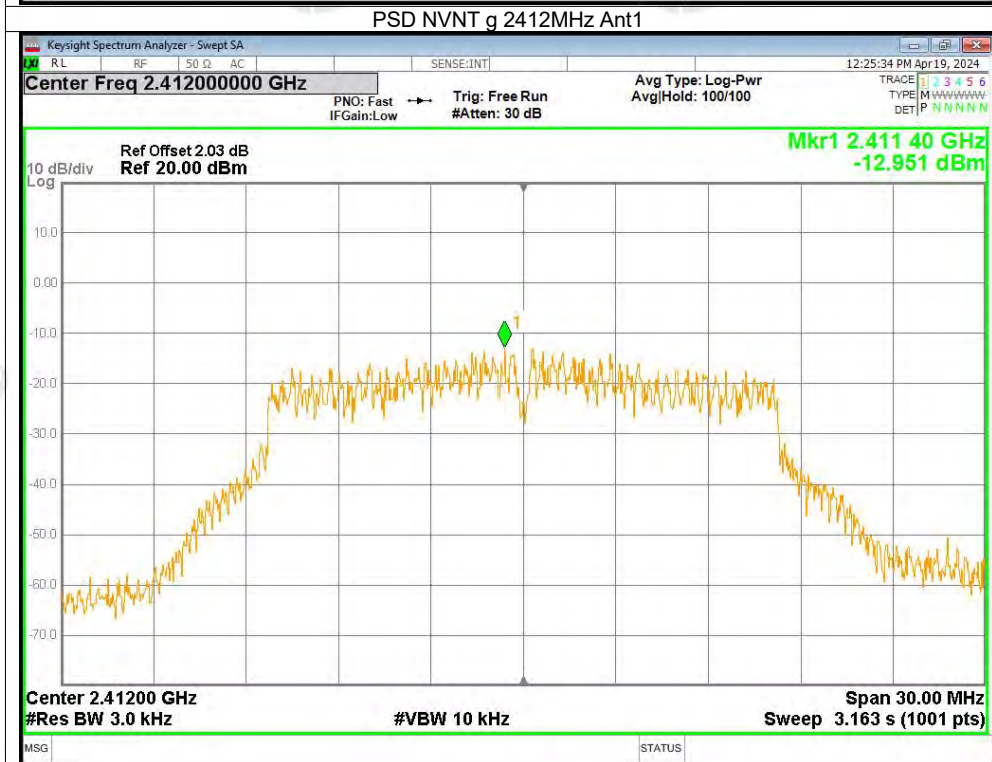
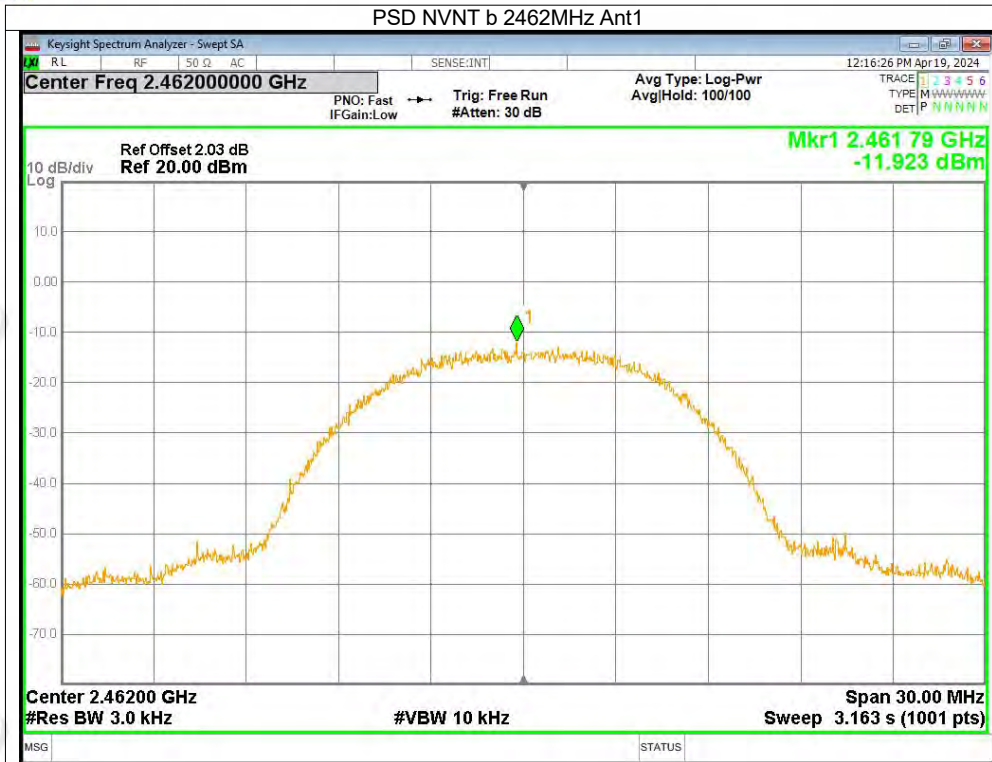

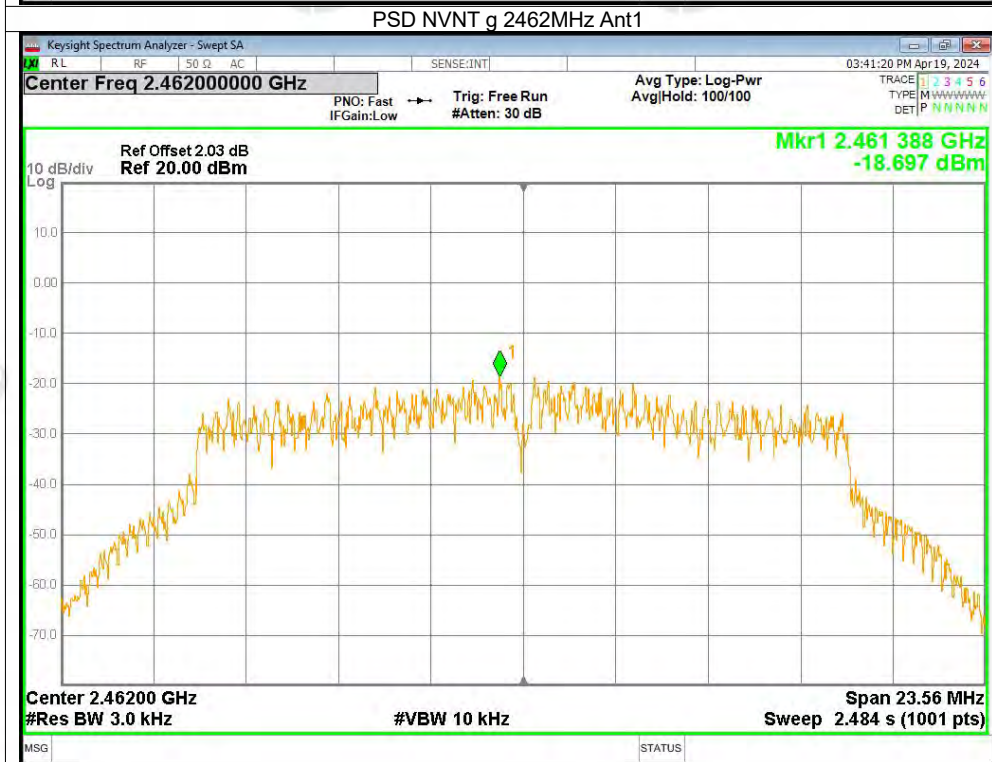
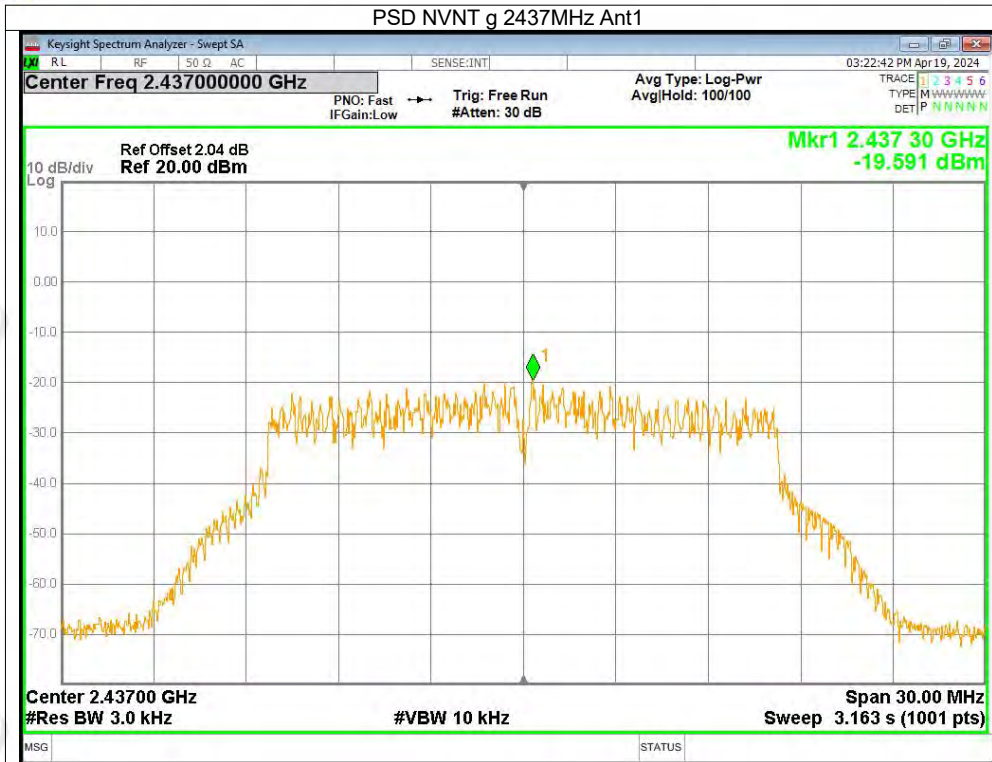

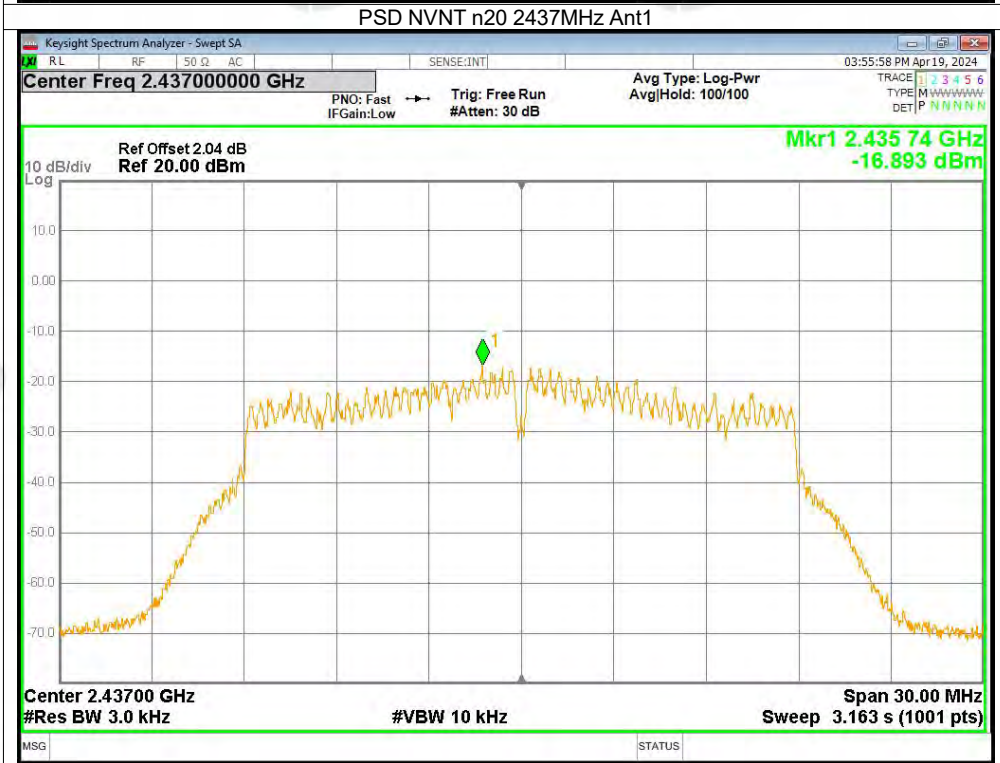
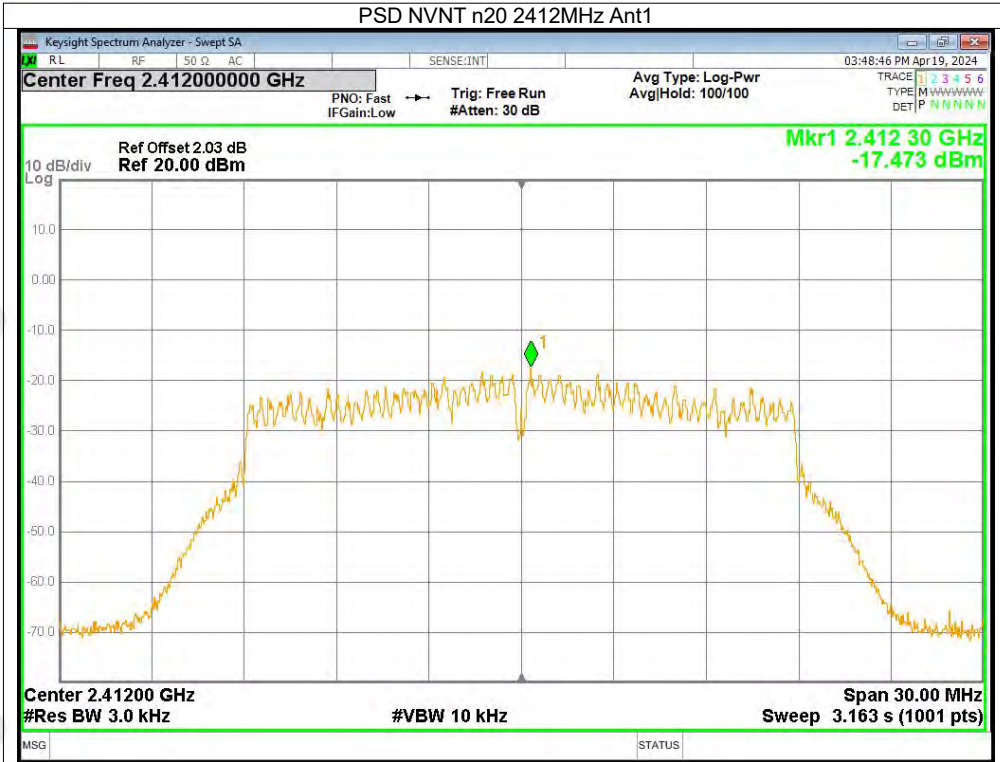

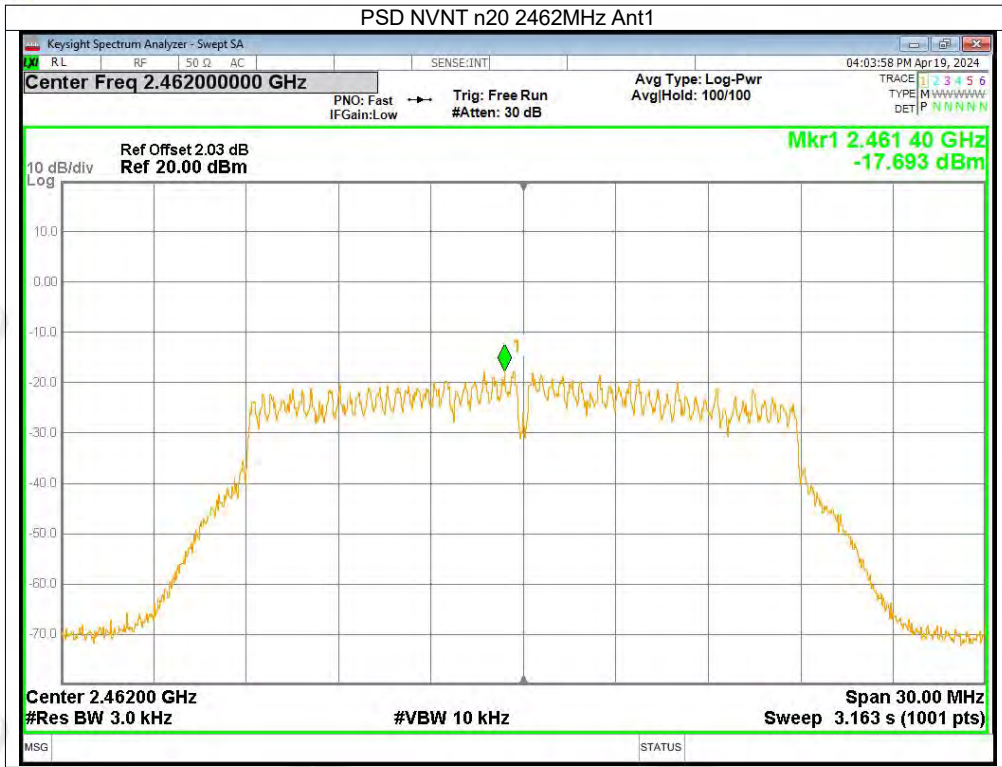



Condition	Mode	Frequency (MHz)	Antenna	Max Value (dBc)	Limit (dBc)	Verdict
NVNT	b	2412	Ant1	-43.95	-30	Pass
NVNT	b	2462	Ant1	-57.49	-30	Pass
NVNT	g	2412	Ant1	-38.05	-30	Pass
NVNT	g	2462	Ant1	-52.58	-30	Pass
NVNT	n20	2412	Ant1	-42.68	-30	Pass
NVNT	n20	2462	Ant1	-51.06	-30	Pass

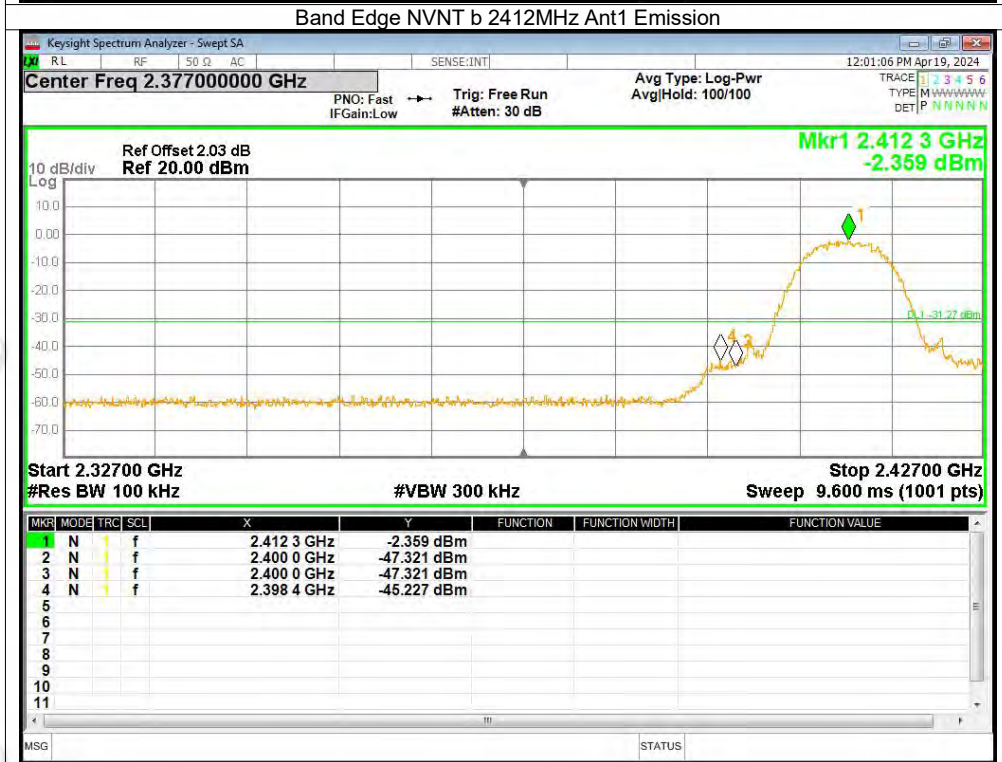
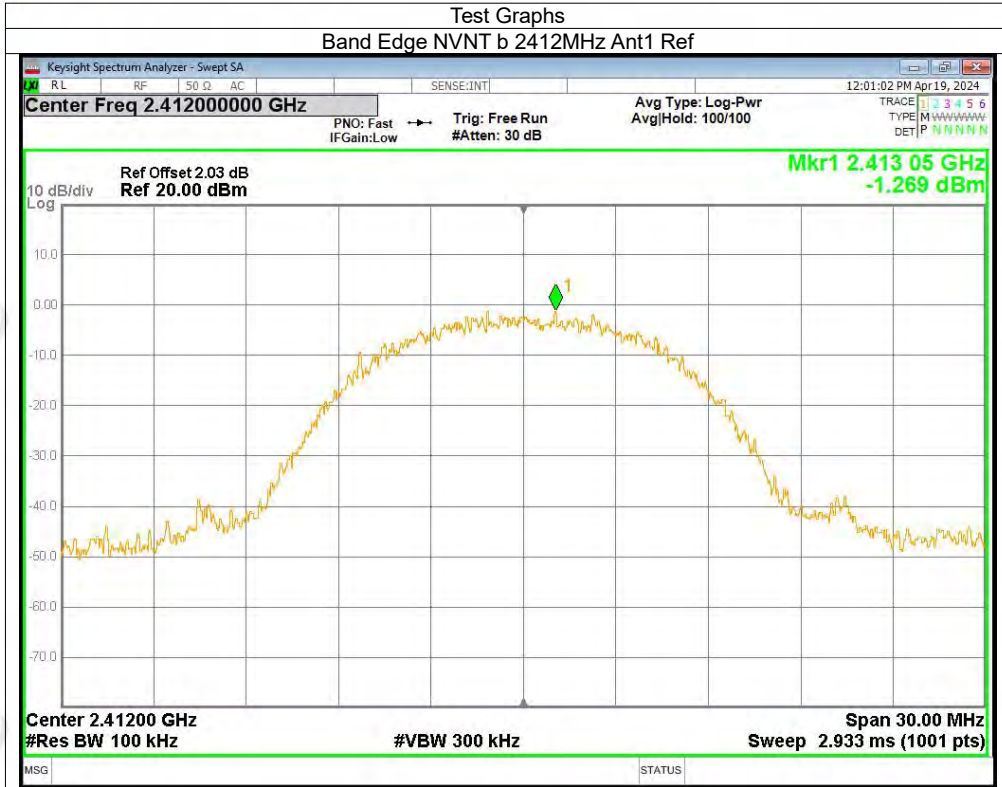



Band Edge NVNT b 2462MHz Ant1 Ref

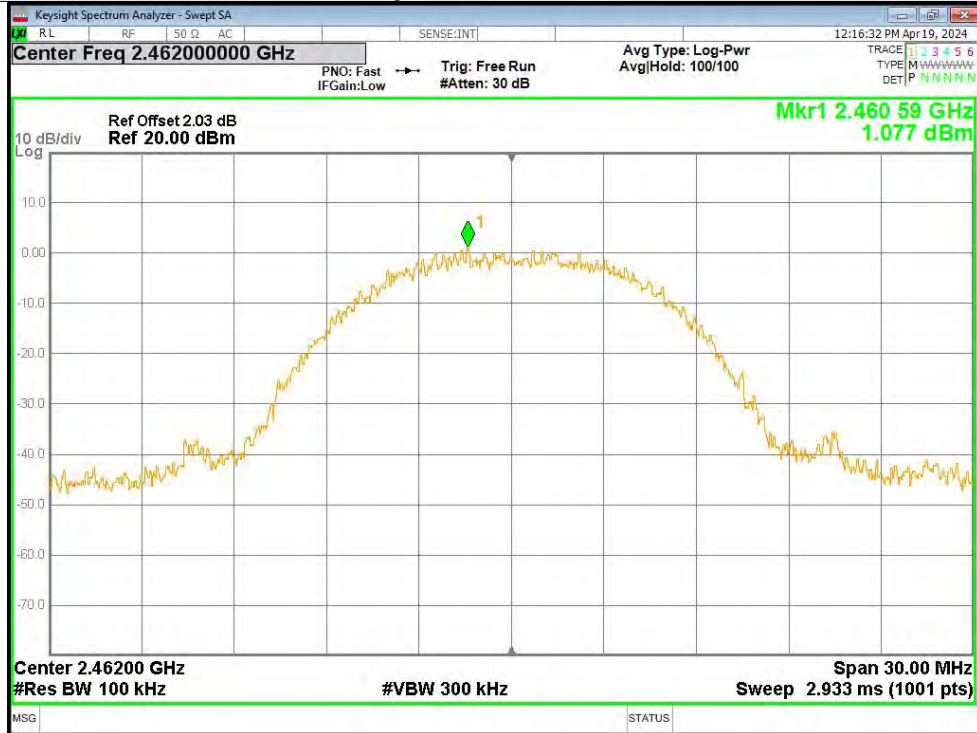

Band Edge NVNT b 2462MHz Ant1 Emission

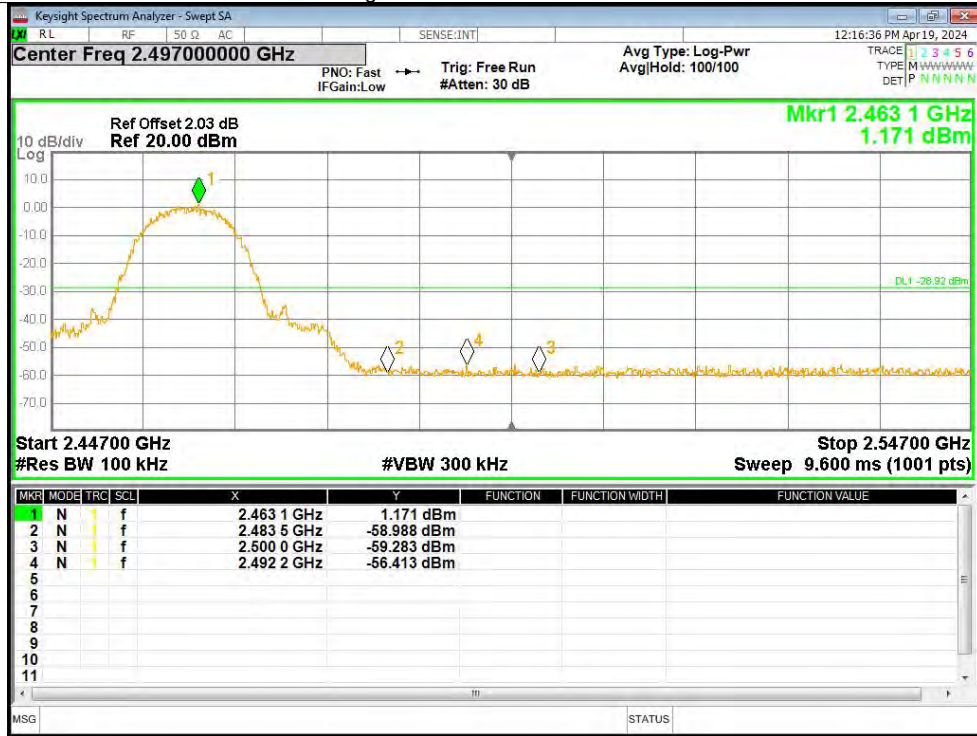



Band Edge NVNT g 2412MHz Ant1 Ref

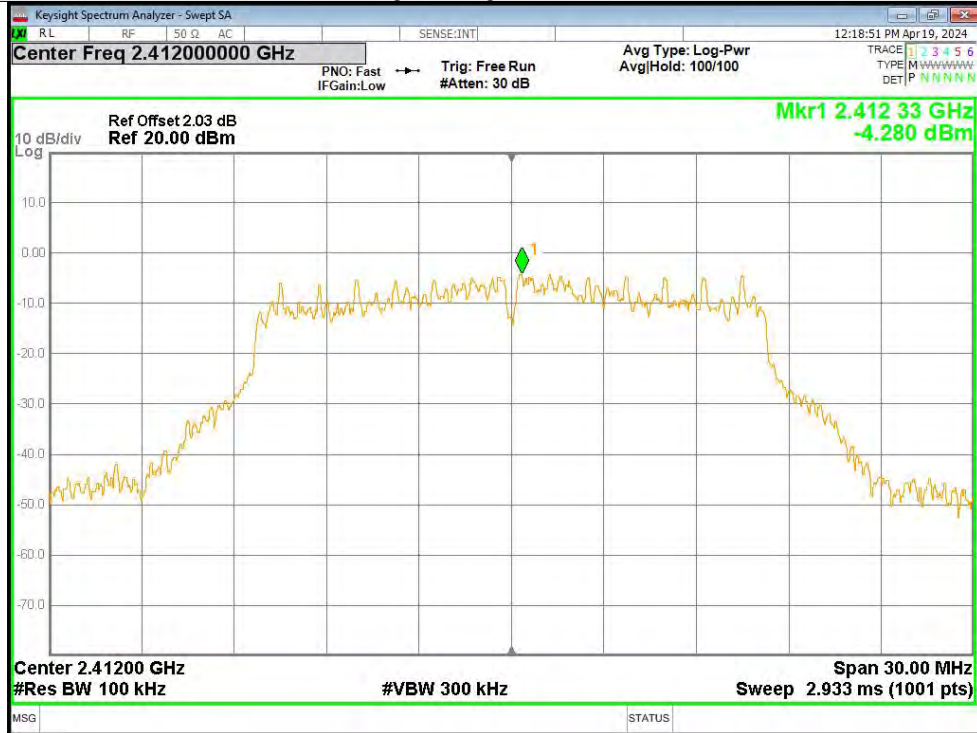

Band Edge NVNT g 2412MHz Ant1 Emission

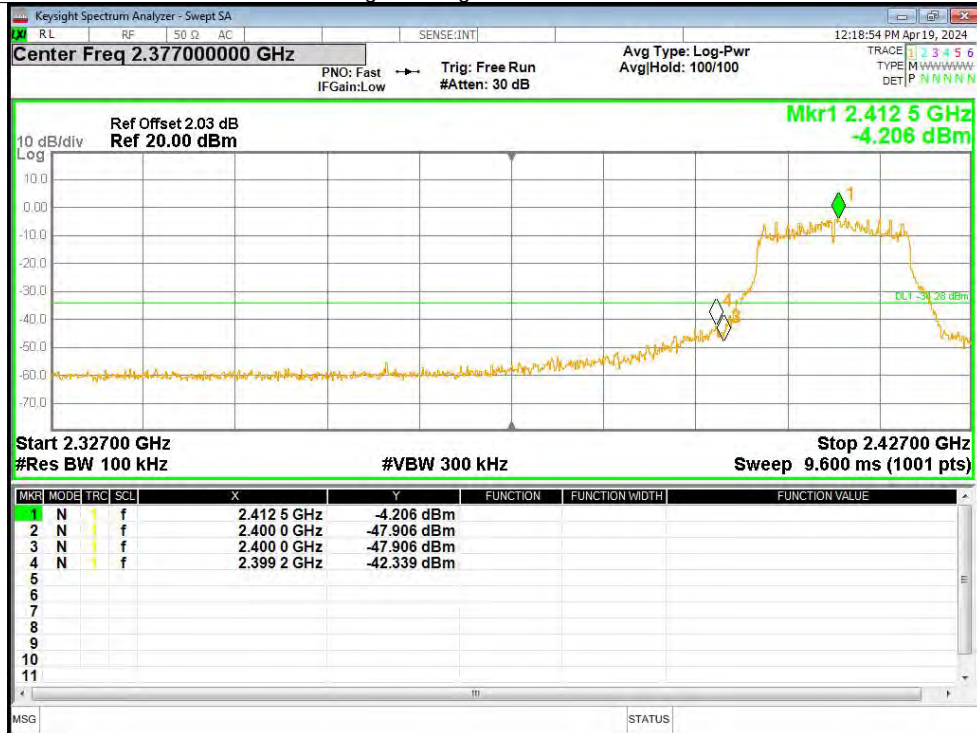



Band Edge NVNT g 2462MHz Ant1 Ref

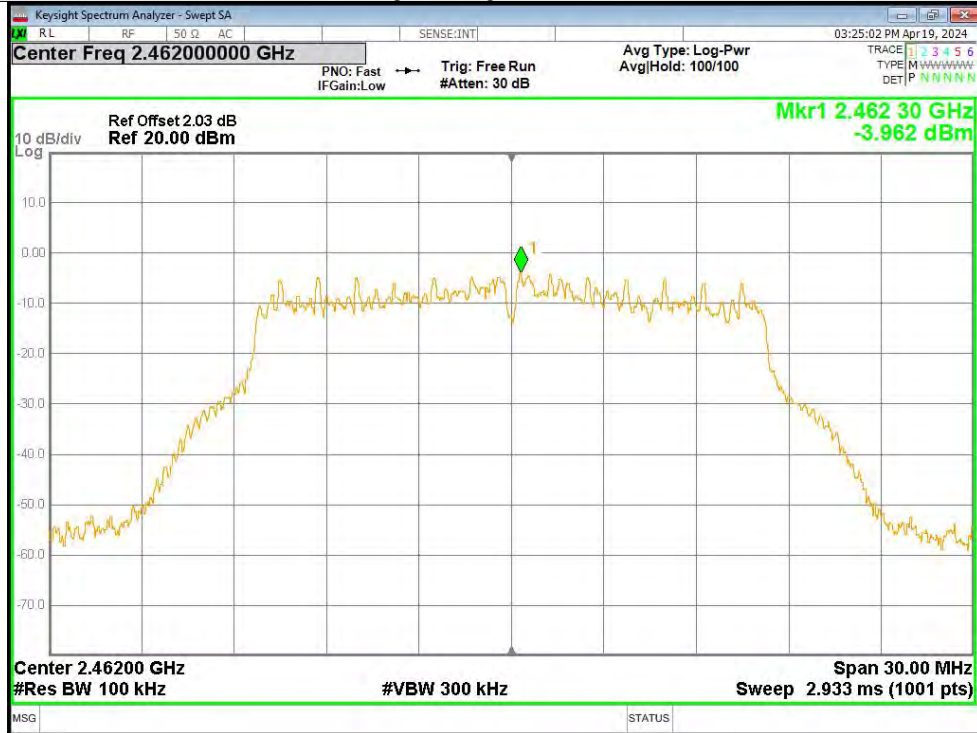

Band Edge NVNT g 2462MHz Ant1 Emission

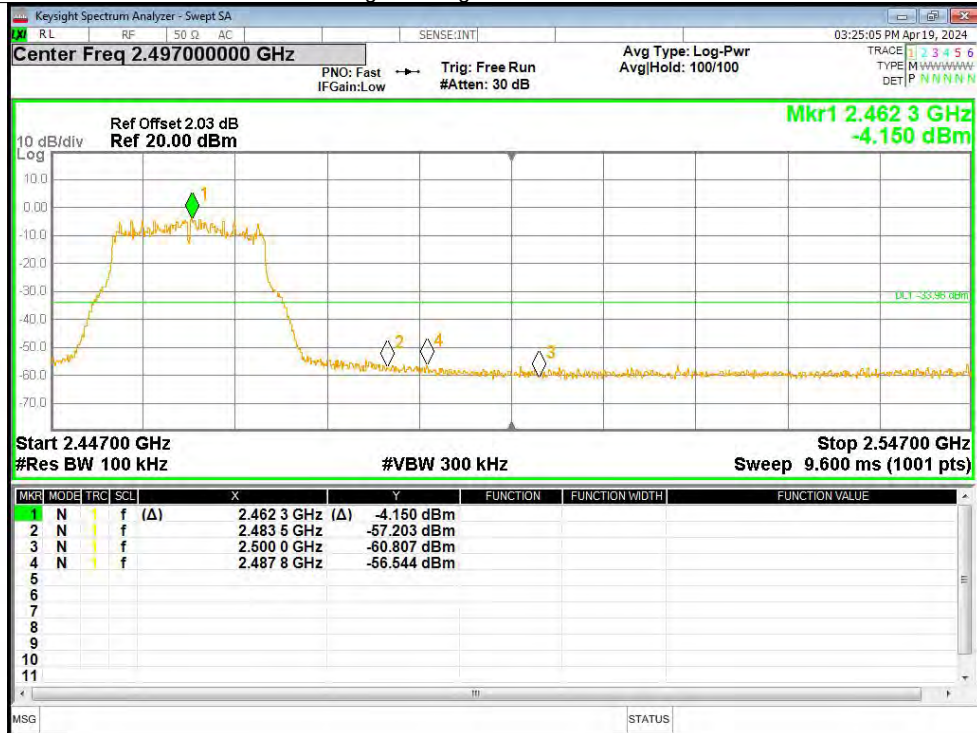

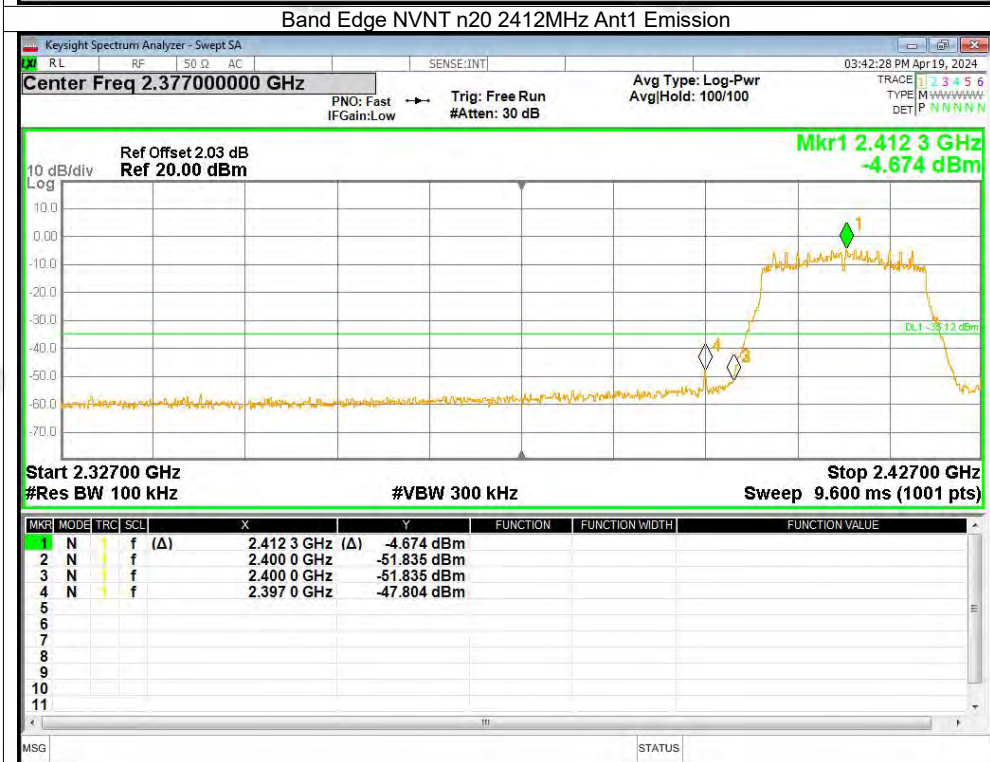
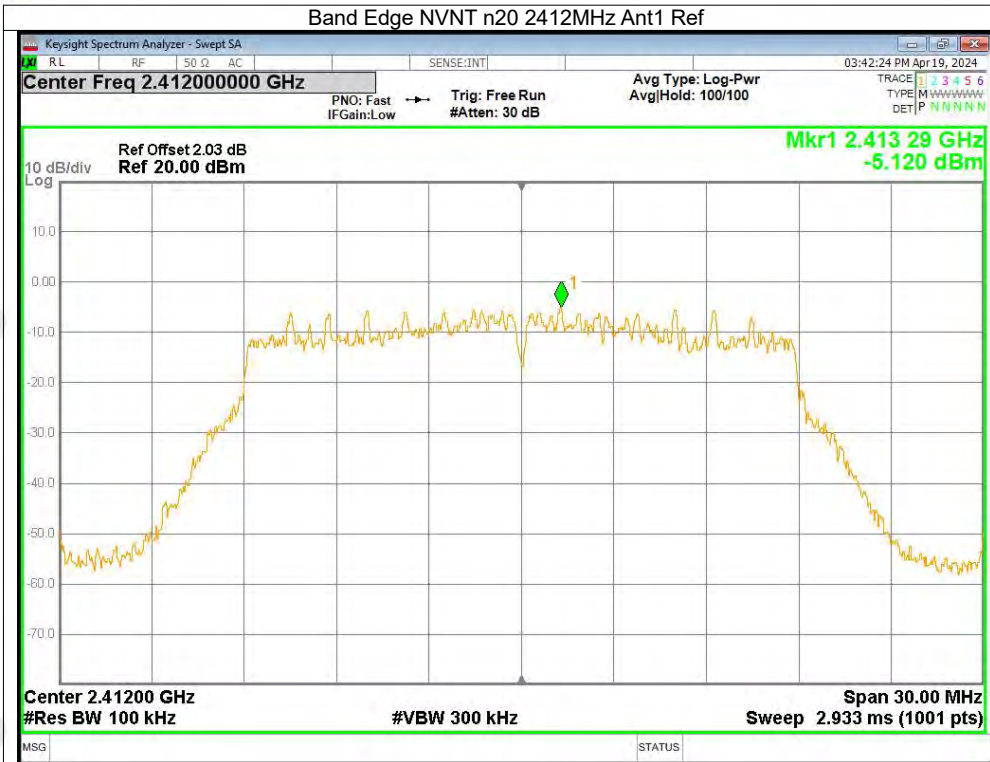



Band Edge NVNT n20 2462MHz Ant1 Ref

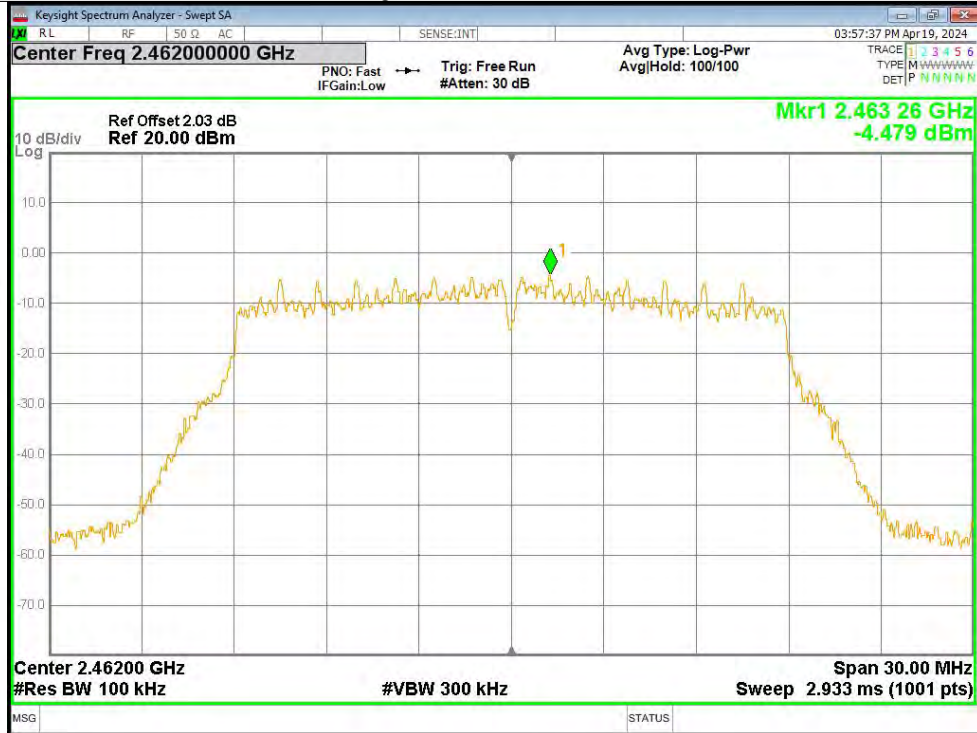

Band Edge NVNT n20 2462MHz Ant1 Emission

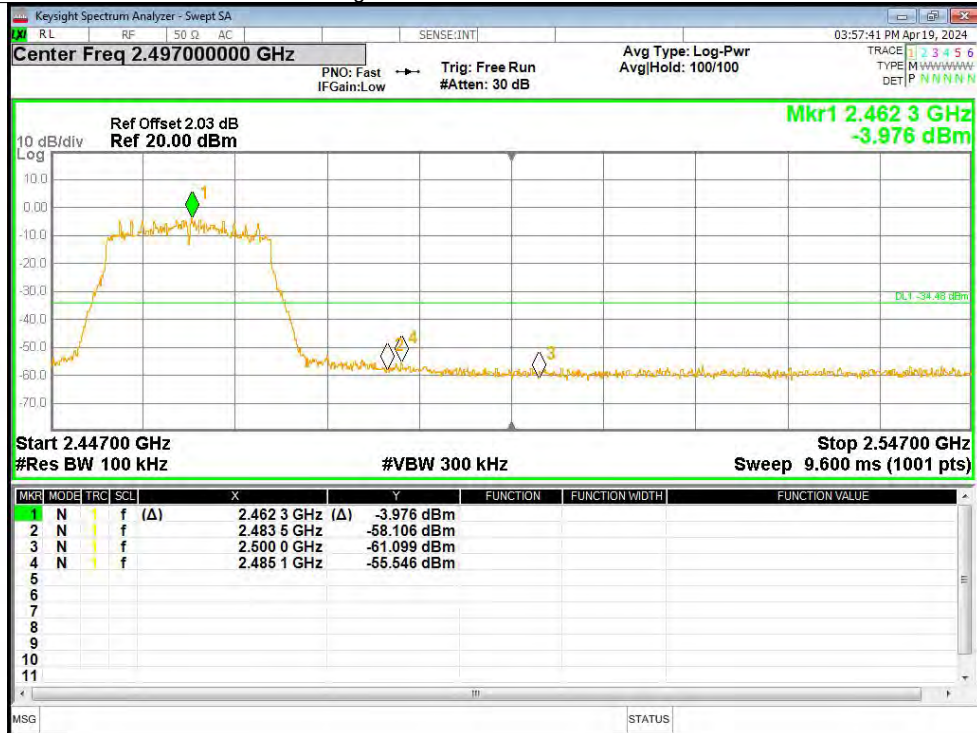



Conducted RF Spurious Emission

Condition	Mode	Frequency (MHz)	Antenna	Max Value (dBc)	Limit (dBc)	Verdict
NVNT	b	2412	Ant1	-40.48	-30	Pass
NVNT	b	2437	Ant1	-42.07	-30	Pass
NVNT	b	2462	Ant1	-43.73	-30	Pass
NVNT	g	2412	Ant1	-39.4	-30	Pass
NVNT	g	2437	Ant1	-42.54	-30	Pass
NVNT	g	2462	Ant1	-42.52	-30	Pass
NVNT	n20	2412	Ant1	-40.89	-30	Pass
NVNT	n20	2437	Ant1	-41.37	-30	Pass
NVNT	n20	2462	Ant1	-41.28	-30	Pass



Test Graphs

Tx. Spurious NVNT b 2412MHz Ant1 Ref

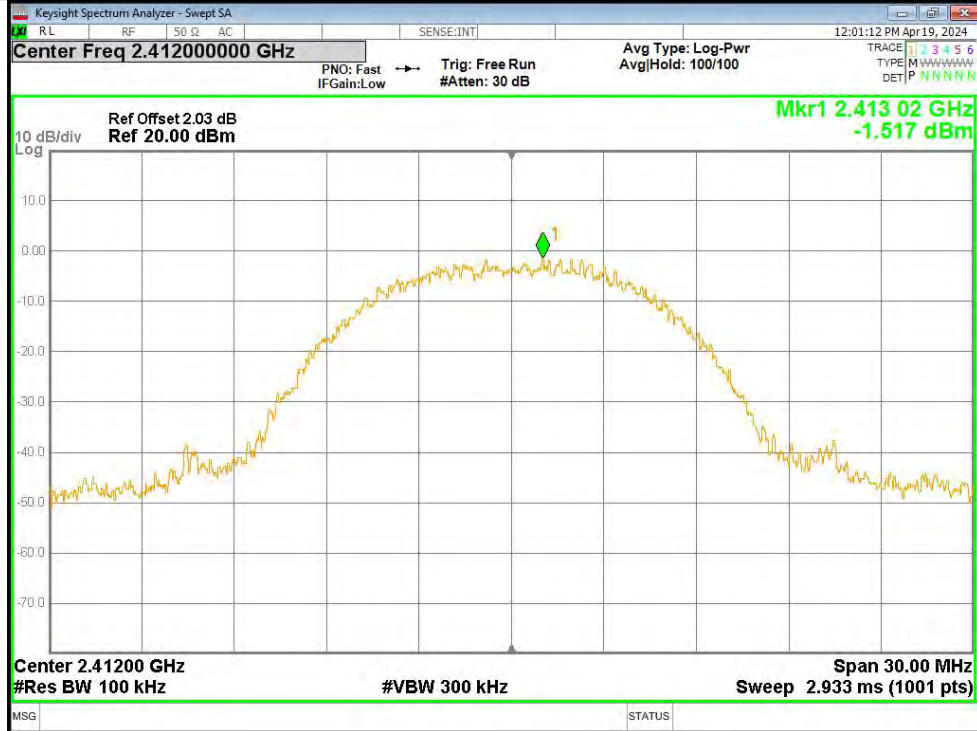

Tx. Spurious NVNT b 2412MHz Ant1 Emission

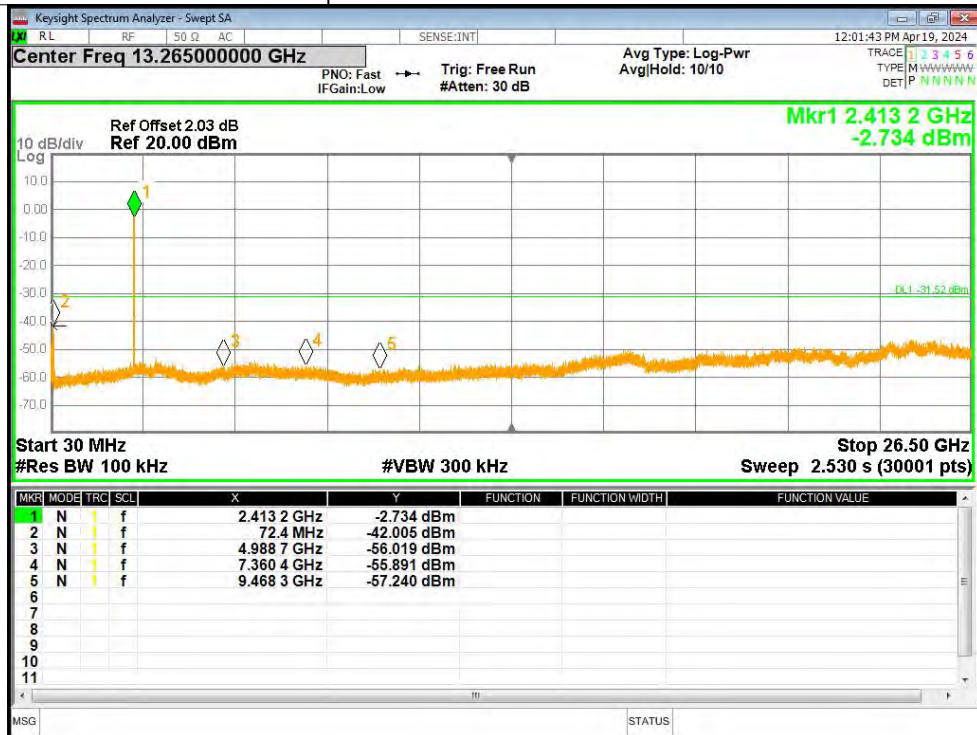



Tx. Spurious NVNT b 2437MHz Ant1 Ref

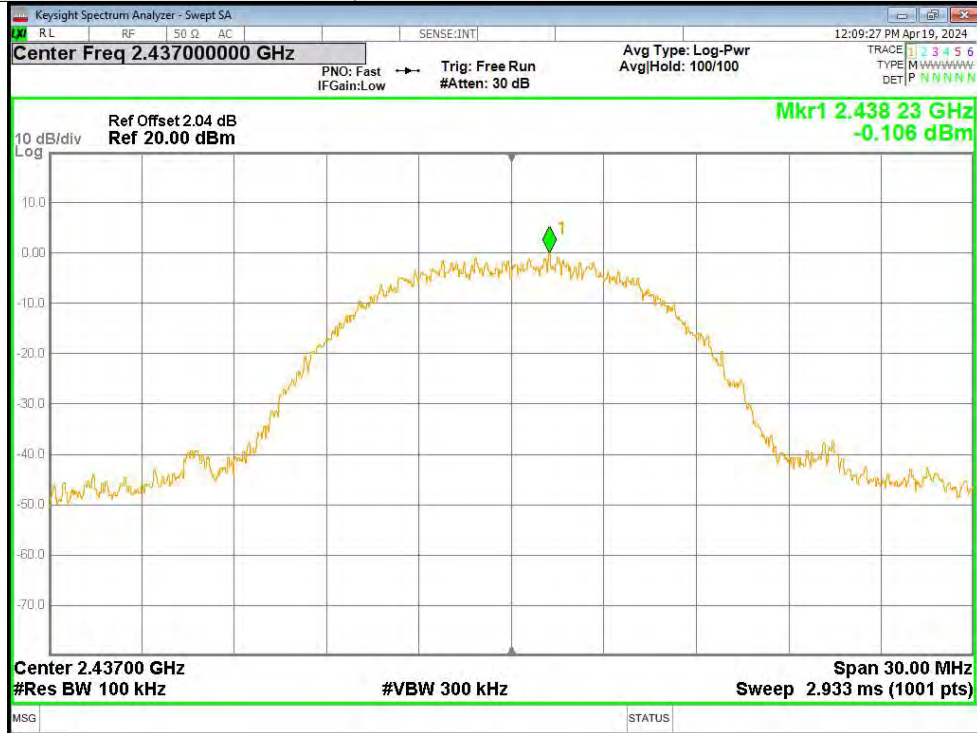

Tx. Spurious NVNT b 2437MHz Ant1 Emission

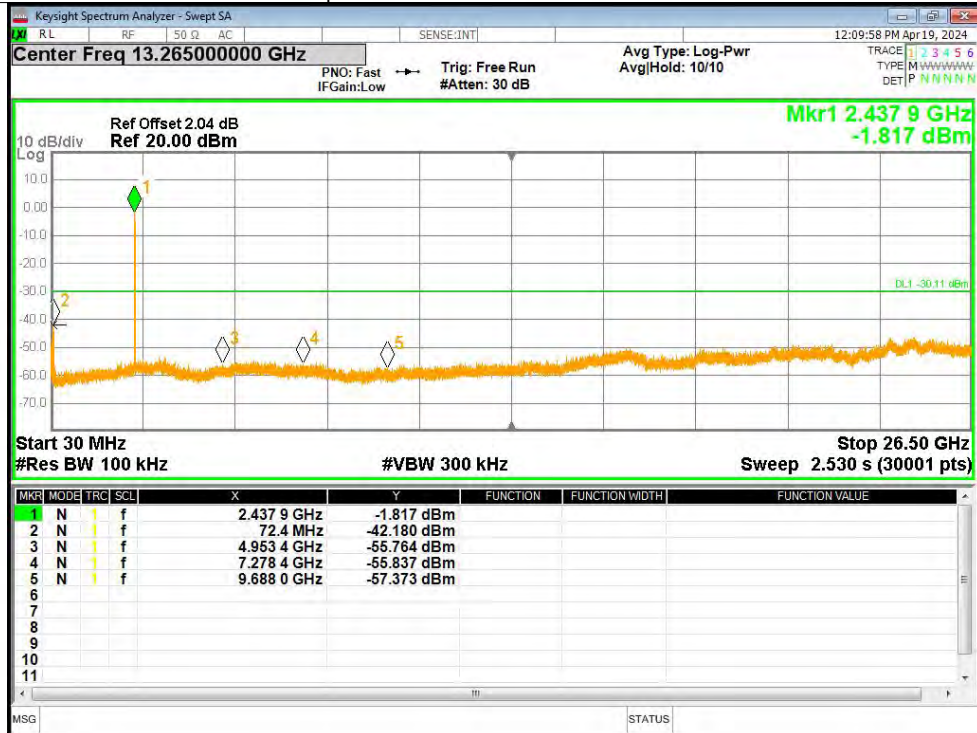



Tx. Spurious NVNT b 2462MHz Ant1 Ref

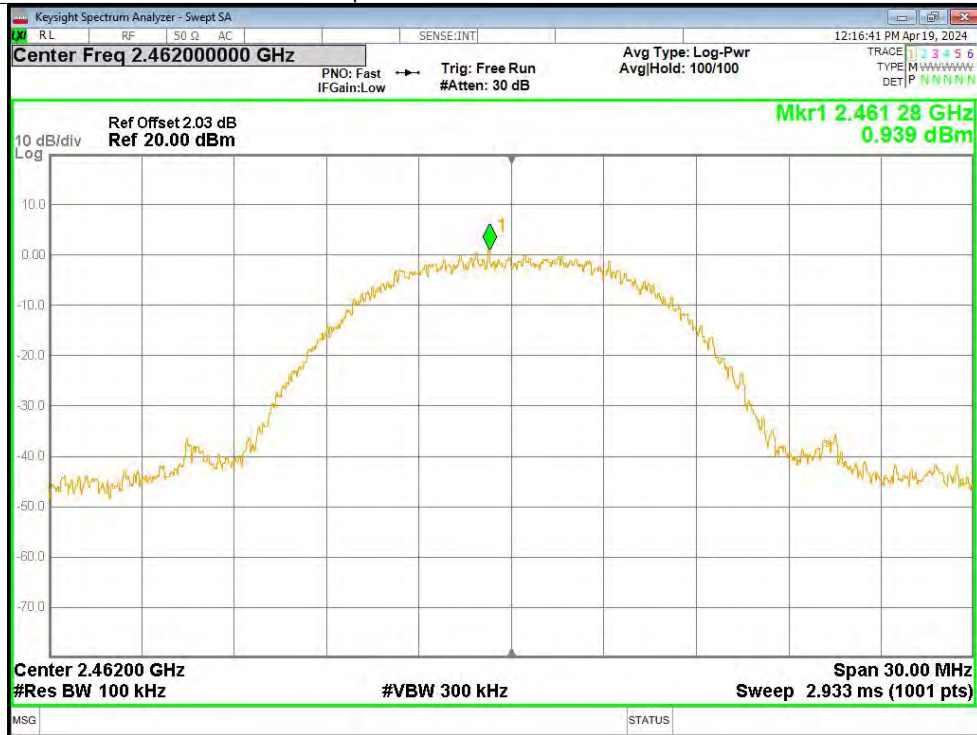

Tx. Spurious NVNT b 2462MHz Ant1 Emission

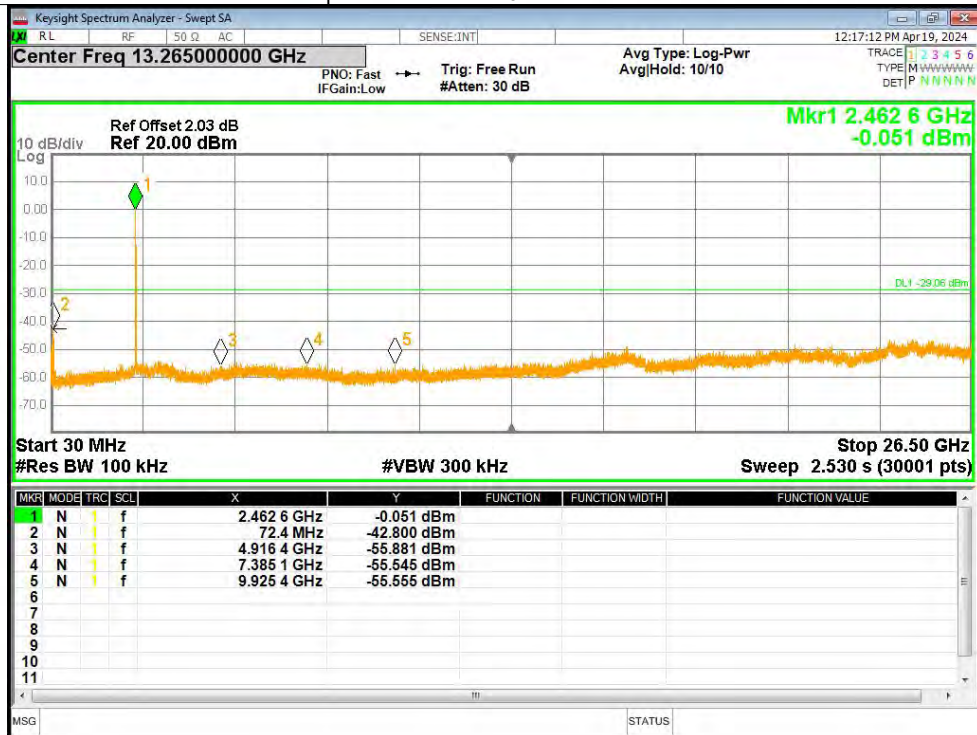



Tx. Spurious NVNT g 2412MHz Ant1 Ref

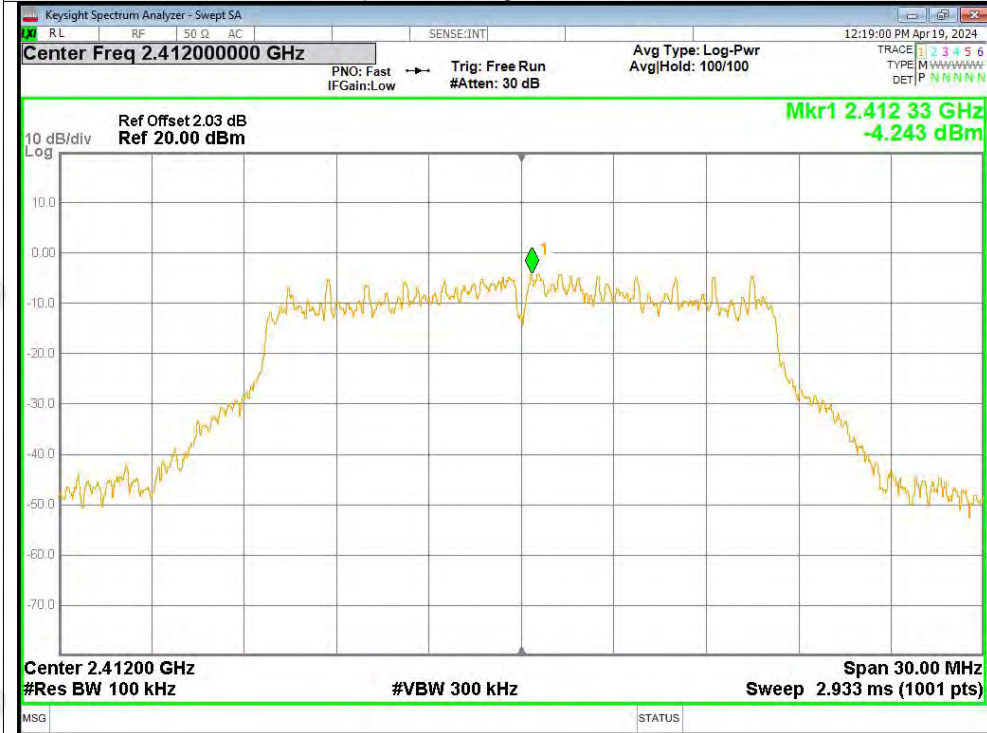

Tx. Spurious NVNT g 2412MHz Ant1 Emission

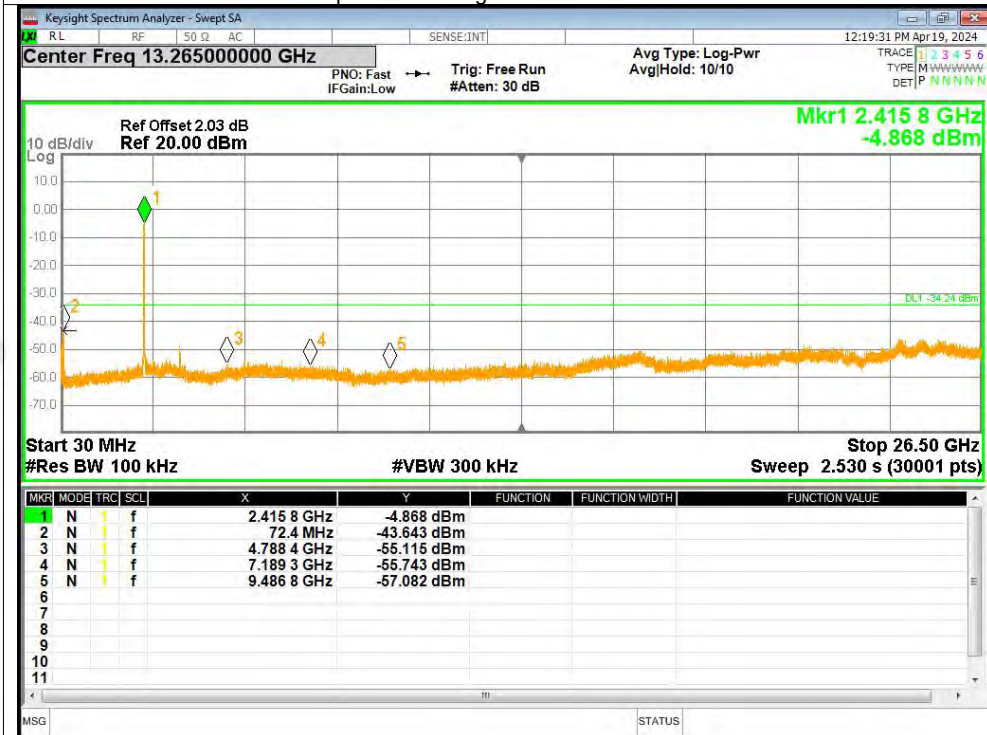



Tx. Spurious NVNT g 2437MHz Ant1 Ref

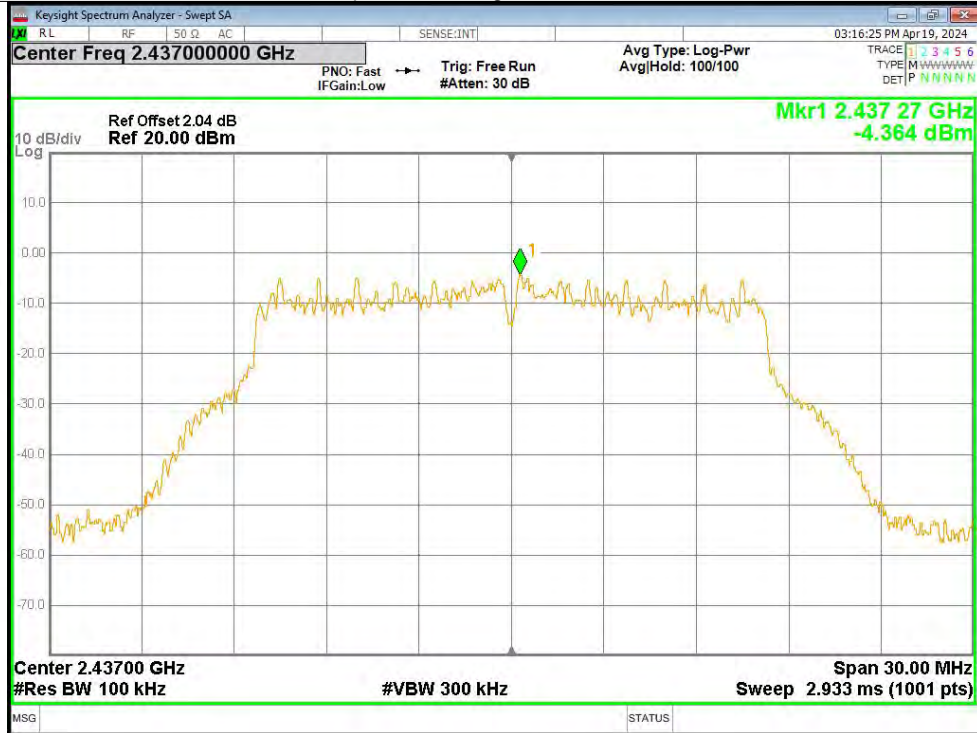

Tx. Spurious NVNT g 2437MHz Ant1 Emission

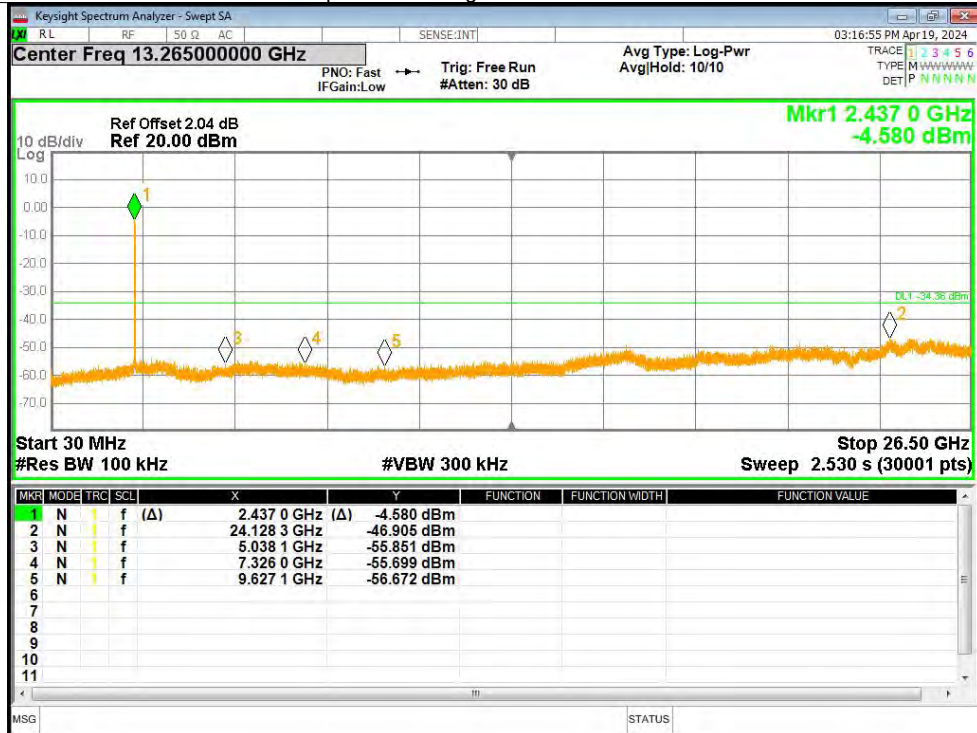



Tx. Spurious NVNT g 2462MHz Ant1 Ref

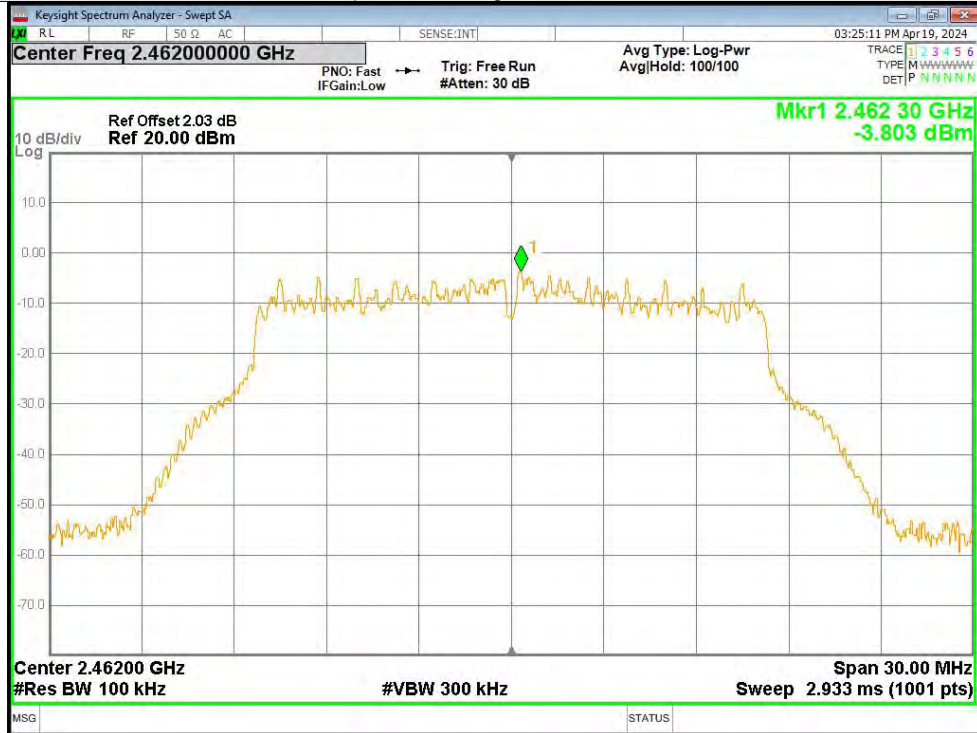

Tx. Spurious NVNT g 2462MHz Ant1 Emission

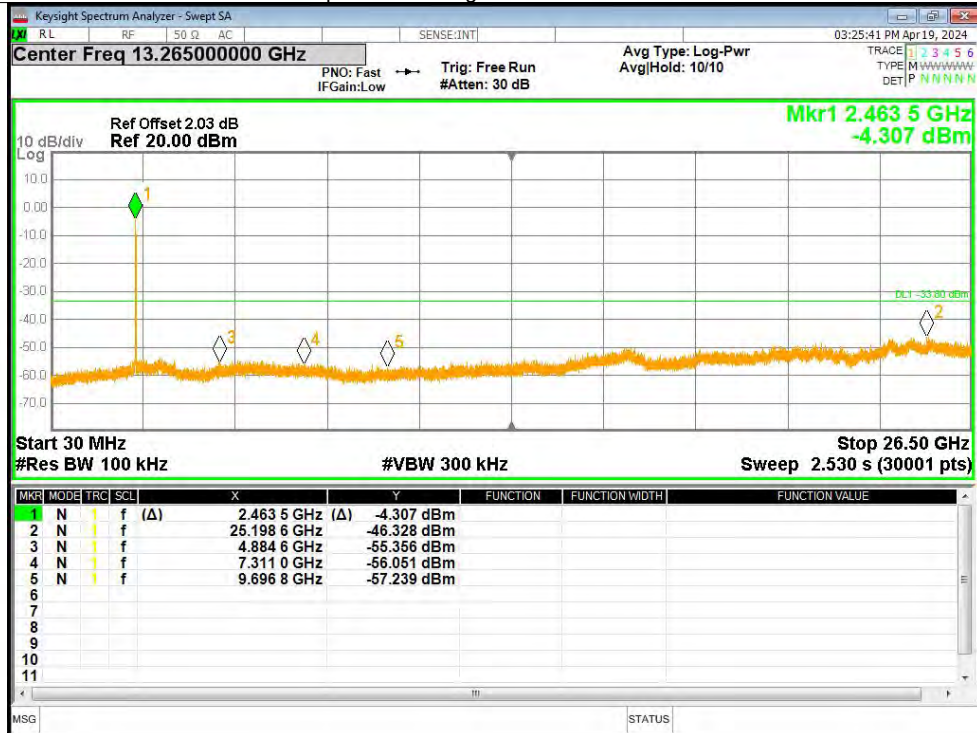



Tx. Spurious NVNT n20 2412MHz Ant1 Ref

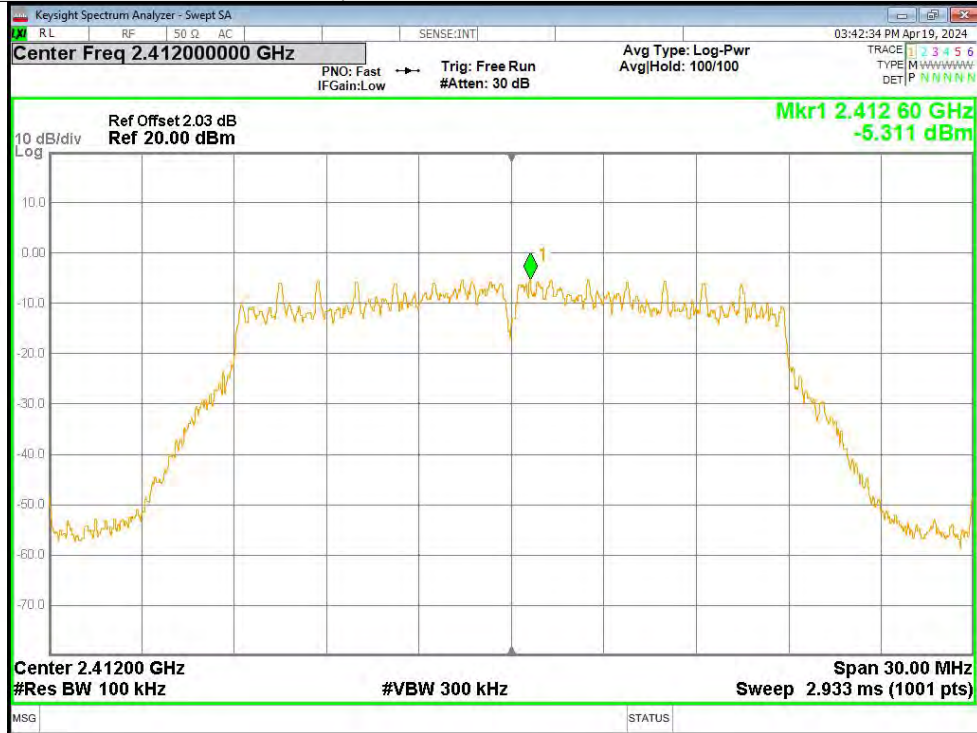

Tx. Spurious NVNT n20 2412MHz Ant1 Emission

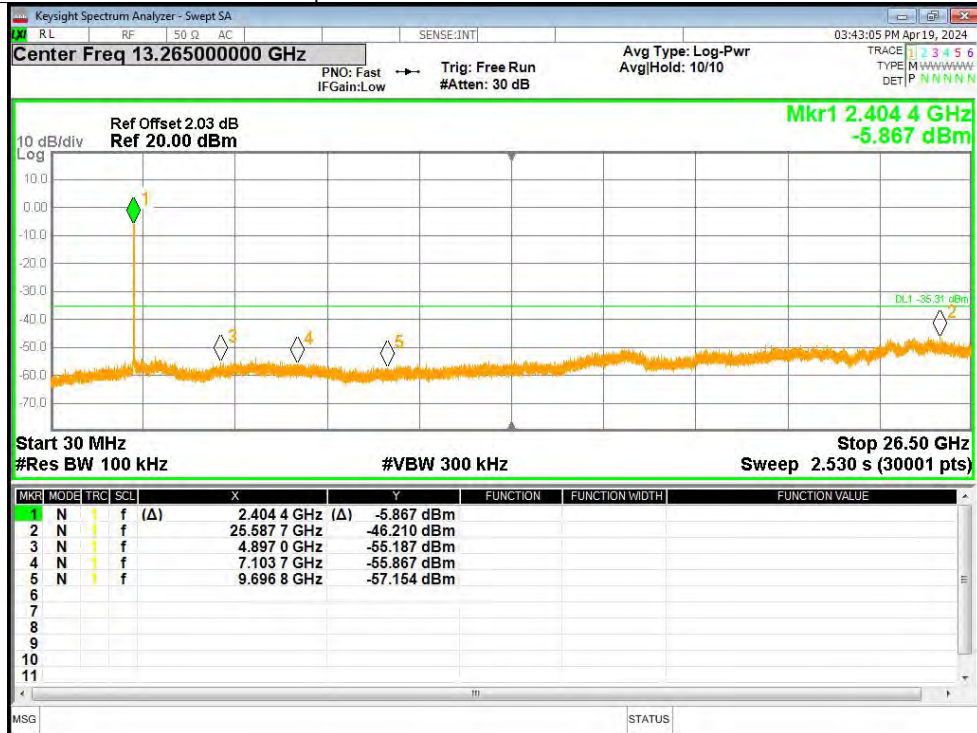



Tx. Spurious NVNT n20 2437MHz Ant1 Ref

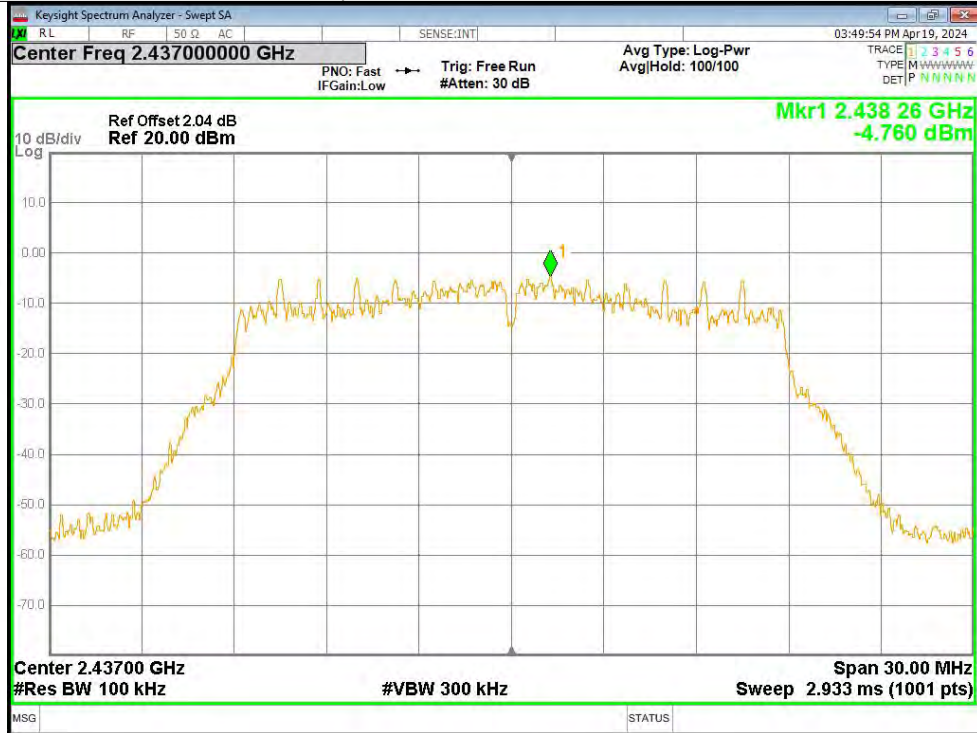

Tx. Spurious NVNT n20 2437MHz Ant1 Emission

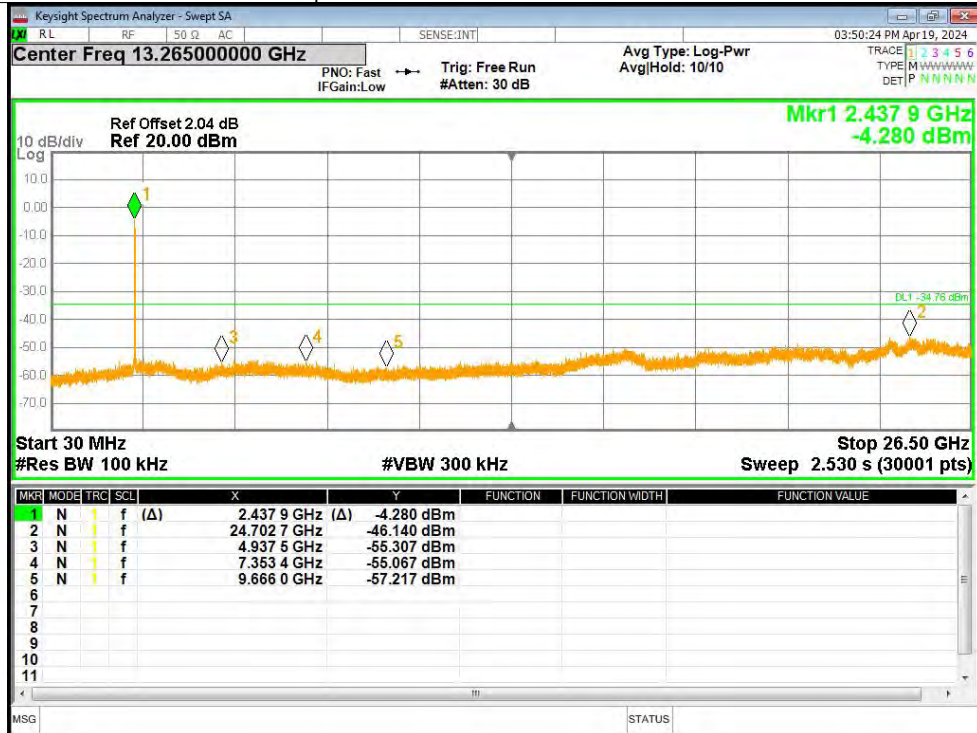



Tx. Spurious NVNT n20 2462MHz Ant1 Ref

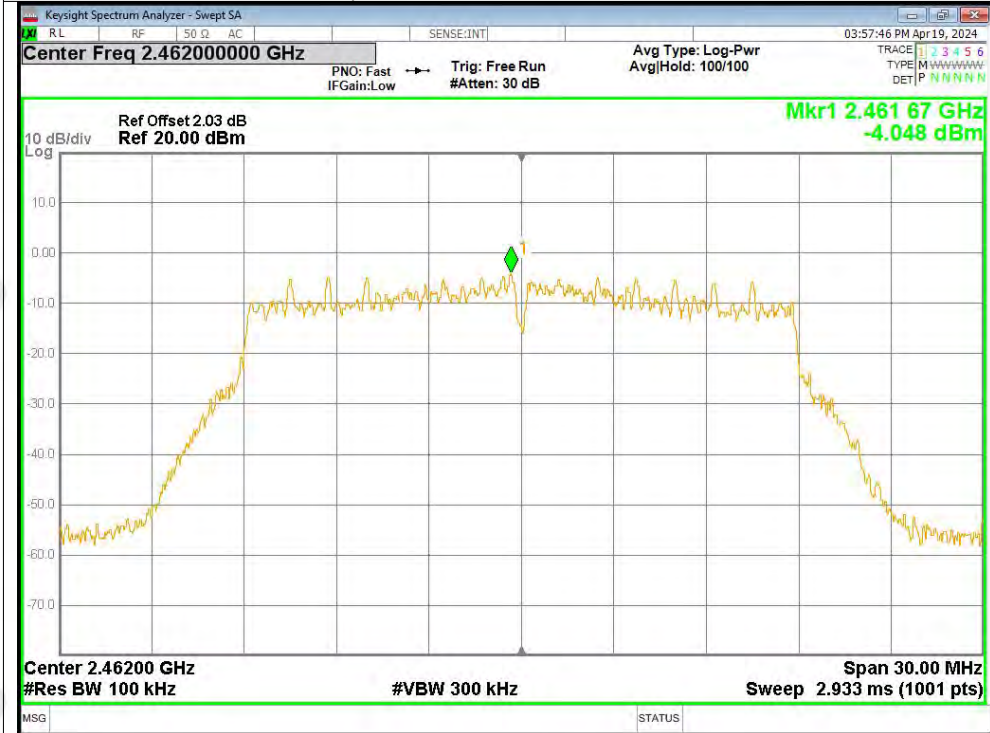

Tx. Spurious NVNT n20 2462MHz Ant1 Emission

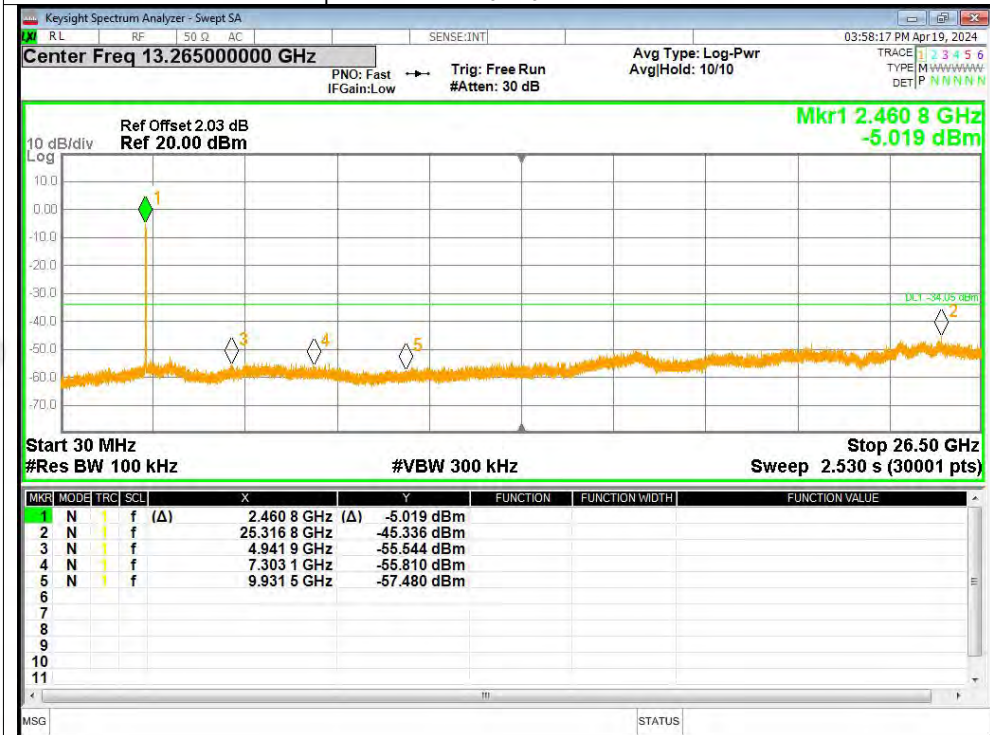



12. TEST SETUP PHOTO

Reference to the appendix I for details.

13. EUT CONSTRUCTIONAL DETAILS

Reference to the appendix II for details.

***** END OF REPORT *****