

APPLICATION CERTIFICATION FCC Part 15C
On Behalf of
SES-imagotag Deutschland GmbH

ESL accesspoint
Model No.: SMARTAP 320

FCC ID: 2APO5-SMARTAP320

Prepared for : SES-imagotag Deutschland GmbH
Address : Bundesstrasse 16, D-77955 Ettenheim Germany

Prepared by : Shenzhen Accurate Technology Co., Ltd.
Address : 1/F., Building A, Changyuan New Material Port, Science
& Industry Park, Nanshan District, Shenzhen, Guangdong,
P.R. China

Tel: (0755) 26503290
Fax: (0755) 26503396

Report No. : ATE20181306
Date of Test : July 20-August 13, 2018
Date of Report : August 16, 2018

TABLE OF CONTENTS

Description	Page
Test Report Certification	
1. GENERAL INFORMATION	5
1.1. Description of Device (EUT).....	5
1.2. Carrier Frequency of Channels.....	6
1.3. Accessory and Auxiliary Equipment	6
1.4. Description of Test Facility	7
1.5. Measurement Uncertainty.....	7
2. MEASURING DEVICE AND TEST EQUIPMENT	8
3. OPERATION OF EUT DURING TESTING	9
3.1. Operating Mode.....	9
3.2. Configuration and peripherals	9
4. TEST PROCEDURES AND RESULTS	10
5. POWER LINE CONDUCTED MEASUREMENT	11
5.1. Block Diagram of Test Setup.....	11
5.2. Power Line Conducted Emission Measurement Limits.....	12
5.3. Configuration of EUT on Measurement	12
5.4. Operating Condition of EUT	12
5.5. Test Procedure	12
5.6. Data Sample.....	13
5.7. Power Line Conducted Emission Measurement Results	13
6. 6DB BANDWIDTH MEASUREMENT.....	18
6.1. Block Diagram of Test Setup.....	18
6.2. The Requirement For Section 15.247(a)(2).....	18
6.3. EUT Configuration on Measurement	18
6.4. Operating Condition of EUT	18
6.5. Test Procedure	18
6.6. Test Result	19
7. MAXIMUM PEAK OUTPUT POWER	22
7.1. Block Diagram of Test Setup.....	22
7.2. The Requirement For Section 15.247(b)(3).....	22
7.3. EUT Configuration on Measurement	22
7.4. Operating Condition of EUT	22
7.5. Test Procedure	22
7.6. Test Result	23
8. POWER SPECTRAL DENSITY MEASUREMENT.....	26
8.1. Block Diagram of Test Setup.....	26
8.2. The Requirement For Section 15.247(e).....	26
8.3. EUT Configuration on Measurement	26
8.4. Operating Condition of EUT	26
8.5. Test Procedure	27
8.6. Test Result	27
9. BAND EDGE COMPLIANCE TEST	30
9.1. Block Diagram of Test Setup.....	30
9.2. The Requirement For Section 15.247(d)	30

- 9.3. EUT Configuration on Measurement30
- 9.4. Operating Condition of EUT30
- 9.5. Test Procedure31
- 9.6. Test Result31
- 10. RADIATED SPURIOUS EMISSION TEST38**
 - 10.1. Block Diagram of Test Setup.....38
 - 10.2. The Limit For Section 15.247(d)39
 - 10.3. Restricted bands of operation40
 - 10.4. Configuration of EUT on Measurement40
 - 10.5. Operating Condition of EUT41
 - 10.6. Test Procedure41
 - 10.7. Data Sample.....42
 - 10.8. The Field Strength of Radiation Emission Measurement Results42
- 11. ANTENNA REQUIREMENT.....55**
 - 11.1. The Requirement55
 - 11.2. Antenna Construction55

Test Report Certification

Applicant : SES-imagotag Deutschland GmbH
Manufacturer : SES-imagotag Deutschland GmbH
Product : ESL accesspoint
Model No. : SMARTAP 320

Measurement Procedure Used:

**FCC Rules and Regulations Part 15 Subpart C Section 15.247
ANSI C63.10: 2013**

The EUT was tested according to DTS test procedure of Apr 05, 2017 KDB558074 D01 DTS Meas Guidance v04 for compliance to FCC 47CFR 15.247 requirements

The device described above is tested by Shenzhen Accurate Technology Co., Ltd. to determine the maximum emission levels emanating from the device. The maximum emission levels are compared to the FCC Part 15 Subpart C Section 15.247 limits. The measurement results are contained in this test report and Shenzhen Accurate Technology Co., Ltd. is assumed full responsibility for the accuracy and completeness of these measurements. Also, this report shows that the Equipment Under Test (EUT) is to be technically compliant with the FCC requirements.

This report applies to above tested sample only. This report shall not be reproduced in part without written approval of Shenzhen Accurate Technology Co., Ltd.

Date of Test : July 20-August 13, 2018
Date of Report : August 16, 2018

Prepared by : _____
(Sean Yang, Engineer)

Approved & Authorized Signer : _____
(Sean Liu, Manager)



1. GENERAL INFORMATION

1.1. Description of Device (EUT)

EUT	:	ESL accesspoint
Model Number	:	SMARTAP 320
Frequency Range	:	903.375-926.475MHz
Number of Channels	:	43
Modulation Type	:	DSSS
Antenna Gain	:	-2.3 dBi
Type of Antenna	:	External Antenna
Power Supply	:	DC 5V (Powered by adapter)
Adapter Information	:	Model: PSC15R-050 Input: AC 100-240V ~ 50-60Hz 0.5A Output: 5.0V == 3.0A
Applicant	:	SES-imagotag Deutschland GmbH
Address	:	Bundesstrasse 16, D-77955 Ettenheim Germany
Manufacturer	:	SES-imagotag Deutschland GmbH
Address	:	Bundesstrasse 16, D-77955 Ettenheim Germany

1.2. Carrier Frequency of Channels

Chan-Index	Center-Freq	Chan-Index	Center-Freq
-33	903,3750	-11	915,4750
-32	903,9250	-10	916,0250
-31	904,4750	-9	916,5750
-30	905,0250	-8	917,1250
-29	905,5750	-7	917,6750
-28	906,1250	-6	918,2250
-27	906,6750	-5	918,7750
-26	907,2250	-4	919,3250
-25	907,7750	-3	919,8750
-24	908,3250	-2	920,4250
-23	908,8750	-1	920,9750
-22	909,4250	0	921,5250
-21	909,9750	1	922,0750
-20	910,5250	2	922,6250
-19	911,0750	3	923,1750
-18	911,6250	4	923,7250
-17	912,1750	5	924,2750
-16	912,7250	6	924,8250
-15	913,2750	7	925,3750
-14	913,8250	8	925,9250
-13	914,3750	9	926,4750
-12	914,9250		

1.3. Accessory and Auxiliary Equipment

N/A

1.4. Description of Test Facility

- EMC Lab : Recognition of accreditation by Federal Communications Commission (FCC)
The Designation Number is CN1189
The Registration Number is 708358
- Listed by Innovation, Science and Economic Development Canada (ISED)
The Registration Number is 5077A-2
- Accredited by China National Accreditation Service for Conformity Assessment (CNAS)
The Registration Number is CNAS L3193
- Accredited by American Association for Laboratory Accreditation (A2LA)
The Certificate Number is 4297.01
- Name of Firm : Shenzhen Accurate Technology Co., Ltd.
Site Location : 1/F., Building A, Changyuan New Material Port, Science & Industry Park, Nanshan District, Shenzhen, Guangdong, P.R. China

1.5. Measurement Uncertainty

- Conducted Emission Expanded Uncertainty = 2.23dB, k=2
- Radiated emission expanded uncertainty (9kHz-30MHz) = 3.08dB, k=2
- Radiated emission expanded uncertainty (30MHz-1000MHz) = 4.42dB, k=2
- Radiated emission expanded uncertainty (Above 1GHz) = 4.06dB, k=2

2. MEASURING DEVICE AND TEST EQUIPMENT

Table 1: List of Test and Measurement Equipment

Kind of equipment	Manufacturer	Type	S/N	Calibrated dates	Calibrated until
EMI Test Receiver	Rohde&Schwarz	ESCS30	100307	Jan. 06, 2018	1 Year
EMI Test Receiver	Rohde&Schwarz	ESR	101817	Jan. 06, 2018	1 Year
Spectrum Analyzer	Rohde&Schwarz	FSV-40	101495	Jan. 06, 2018	1 Year
Pre-Amplifier	Rohde&Schwarz	CBLU1183540-01	3791	Jan. 06, 2018	1 Year
Loop Antenna	Schwarzbeck	FMZB1516	1516131	Jan. 06, 2018	1 Year
Bilog Antenna	Schwarzbeck	VULB9163	9163-323	Jan. 06, 2018	1 Year
Horn Antenna	Schwarzbeck	BBHA9120D	9120D-655	Jan. 06, 2018	1 Year
Horn Antenna	Schwarzbeck	BBHA9170	9170-359	Jan. 06, 2018	1 Year
LISN	Schwarzbeck	NSLK8126	8126431	Jan. 06, 2018	1 Year
Highpass Filter	Wainwright Instruments	WHKX3.6/18G-10SS	N/A	Jan. 06, 2018	1 Year
Band Reject Filter	Wainwright Instruments	WRCG2400/2485-2375 /2510-60/11SS	N/A	Jan. 06, 2018	1 Year

3. OPERATION OF EUT DURING TESTING

3.1. Operating Mode

The mode is used: **Transmitting mode**

Low Channel: 903.375MHz

Middle Channel: 914.375MHz

High Channel: 926.475MHz

3.2. Configuration and peripherals

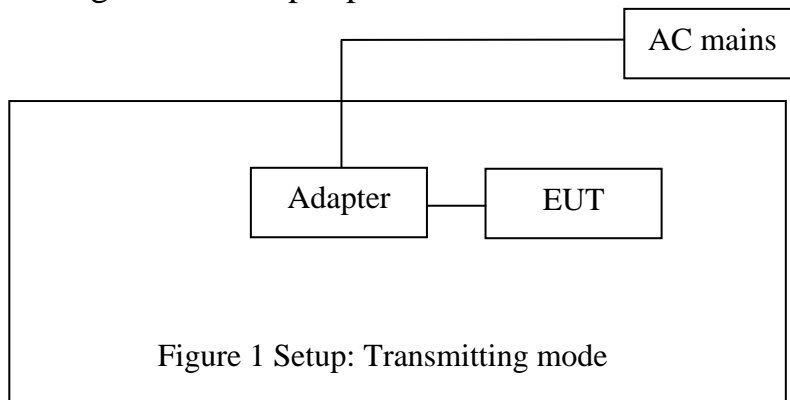

RX Antenna

TX Antenna

Note: The product has two antennas, The left side is only used as RX Antenna, and the right side is only used as TX Antenna.

4. TEST PROCEDURES AND RESULTS

FCC Rules	Description of Test	Result
Section 15.207	AC Power Line Conducted Emission Test	Compliant
Section 15.247(a)(2)	6dB Bandwidth Test	Compliant
Section 15.247(b)(3)	Maximum Peak Output Power Test	Compliant
Section 15.247(e)	Power Spectral Density Test	Compliant
Section 15.247(d)	Band Edge Compliance Test	Compliant
Section 15.247(d) Section 15.209	Radiated Spurious Emission Test	Compliant
Section 15.203	Antenna Requirement	Compliant

5. POWER LINE CONDUCTED MEASUREMENT

5.1. Block Diagram of Test Setup

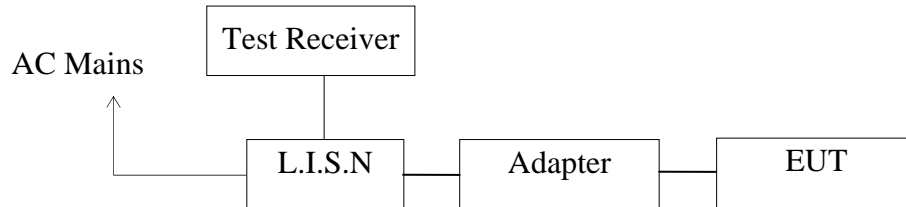

5.1.1. Test System Setup

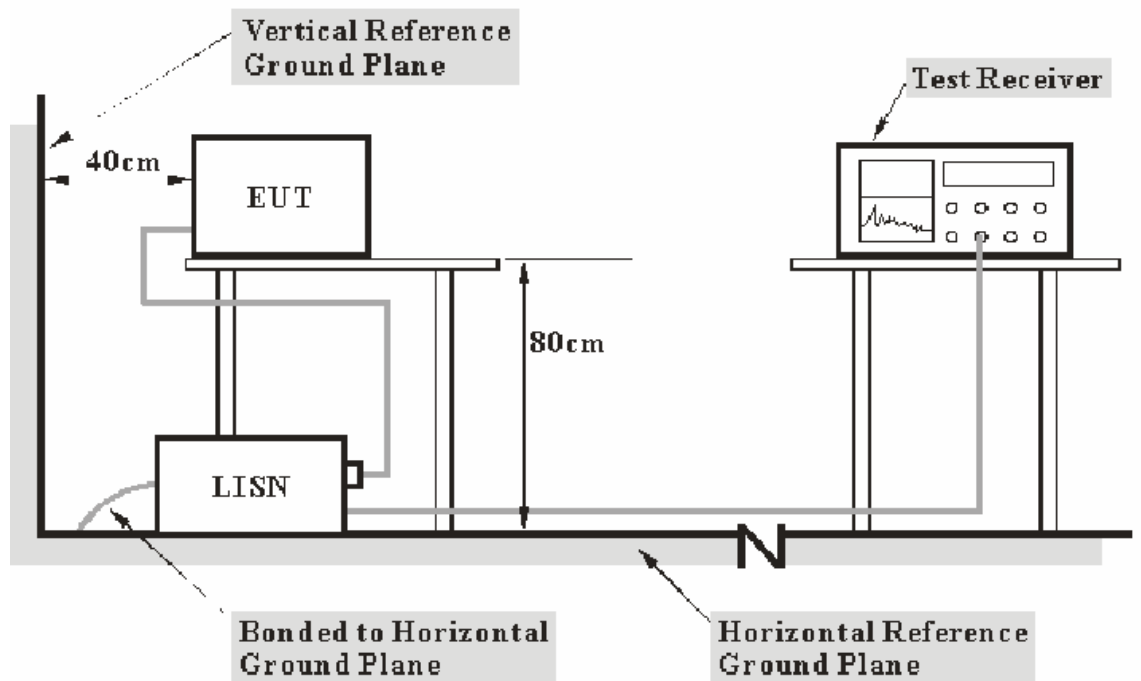

- Note:**
1. Support units were connected to second LISN.
 2. Both of LISNs (AMN) 80 cm from EUT and at the least 80 cm from other units and other metal planes support units.

5.2. Power Line Conducted Emission Measurement Limits

Frequency (MHz)	Limit dB(μV)	
	Quasi-peak Level	Average Level
0.15 - 0.50	66.0 – 56.0 *	56.0 – 46.0 *
0.50 - 5.00	56.0	46.0
5.00 - 30.00	60.0	50.0

NOTE1: The lower limit shall apply at the transition frequencies.
NOTE2: The limit decreases linearly with the logarithm of the frequency in the range 0.15MHz to 0.50MHz.

5.3. Configuration of EUT on Measurement

The equipments are installed on Power Line Conducted Emission Measurement to meet the commission requirement and operating regulations in a manner, which tends to maximize its emission characteristics in a normal application.

5.4. Operating Condition of EUT

- 5.4.1. Setup the EUT and simulator as shown as Section 5.1.
- 5.4.2. Turn on the power of all equipment.
- 5.4.3. Let the EUT work in test mode and measure it.

5.5. Test Procedure

The EUT is put on the plane 0.8 m high above the ground by insulating support and is connected to the power mains through a line impedance stabilization network (L.I.S.N.). This provides a 50ohm coupling impedance for the EUT system. Please refer the block diagram of the test setup and photographs. Both sides of AC lines are checked to find out the maximum conducted emission. In order to find the maximum emission levels, the relative positions of equipment and all of the interface cables shall be changed according to ANSI C63.10: 2013 on Conducted Emission Measurement.

The bandwidth of test receiver (R & S ESCS30) is set at 9kHz.

The frequency range from 150kHz to 30MHz is checked.

5.6.Data Sample

Frequency (MHz)	Transducer value (dB)	QuasiPeak Level (dB μ V)	Average Level (dB μ V)	QuasiPeak Limit (dB μ V)	Average Limit (dB μ V)	QuasiPeak Margin (dB)	Average Margin (dB)	Remark (Pass/Fail)
X.XX	10.5	51.1	34.2	56.0	46.0	4.9	11.8	Pass

Frequency(MHz) = Emission frequency in MHz

Transducer value(dB) = Insertion loss of LISN + Cable Loss

Level(dB μ V) = Quasi-peak Reading/Average Reading + Transducer value

Limit (dB μ V) = Limit stated in standard

Margin = Limit (dB μ V) - Level (dB μ V)

Calculation Formula:

Margin = Limit (dB μ V) - Level (dB μ V)

5.7.Power Line Conducted Emission Measurement Results

PASS.

Test Lab: Shielding room

Test Engineer: Star

The frequency range from 150kHz to 30MHz is checked.

Maximizing procedure was performed on the six (6) highest emissions of the EUT. Emissions attenuated more than 20 dB below the permissible value are not reported.

All data was recorded in the Quasi-peak and average detection mode.

The spectral diagrams are attached as below.

ACCURATE TECHNOLOGY CO., LTD

CONDUCTED EMISSION STANDARD FCC PART 15 C

EUT: ESL accesspoint M/N:SMARTAP 320
 Manufacturer: SES-inagotag Deutschland GmbH
 Operating Condition: Wireless communication
 Test Site: 1#Shielding Room
 Operator: star
 Test Specification: L 120V/60Hz
 Comment: Report No.: ATE20181306
 Start of Test: 8/15/2018 / 9:52:24AM

SCAN TABLE: "V 9K-30MHz fin"

Start Frequency	Stop Frequency	Step Width	Detector	Meas. Time	IF Bandw.	Transducer
9.0 kHz	150.0 kHz	100.0 Hz	QuasiPeak	1.0 s	200 Hz	NSLK8126 2008
150.0 kHz	30.0 MHz	5.0 kHz	QuasiPeak	1.0 s	9 kHz	NSLK8126 2008

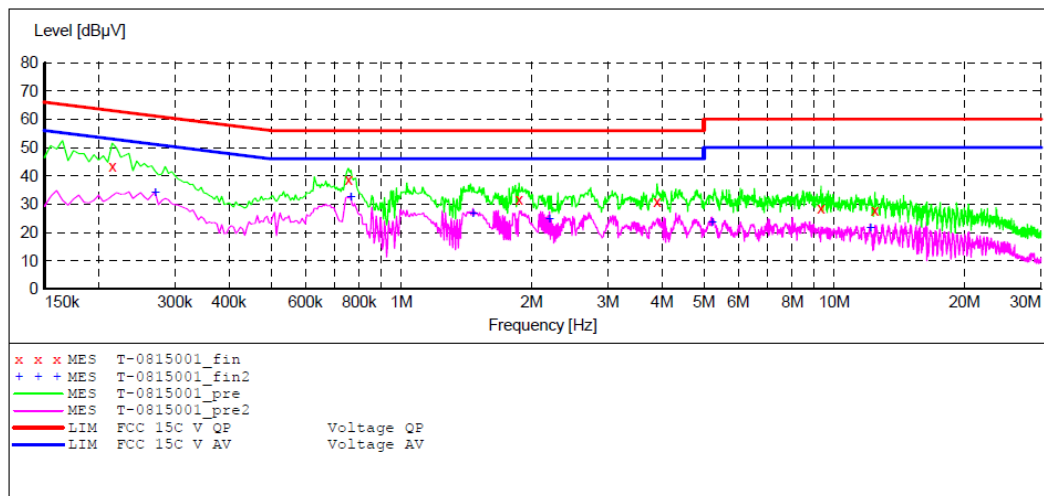

MEASUREMENT RESULT: "T-0815001_fin"

8/15/2018 9:56AM

Frequency MHz	Level dBµV	Transd dB	Limit dBµV	Margin dB	Detector	Line	PE
0.215000	43.40	10.5	63	19.6	QP	L1	GND
0.755000	38.50	10.8	56	17.5	QP	L1	GND
1.870000	31.80	11.0	56	24.2	QP	L1	GND
3.900000	30.90	11.1	56	25.1	QP	L1	GND
9.320000	28.40	11.3	60	31.6	QP	L1	GND
12.415000	27.70	11.3	60	32.3	QP	L1	GND

MEASUREMENT RESULT: "T-0815001_fin2"

8/15/2018 9:56AM

Frequency MHz	Level dBµV	Transd dB	Limit dBµV	Margin dB	Detector	Line	PE
0.270000	33.90	10.6	51	17.2	AV	L1	GND
0.765000	32.40	10.8	46	13.6	AV	L1	GND
1.465000	26.60	10.9	46	19.4	AV	L1	GND
2.200000	24.80	11.0	46	21.2	AV	L1	GND
5.220000	23.30	11.2	50	26.7	AV	L1	GND
12.115000	21.40	11.3	50	28.6	AV	L1	GND

ACCURATE TECHNOLOGY CO., LTD

CONDUCTED EMISSION STANDARD FCC PART 15 C

EUT: ESL accesspoint M/N:SMARTAP 320
 Manufacturer: SES-inagotag Deutschland GmbH
 Operating Condition: Wireless communication
 Test Site: 1#Shielding Room
 Operator: star
 Test Specification: N 120V/60Hz
 Comment: Report No.: ATE20181306
 Start of Test: 8/15/2018 / 9:57:01AM

SCAN TABLE: "V 9K-30MHz fin"

Start	Stop	Step	Detector	Meas. Time	IF Bandw.	Transducer
9.0 kHz	150.0 kHz	100.0 Hz	QuasiPeak	1.0 s	200 Hz	NSLK8126 2008
150.0 kHz	30.0 MHz	5.0 kHz	Average			
			QuasiPeak	1.0 s	9 kHz	NSLK8126 2008
			Average			

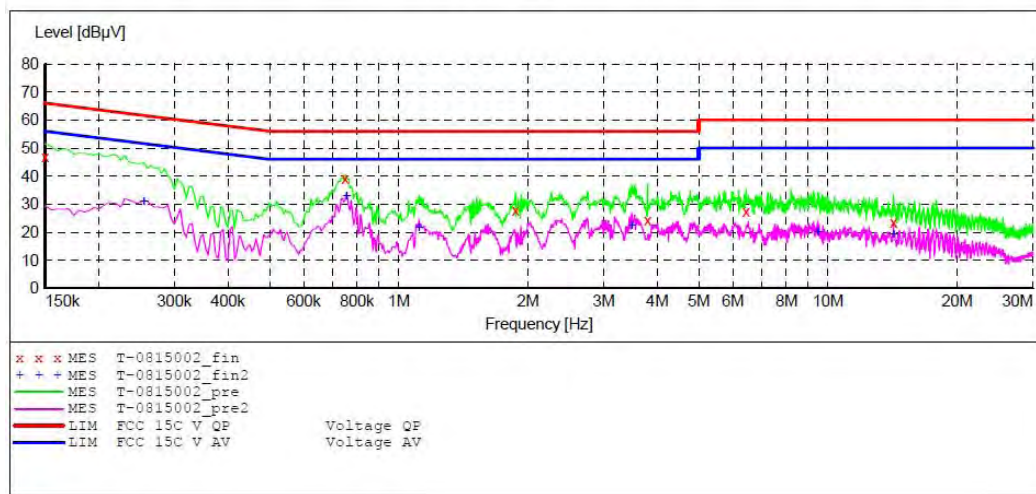

MEASUREMENT RESULT: "T-0815002_fin"

8/15/2018 10:00AM

Frequency MHz	Level dBµV	Transd dB	Limit dBµV	Margin dB	Detector	Line	PE
0.150000	47.00	10.5	66	19.0	QP	N	GND
0.750000	39.00	10.8	56	17.0	QP	N	GND
1.870000	27.60	11.0	56	28.4	QP	N	GND
3.800000	24.30	11.1	56	31.7	QP	N	GND
6.440000	27.50	11.2	60	32.5	QP	N	GND
14.215000	23.50	11.4	60	36.5	QP	N	GND

MEASUREMENT RESULT: "T-0815002_fin2"

8/15/2018 10:00AM

Frequency MHz	Level dBµV	Transd dB	Limit dBµV	Margin dB	Detector	Line	PE
0.255000	30.80	10.6	52	20.8	AV	N	GND
0.755000	32.90	10.8	46	13.1	AV	N	GND
1.115000	21.70	10.9	46	24.3	AV	N	GND
3.490000	22.30	11.1	46	23.7	AV	N	GND
9.470000	20.00	11.3	50	30.0	AV	N	GND
14.215000	19.40	11.4	50	30.6	AV	N	GND

ACCURATE TECHNOLOGY CO., LTD

CONDUCTED EMISSION STANDARD FCC PART 15 C

EUT: ESL accesspoint M/N:SMARTAP 320
 Manufacturer: SES-inagotag Deutschland GmbH
 Operating Condition: Wireless communication
 Test Site: 1#Shielding Room
 Operator: star
 Test Specification: N 240V/60Hz
 Comment: Report No.: ATE20181306
 Start of Test: 8/15/2018 / 10:01:31AM

SCAN TABLE: "V 9K-30MHz fin"

Start	Stop	Step	Detector	Meas. Time	IF Bandw.	Transducer
9.0 kHz	150.0 kHz	100.0 Hz	QuasiPeak	1.0 s	200 Hz	NSLK8126 2008
150.0 kHz	30.0 MHz	5.0 kHz	Average			
			QuasiPeak	1.0 s	9 kHz	NSLK8126 2008
			Average			

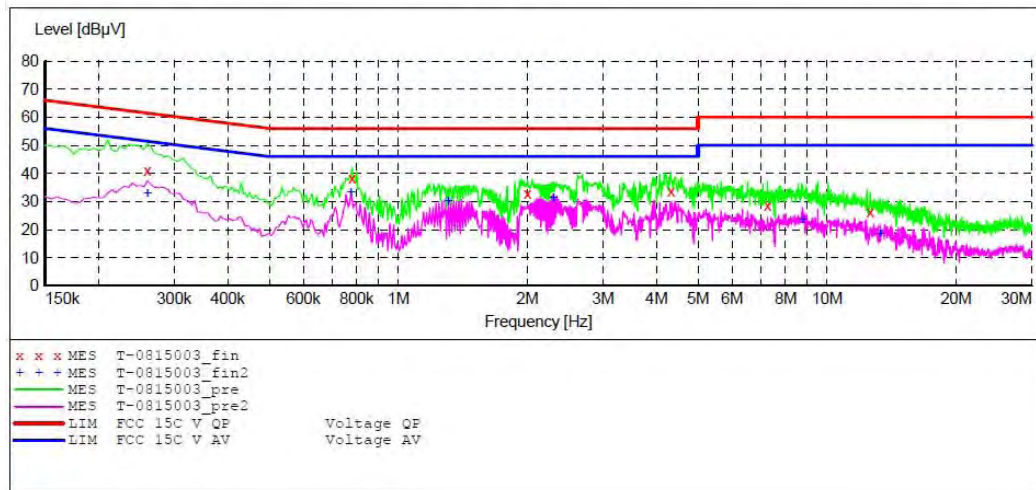

MEASUREMENT RESULT: "T-0815003_fin"

8/15/2018 10:04AM

Frequency MHz	Level dBµV	Transd dB	Limit dBµV	Margin dB	Detector	Line	PE
0.260000	40.90	10.6	61	20.5	QP	N	GND
0.780000	38.10	10.8	56	17.9	QP	N	GND
2.000000	33.00	11.0	56	23.0	QP	N	GND
4.320000	33.70	11.1	56	22.3	QP	N	GND
7.260000	28.40	11.2	60	31.6	QP	N	GND
12.595000	26.40	11.3	60	33.6	QP	N	GND

MEASUREMENT RESULT: "T-0815003_fin2"

8/15/2018 10:04AM

Frequency MHz	Level dBµV	Transd dB	Limit dBµV	Margin dB	Detector	Line	PE
0.260000	33.00	10.6	51	18.4	AV	N	GND
0.775000	33.20	10.8	46	12.8	AV	N	GND
1.305000	30.10	10.9	46	15.9	AV	N	GND
2.300000	31.30	11.0	46	14.7	AV	N	GND
8.770000	23.60	11.3	50	26.4	AV	N	GND
13.285000	18.30	11.3	50	31.7	AV	N	GND

ACCURATE TECHNOLOGY CO., LTD

CONDUCTED EMISSION STANDARD FCC PART 15 C

EUT: ESL accesspoint M/N:SMARTAP 320
 Manufacturer: SES-inagotag Deutschland GmbH
 Operating Condition: Wireless communication
 Test Site: 1#Shielding Room
 Operator: star
 Test Specification: L 240V/60Hz
 Comment: Report No.: ATE20181306
 Start of Test: 8/15/2018 / 10:05:22AM

SCAN TABLE: "V 9K-30MHz fin"

Start	Stop	Step	Detector	Meas. Time	IF Bandw.	Transducer
9.0 kHz	150.0 kHz	100.0 Hz	QuasiPeak	1.0 s	200 Hz	NSLK8126 2008
Average						
150.0 kHz	30.0 MHz	5.0 kHz	QuasiPeak	1.0 s	9 kHz	NSLK8126 2008
Average						

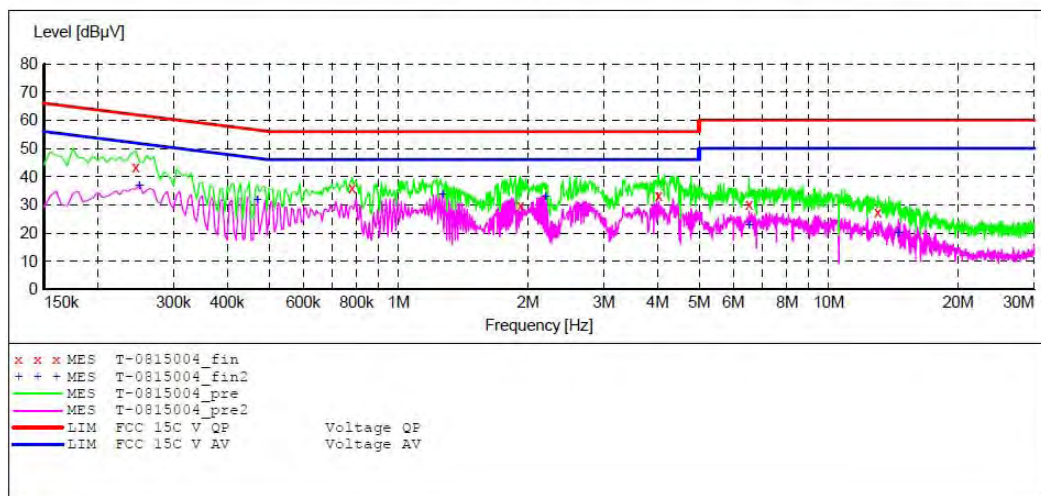

MEASUREMENT RESULT: "T-0815004_fin"

8/15/2018 10:08AM

Frequency MHz	Level dBuV	Transd dB	Limit dBuV	Margin dB	Detector	Line	PE
0.245000	43.40	10.6	62	18.5	QP	L1	GND
0.780000	36.10	10.8	56	19.9	QP	L1	GND
1.920000	29.60	11.0	56	26.4	QP	L1	GND
4.020000	33.20	11.1	56	22.8	QP	L1	GND
6.530000	30.10	11.2	60	29.9	QP	L1	GND
13.000000	27.40	11.3	60	32.6	QP	L1	GND

MEASUREMENT RESULT: "T-0815004_fin2"

8/15/2018 10:08AM

Frequency MHz	Level dBuV	Transd dB	Limit dBuV	Margin dB	Detector	Line	PE
0.250000	36.80	10.6	52	15.0	AV	L1	GND
0.470000	31.70	10.7	47	14.8	AV	L1	GND
1.265000	33.60	10.9	46	12.4	AV	L1	GND
2.200000	32.80	11.0	46	13.2	AV	L1	GND
6.530000	22.80	11.2	50	27.2	AV	L1	GND
14.530000	20.10	11.4	50	29.9	AV	L1	GND

6. 6DB BANDWIDTH MEASUREMENT

6.1. Block Diagram of Test Setup

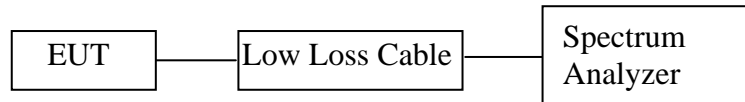

6.2. The Requirement For Section 15.247(a)(2)

Section 15.247(a)(2): Systems using digital modulation techniques may operate in the 902-928MHz, 2400-2483.5MHz, and 5725-5850MHz bands. The minimum 6 dB bandwidth shall be at least 500 kHz.

6.3. EUT Configuration on Measurement

The equipment are installed on the emission measurement to meet the commission requirements and operating regulations in a manner which tends to maximize its emission characteristics in normal application.

6.4. Operating Condition of EUT

6.4.1. Setup the EUT and simulator as shown as Section 6.1.

6.4.2. Turn on the power of all equipment.

6.4.3. Let the EUT work in TX modes measure it. The transmit frequency are 903.375-926.475MHz. We select 903.375MHz, 914.375MHz, 926.475MHz TX frequency to transmit.

6.5. Test Procedure

1. Set resolution bandwidth (RBW) = 100 kHz.
2. Set the video bandwidth (VBW) $\geq 3 \times$ RBW.
3. Detector = Peak.
4. Trace mode = max hold.
5. Sweep = auto couple.
6. Allow the trace to stabilize.
7. Measure the maximum width of the emission that is constrained by the frequencies associated with the two outermost amplitude points (upper and lower) that are attenuated by 6 dB relative to the maximum level measured in the fundamental emission.

6.6. Test Result

Test Lab: Shielding room

Test Engineer: Star

Channel	Frequency (MHz)	6dB Bandwidth (MHz)	Limit (MHz)	Result
Low	903.375	0.570	> 0.5MHz	Pass
Middle	914.375	0.567	> 0.5MHz	Pass
High	926.475	0.567	> 0.5MHz	Pass

The spectrum analyzer plots are attached as below.

Low Channel

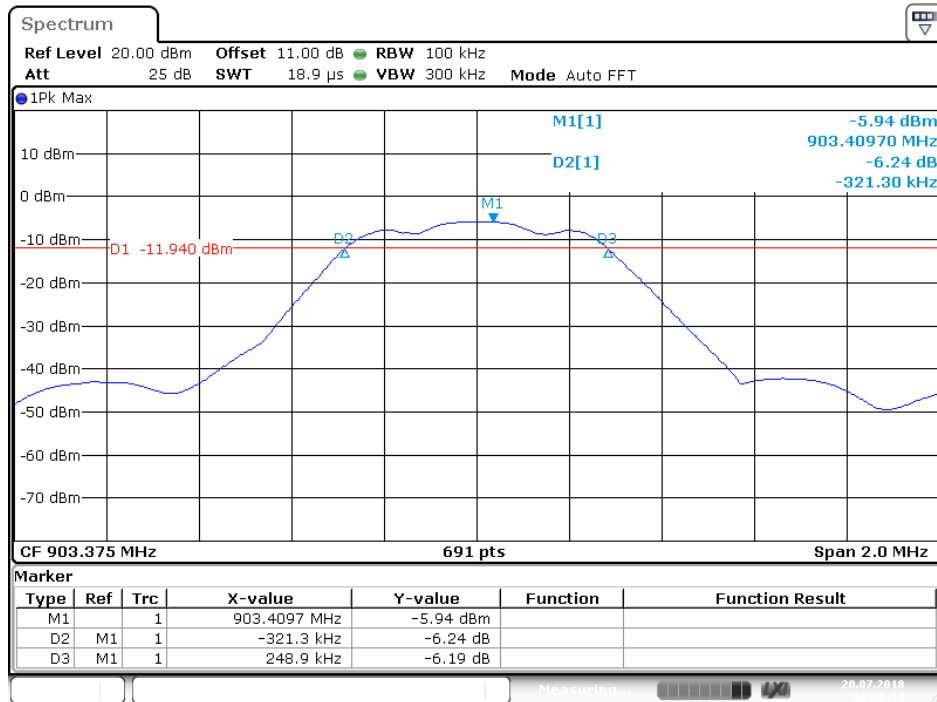

Date: 20.JUL.2018 10:06:15

Middle Channel

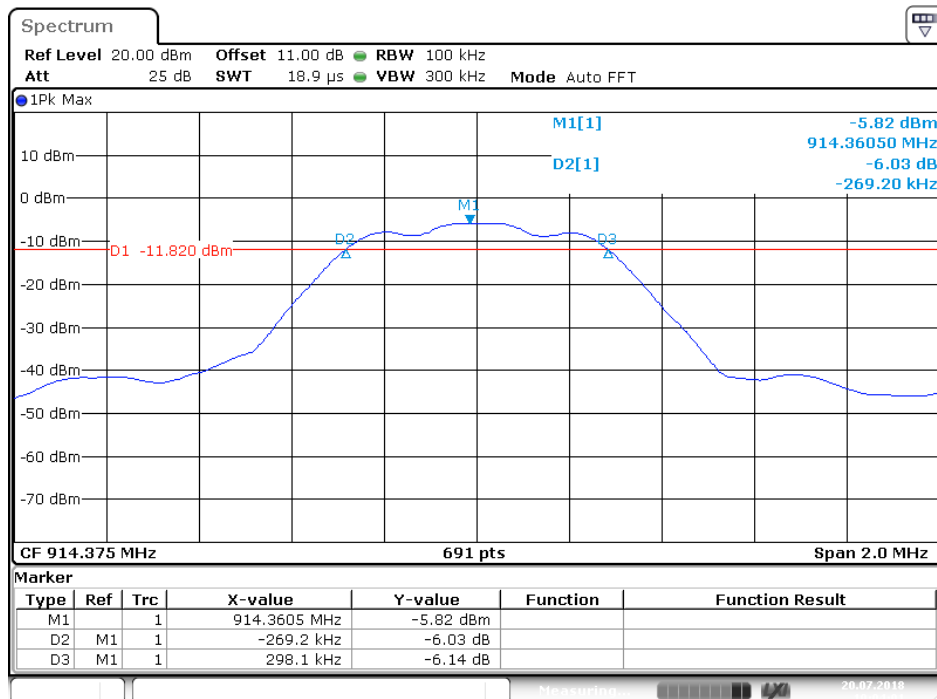

Date: 20.JUL.2018 10:04:02

High Channel

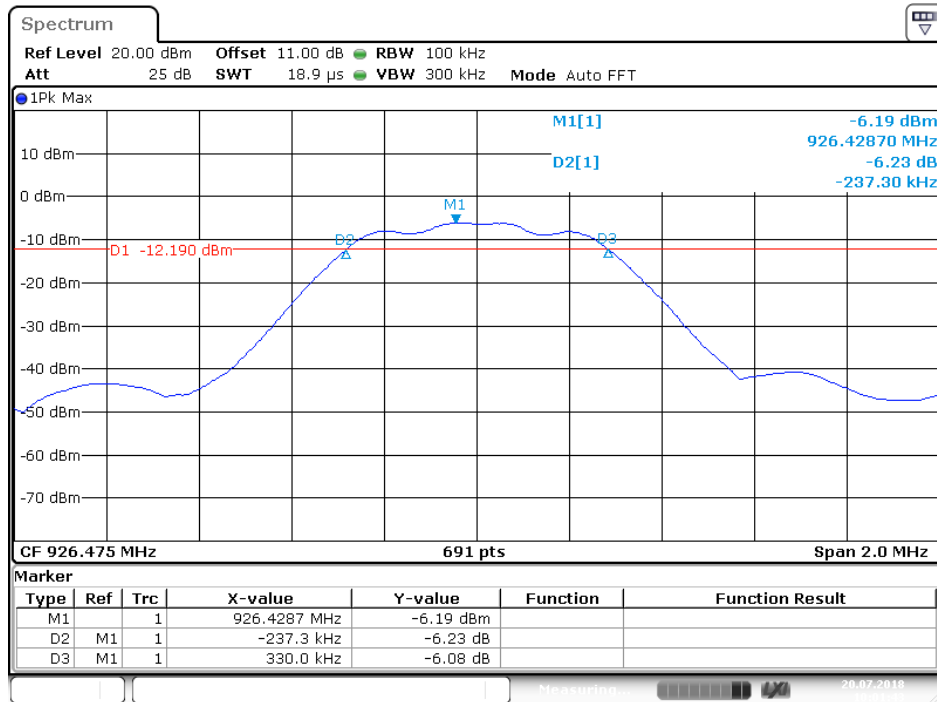

Date: 20.JUL.2018 10:01:44

7. MAXIMUM PEAK OUTPUT POWER

7.1. Block Diagram of Test Setup

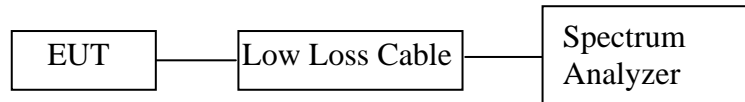

7.2. The Requirement For Section 15.247(b)(3)

Section 15.247(b)(3): For systems using digital modulation in the 902-928MHz, 2400-2483.5MHz, and 5725-5850MHz bands: 1 Watt.

7.3. EUT Configuration on Measurement

The equipment is installed on the emission Measurement to meet the commission requirements and operating regulations in a manner which tends to maximize its emission characteristics in normal application.

7.4. Operating Condition of EUT

7.4.1. Setup the EUT and simulator as shown as Section 7.1.

7.4.2. Turn on the power of all equipment.

7.4.3. Let the EUT work in TX modes measure it. The transmit frequency are 903.375-926.475MHz. We select 903.375MHz, 914.375MHz, 926.475MHz TX frequency to transmit.

7.5. Test Procedure

7.5.1. The transmitter output was connected to the spectrum analyzer through a low loss cable.

7.5.2. Set RBW of spectrum analyzer to 1 MHz and VBW to 3MHz.

7.5.3. Measurement the maximum peak output power.

7.6. Test Result

Test Lab: Shielding room
Test Engineer: Star

Channel	Frequency (MHz)	Peak Power Output (dBm)	Peak Power Limit (dBm)	Result
Low	903.375	-4.99	30	Pass
Middle	914.375	-4.99	30	Pass
High	926.475	-5.22	30	Pass

The spectrum analyzer plots are attached as below.

Low Channel

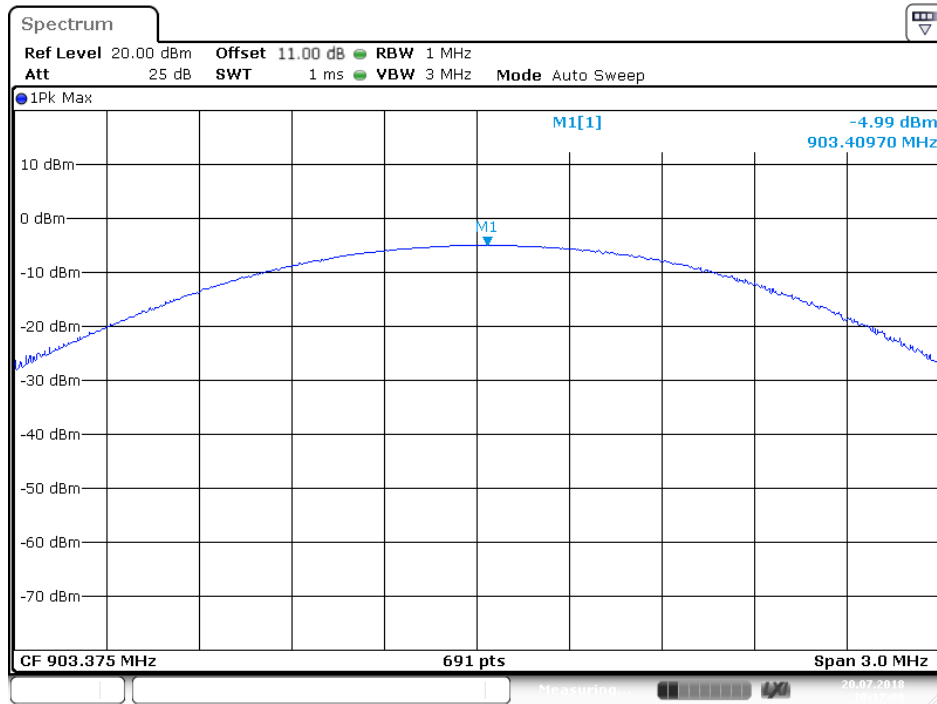

Date: 20.JUL.2018 10:17:10

Middle Channel

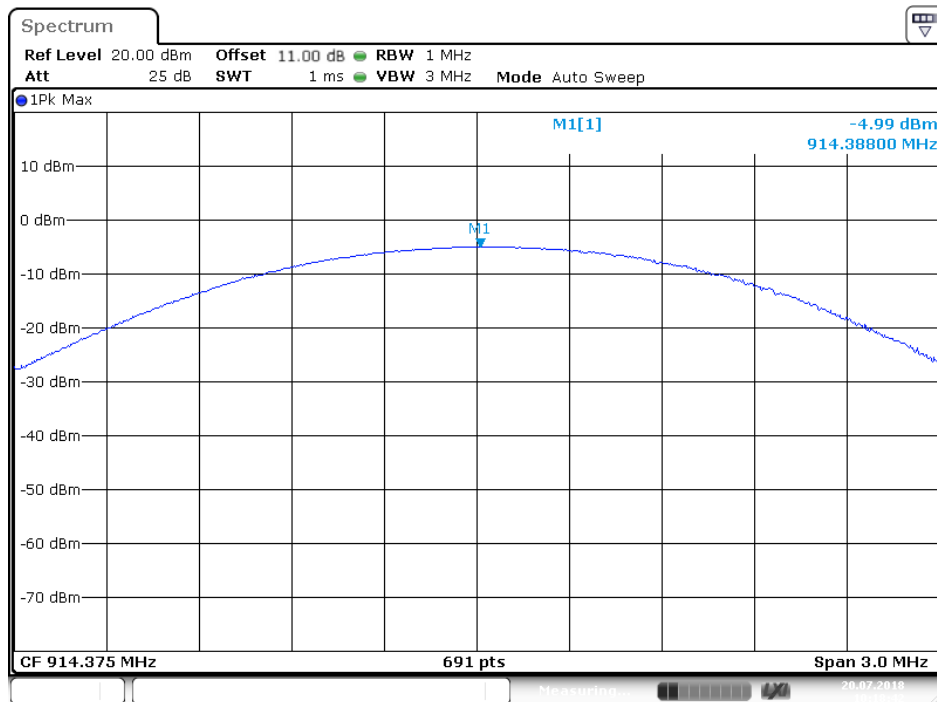

Date: 20.JUL.2018 10:18:43

High Channel

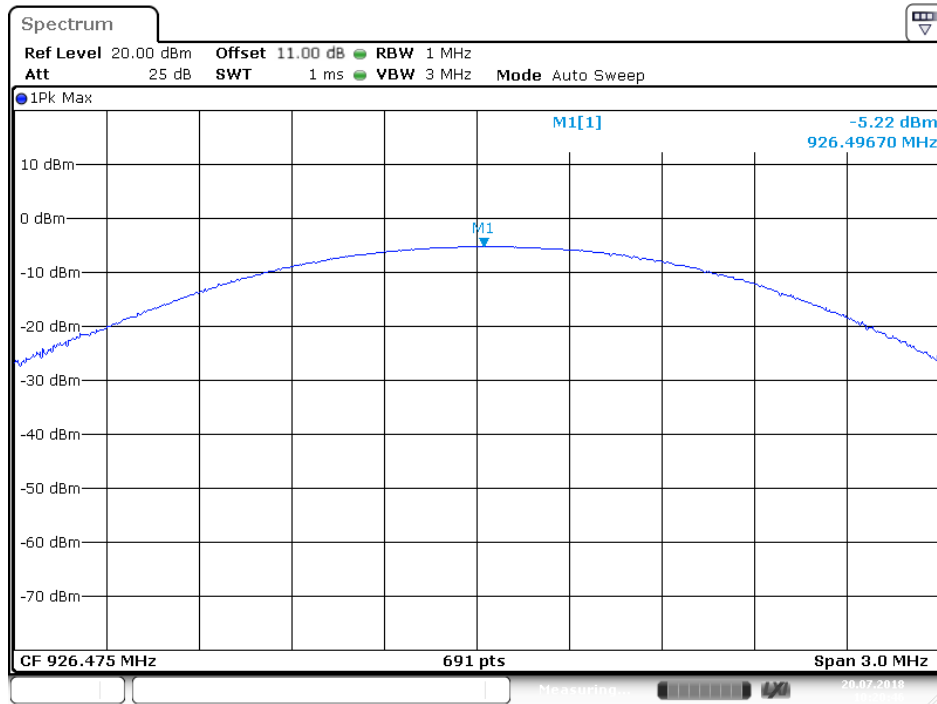

Date: 20.JUL.2018 10:20:47

8. POWER SPECTRAL DENSITY MEASUREMENT

8.1. Block Diagram of Test Setup

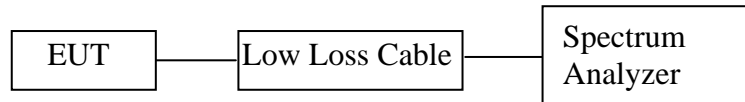

8.2. The Requirement For Section 15.247(e)

Section 15.247(e): For digitally modulated systems, the power spectral density conducted from the intentional radiator to the antenna shall not be greater than 8 dBm in any 3 kHz band during any time interval of continuous transmission.

8.3. EUT Configuration on Measurement

The equipment are installed on the emission Measurement to meet the commission requirements and operating regulations in a manner which tends to maximize its emission characteristics in normal application.

8.4. Operating Condition of EUT

8.4.1. Setup the EUT and simulator as shown as Section 9.1.

8.4.2. Turn on the power of all equipment.

8.4.3. Let the EUT work in TX modes measure it. The transmit frequency are 903.375-926.475MHz. We select 903.375MHz, 914.375MHz, 926.475MHz TX frequency to transmit.

8.5. Test Procedure

8.5.1. The transmitter output was connected to the spectrum analyzer through a low loss cable.

8.5.2. Measurement Procedure PKPSD:

8.5.3. This procedure must be used if maximum peak conducted output power was used to demonstrate compliance to the fundamental output power limit, and is optional if the maximum (average) conducted output power was used to demonstrate compliance.

1. Set analyzer center frequency to DTS channel center frequency.
2. Set the span to 1.5 times the DTS channel bandwidth.
3. Set the RBW to: $3 \text{ kHz} \leq \text{RBW} \leq 100 \text{ kHz}$.
4. Set the VBW $\geq 3 \times \text{RBW}$.
5. Detector = peak.
6. Sweep time = auto couple.
7. Trace mode = max hold.
8. Allow trace to fully stabilize.
9. Use the peak marker function to determine the maximum amplitude level.
10. If measured value exceeds limit, reduce RBW (no less than 3kHz) and repeat.

8.5.4. Measurement the maximum power spectral density.

8.6. Test Result

Test Lab: Shielding room
Test Engineer: Star

Channel	Frequency (MHz)	PSD (dBm/3KHz)	Limit (dBm/3KHz)	Result
Low	903.375	-18.44	8	Pass
Middle	914.375	-18.35	8	Pass
High	926.475	-18.61	8	Pass

The spectrum analyzer plots are attached as below.

Low Channel

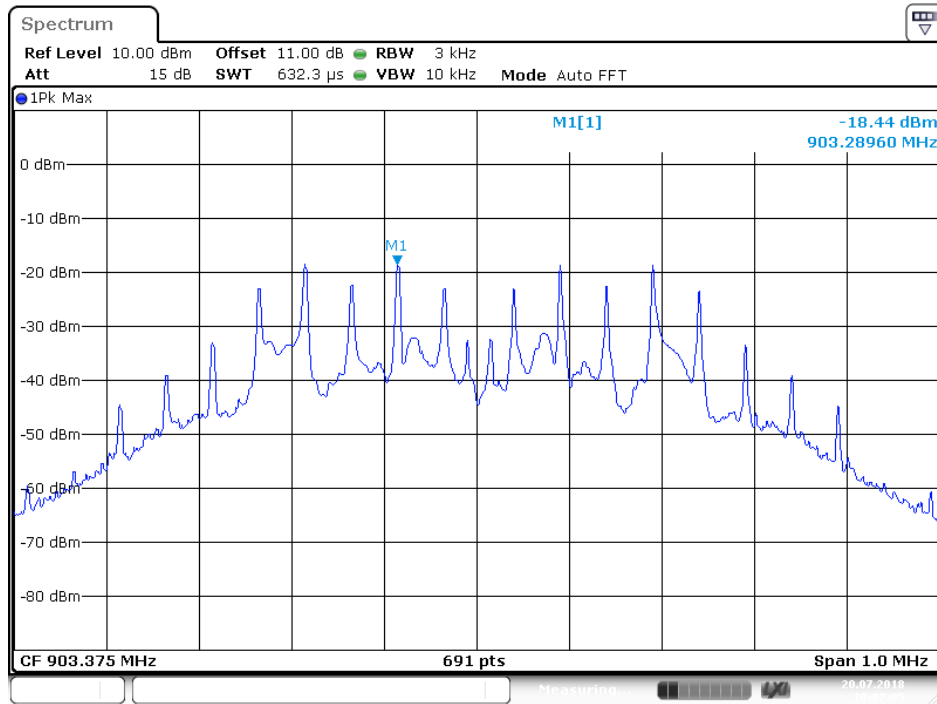

Date: 20.JUL.2018 10:07:06

Middle Channel

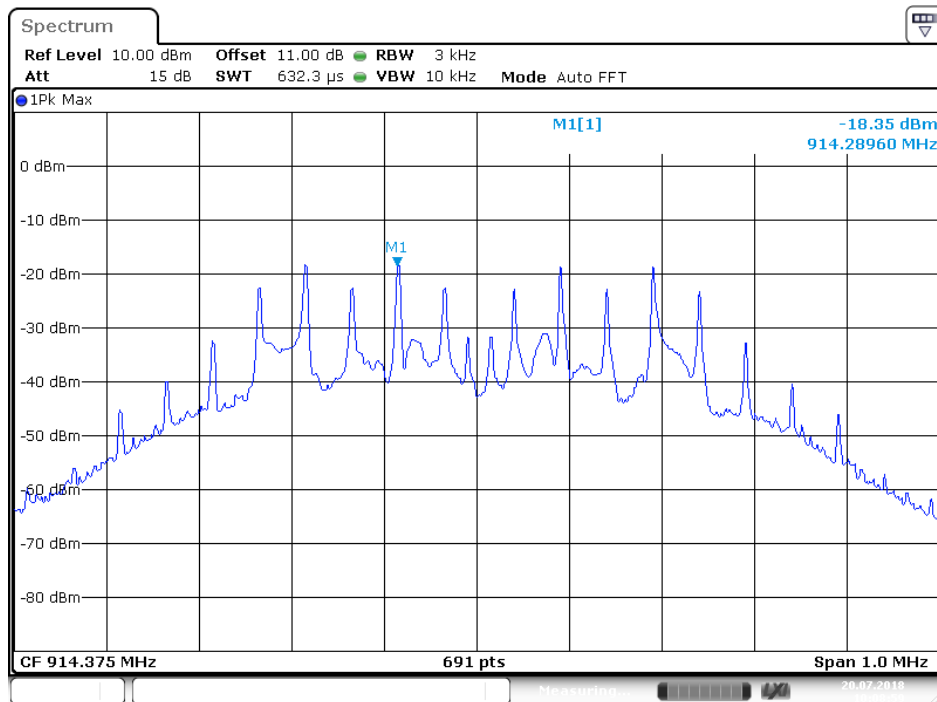

Date: 20.JUL.2018 10:09:00

High Channel

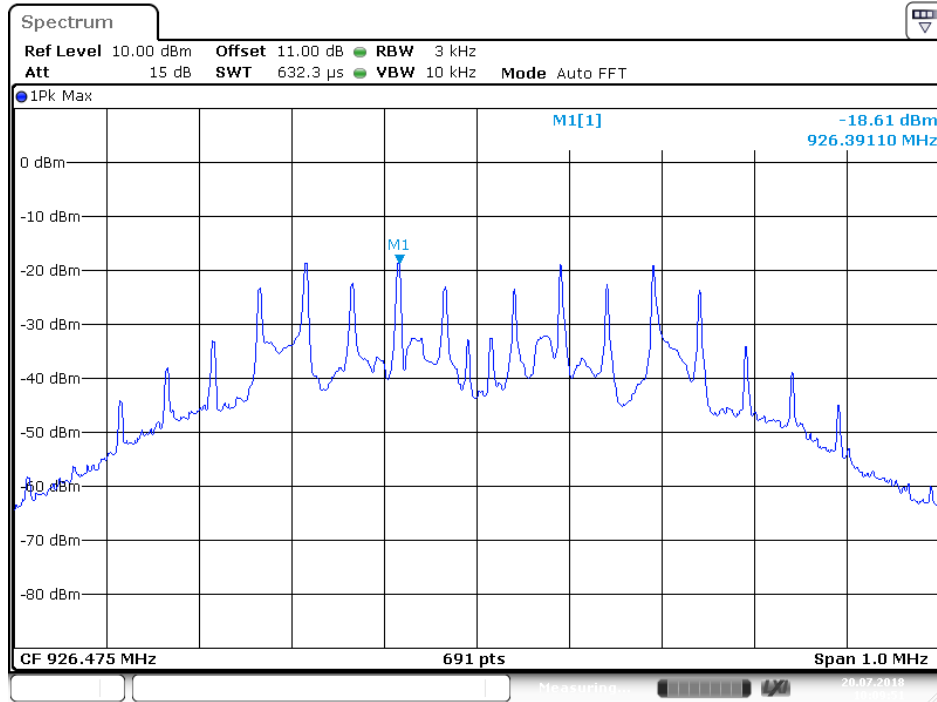

Date: 20.JUL.2018 10:09:51

9. BAND EDGE COMPLIANCE TEST

9.1. Block Diagram of Test Setup

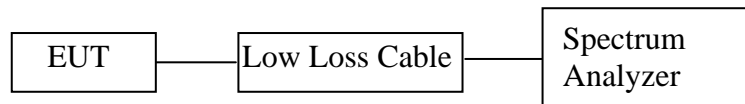

9.2. The Requirement For Section 15.247(d)

Section 15.247(d): In any 100 kHz bandwidth outside the frequency band in which the spread spectrum or digitally modulated intentional radiator is operating, the radio frequency power that is produced by the intentional radiator shall be at least 20 dB below that in the 100 kHz bandwidth within the band that contains the highest level of the desired power, based on either an RF conducted or a radiated measurement, provided the transmitter demonstrates compliance with the peak conducted power limits. If the transmitter complies with the conducted power limits based on the use of RMS averaging over a time interval, as permitted under paragraph (b)(3) of this section, the attenuation required under this paragraph shall be 30 dB instead of 20 dB. Attenuation below the general limits specified in Section 15.209(a) is not required. In addition, radiated emissions which fall in the restricted bands, as defined in Section 15.205(a), must also comply with the radiated emission limits specified in Section 15.209(a).

9.3. EUT Configuration on Measurement

The equipment are installed on the emission Measurement to meet the commission requirements and operating regulations in a manner which tends to maximize its emission characteristics in normal application.

9.4. Operating Condition of EUT

9.4.1. Setup the EUT and simulator as shown as Section 9.1.

9.4.2. Turn on the power of all equipment.

9.4.3. Let the EUT work in TX modes measure it. The transmit frequency are 903.375-926.475MHz. We select 903.375MHz, 926.475MHz TX frequency to transmit.

9.5. Test Procedure

Conducted Band Edge:

9.5.1. The transmitter output was connected to the spectrum analyzer via a low loss cable.

9.5.2. Set RBW of spectrum analyzer to 100kHz and VBW to 300kHz.

Radiate Band Edge:

9.5.1. The EUT is placed on a turntable, which is 1.5m above the ground plane and worked at highest radiated power.

9.5.2. The turntable was rotated for 360 degrees to determine the position of maximum emission level.

9.5.3. EUT is set 3m away from the receiving antenna, which is varied from 1m to 4m to find out the highest emission.

9.5.4. Set the spectrum analyzer in the following setting in order to capture the lower and upper band-edges of the emission:

9.5.5. RBW=1MHz, VBW=1MHz

9.5.6. The band edges was measured and recorded.

9.6. Test Result

Test Lab: Shielding room

Test Engineer: Star

Frequency (MHz)	Delta peak to band emission	Limit of Band Edge (dBc)	Result
902	52.15	> 20	Pass
928	46.14	> 20	Pass

The spectrum analyzer plots are attached as below.

Low Channel

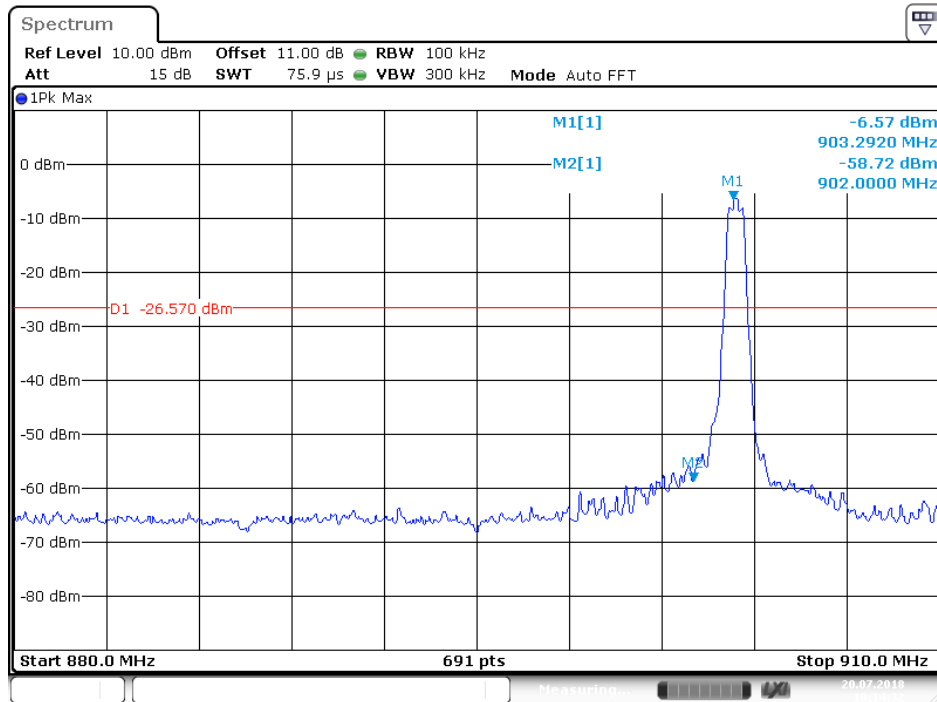

High Channel

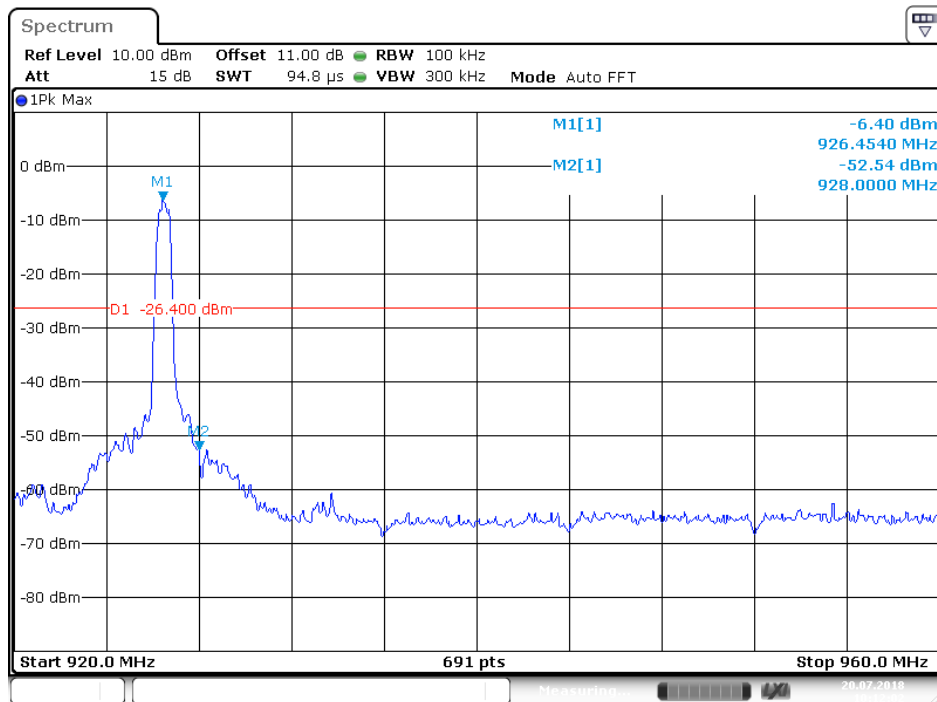

Radiated Band Edge Result

Note:

1. Emissions attenuated more than 20 dB below the permissible value are not reported.
2. The field strength is calculated by adding the antenna factor, high pass filter loss(if used) and cable loss, and subtracting the amplifier gain(if any)from the measured reading. The basic equation calculation is as follows:
Result = Reading + Corrected Factor
3. Display the measurement of peak values.

Test Procedure:

The EUT and its simulators are placed on a turntable, which is 1.5 meter high above ground(Above 1GHz). The turntable can rotate 360 degrees to determine the position of the maximum emission level. EUT is set 3.0 meters away from the receiving antenna, which is mounted on an antenna tower. The antenna can be moved up and down between 1.0 meter and 4 meters to find out the maximum emission level. Broadband antenna (calibrated bi-log antenna) is used as receiving antenna. Both horizontal and vertical polarizations of the antenna are set on measurement. In order to find the maximum emission levels, all of the EUT location must be manipulated according to ANSI C63.10:2013 on radiated emission measurement. This EUT was tested in 3 orthogonal positions and the worst case position data was reported.

Let the EUT work in TX modes then measure it.
We select 903.375MHz, 926.475MHz TX frequency to transmit.

During the radiated emission test, the spectrum analyzer was set with the following configurations:

- 1.The resolution bandwidth of test receiver/spectrum analyzer is 1MHz and video bandwidth is 3MHz for peak measurement with peak detector at frequency above 1GHz.
- 2.The resolution bandwidth of test receiver/spectrum analyzer is 1MHz and video bandwidth is 10Hz for Average measurement with peak detection at frequency above 1GHz.

Test Lab: 3m Anechoic chamber
Test Engineer: Star

The spectrum analyzer plots are attached as below.



ACCURATE TECHNOLOGY CO., LTD.

F1,Bldg,A,Changyuan New Material Port Keyuan Rd,
Science & Industry Park,Nanshan Shenzhen,P.R.China

Site: 2# Chamber
Tel:+86-0755-26503290
Fax:+86-0755-26503396

Job No.: STAR2016 #2723	Polarization: Horizontal
Standard: FCC PART 15C 3M Radiated	Power Source: AC 120V/60Hz
Test item: Radiation Test	Date: 18/08/13/
Temp.(C)/Hum.(%) 23 C / 48 %	Time: 11/53/51
EUT: ESL accesspoint	Engineer Signature: star
Mode: TX 903.375MHz	Distance: 3m
Model: SMARTAP 320	
Manufacturer: SES-inagotag Deutschland GmbH	

Note: Report No.: ATE20181306



No.	Freq. (MHz)	Reading (dBuV/m)	Factor (dB)	Result (dBuV/m)	Limit (dBuV/m)	Margin (dB)	Detector	Height (cm)	Degree (deg.)	Remark
1	902.0000	27.30	2.18	29.48	46.00	-16.52	QP	200	147	



ACCURATE TECHNOLOGY CO., LTD.

F1,Bldg,A,Changyuan New Material Port Keyuan Rd,
Science & Industry Park,Nanshan Shenzhen,P.R.China

Site: 2# Chamber
Tel:+86-0755-26503290
Fax:+86-0755-26503396

Job No.: STAR2016 #2722	Polarization: Vertical
Standard: FCC PART 15C 3M Radiated	Power Source: AC 120V/60Hz
Test item: Radiation Test	Date: 18/08/13/
Temp.(C)/Hum.(%) 23 C / 48 %	Time: 11/52/57
EUT: ESL accesspoint	Engineer Signature: star
Mode: TX 903.375MHz	Distance: 3m
Model: SMARTAP 320	
Manufacturer: SES-inagotag Deutschland GmbH	

Note: Report No.: ATE20181306

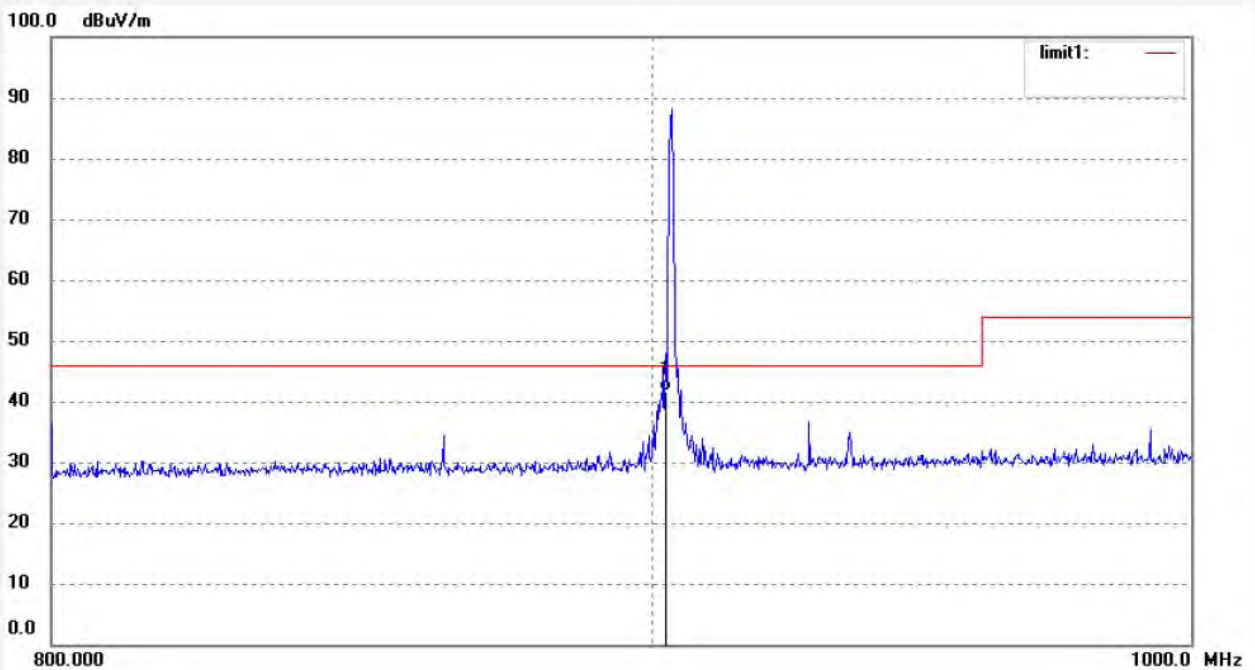

No.	Freq. (MHz)	Reading (dBuV/m)	Factor (dB)	Result (dBuV/m)	Limit (dBuV/m)	Margin (dB)	Detector	Height (cm)	Degree (deg.)	Remark
1	902.0000	39.50	2.18	41.68	46.00	-4.32	QP	100	101	



ACCURATE TECHNOLOGY CO., LTD.

F1,Bldg,A,Changyuan New Material Port Keyuan Rd,
Science & Industry Park,Nanshan Shenzhen,P.R.China

Site: 2# Chamber
Tel:+86-0755-26503290
Fax:+86-0755-26503396

Job No.: STAR2016 #2720	Polarization: Horizontal
Standard: FCC PART 15C 3M Radiated	Power Source: AC 120V/60Hz
Test item: Radiation Test	Date: 18/08/13/
Temp.(C)/Hum.(%) 23 C / 48 %	Time: 11/50/03
EUT: ESL accesspoint	Engineer Signature: star
Mode: TX 926.475MHz	Distance: 3m
Model: SMARTAP 320	
Manufacturer: SES-inagotag Deutschland GmbH	

Note: Report No.: ATE20181306

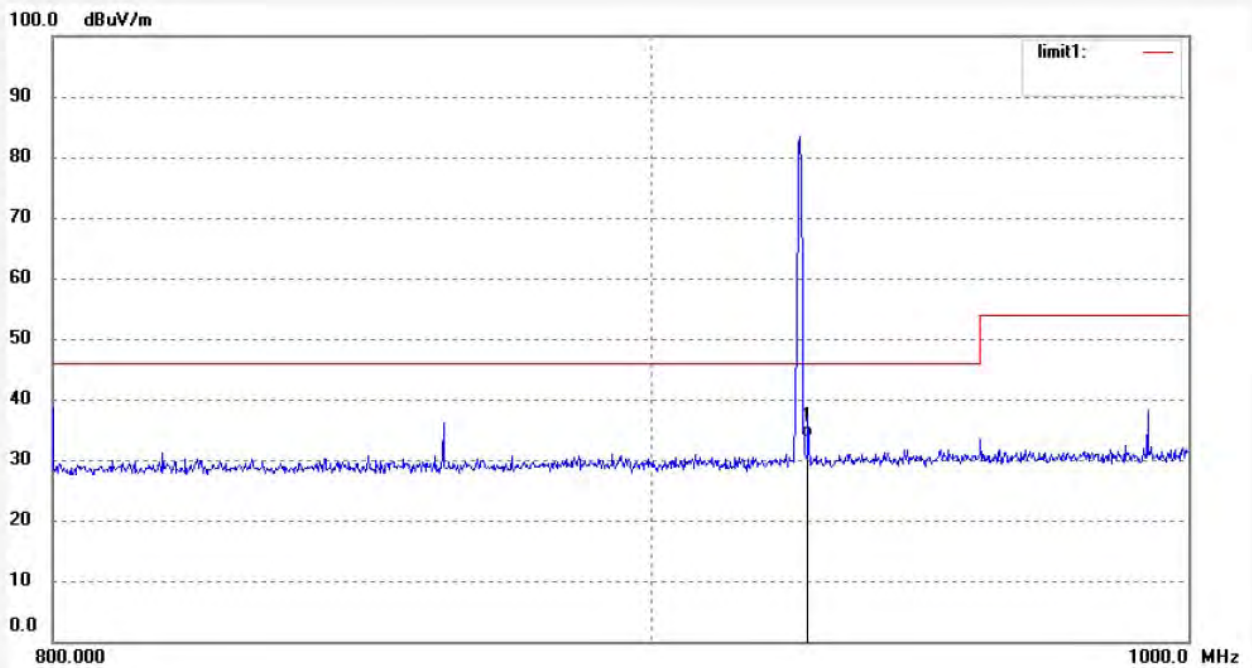

No.	Freq. (MHz)	Reading (dBuV/m)	Factor (dB)	Result (dBuV/m)	Limit (dBuV/m)	Margin (dB)	Detector	Height (cm)	Degree (deg.)	Remark
1	928.0000	31.00	2.73	33.73	46.00	-12.27	QP	200	292	



ACCURATE TECHNOLOGY CO., LTD.

F1,Bldg,A,Changyuan New Material Port Keyuan Rd,
Science & Industry Park,Nanshan Shenzhen,P.R.China

Site: 2# Chamber
Tel:+86-0755-26503290
Fax:+86-0755-26503396

Job No.: STAR2016 #2721	Polarization: Vertical
Standard: FCC PART 15C 3M Radiated	Power Source: AC 120V/60Hz
Test item: Radiation Test	Date: 18/08/13/
Temp.(C)/Hum.(%) 23 C / 48 %	Time: 11/51/02
EUT: ESL accesspoint	Engineer Signature: star
Mode: TX 926.475MHz	Distance: 3m
Model: SMARTAP 320	
Manufacturer: SES-inagotag Deutschland GmbH	

Note: Report No.: ATE20181306

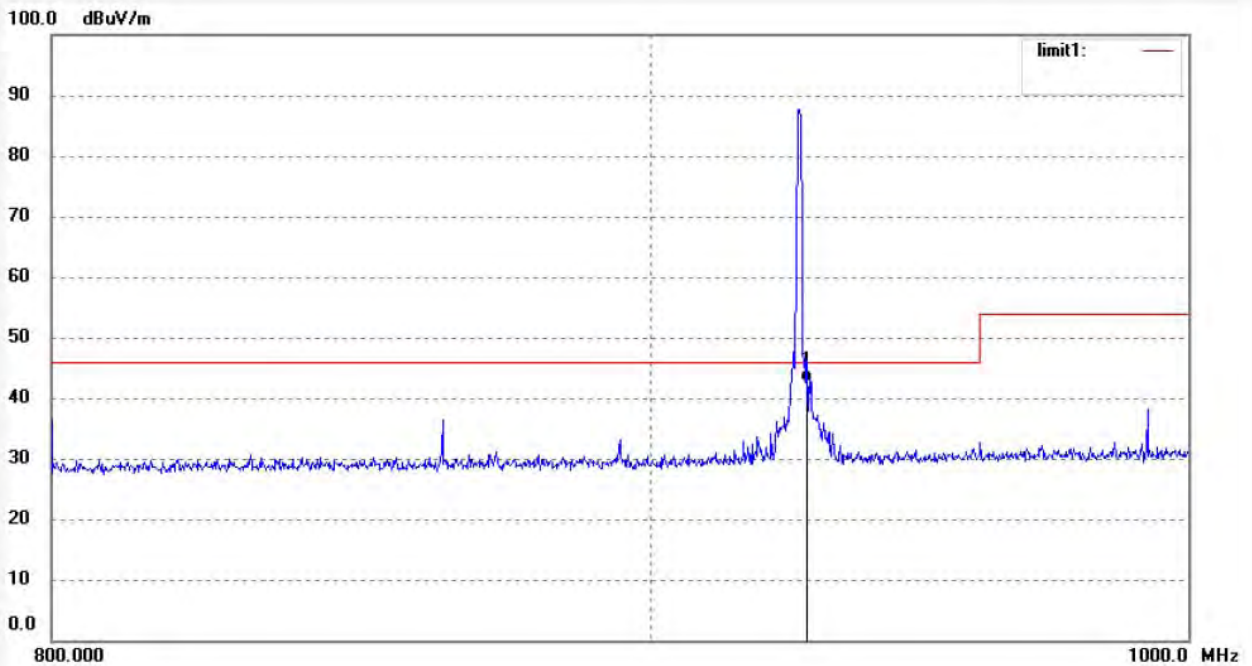

No.	Freq. (MHz)	Reading (dBuV/m)	Factor (dB)	Result (dBuV/m)	Limit (dBuV/m)	Margin (dB)	Detector	Height (cm)	Degree (deg.)	Remark
1	928.0000	40.00	2.73	42.73	46.00	-3.27	QP	100	218	

10.RADIATED SPURIOUS EMISSION TEST

10.1.Block Diagram of Test Setup

10.1.1.Block diagram of connection between the EUT and peripherals

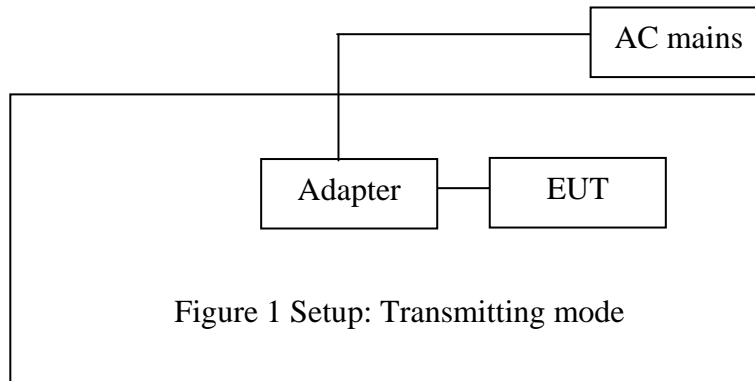

10.1.2.Semi-Anechoic Chamber Test Setup Diagram

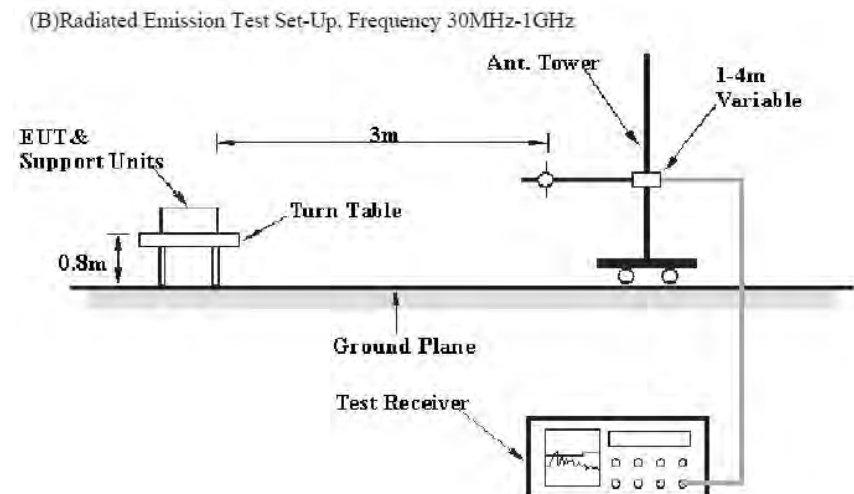
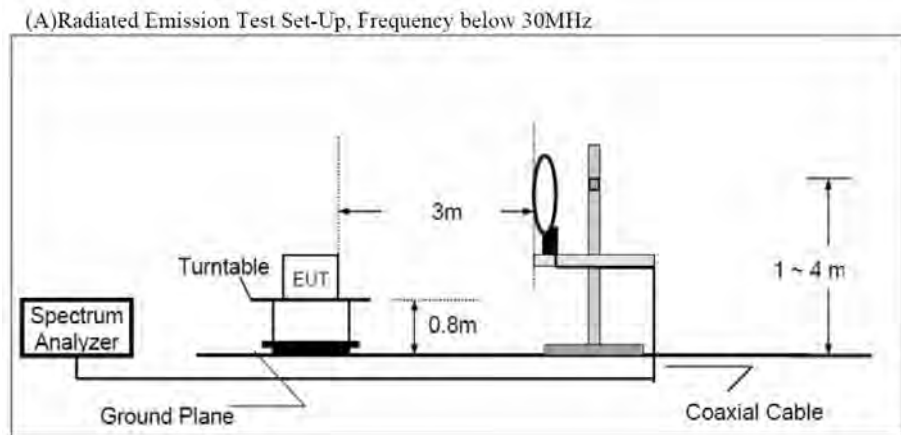

(C) Radiated Emission Test Set-Up. Frequency above 1GHz

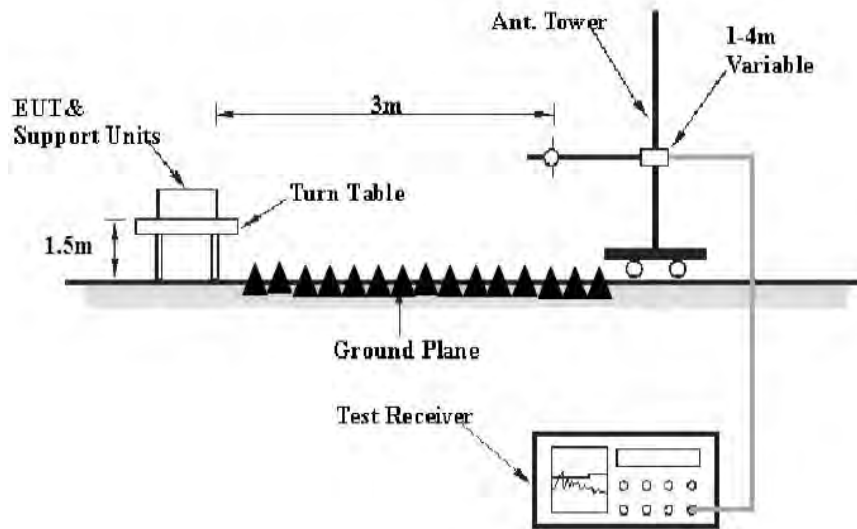

10.2. The Limit For Section 15.247(d)

Section 15.247(d): In any 100 kHz bandwidth outside the frequency band in which the spread spectrum or digitally modulated intentional radiator is operating, the radio frequency power that is produced by the intentional radiator shall be at least 20 dB below that in the 100 kHz bandwidth within the band that contains the highest level of the desired power, based on either an RF conducted or a radiated measurement, provided the transmitter demonstrates compliance with the peak conducted power limits. If the transmitter complies with the conducted power limits based on the use of RMS averaging over a time interval, as permitted under paragraph (b)(3) of this section, the attenuation required under this paragraph shall be 30 dB instead of 20 dB. Attenuation below the general limits specified in Section 15.209(a) is not required. In addition, radiated emissions which fall in the restricted bands, as defined in Section 15.205(a), must also comply with the radiated emission limits specified in Section 15.209(a).

10.3.Restricted bands of operation

10.3.1.FCC Part 15.205 Restricted bands of operation

(a) Except as shown in paragraph (d) of this section, Only spurious emissions are permitted in any of the frequency bands listed below:

MHz	MHz	MHz	GHz
0.090-0.110	16.42-16.423	399.9-410	4.5-5.15
¹ 0.495-0.505	16.69475-16.69525	608-614	5.35-5.46
2.1735-2.1905	16.80425-16.80475	960-1240	7.25-7.75
4.125-4.128	25.5-25.67	1300-1427	8.025-8.5
4.17725-4.17775	37.5-38.25	1435-1626.5	9.0-9.2
4.20725-4.20775	73-74.6	1645.5-1646.5	9.3-9.5
6.215-6.218	74.8-75.2	1660-1710	10.6-12.7
6.26775-6.26825	108-121.94	1718.8-1722.2	13.25-13.4
6.31175-6.31225	123-138	2200-2300	14.47-14.5
8.291-8.294	149.9-150.05	2310-2390	15.35-16.2
8.362-8.366	156.52475-156.52525	2483.5-2500	17.7-21.4
8.37625-8.38675	156.7-156.9	2690-2900	22.01-23.12
8.41425-8.41475	162.0125-167.17	3260-3267	23.6-24.0
12.29-12.293	167.72-173.2	3332-3339	31.2-31.8
12.51975-12.52025	240-285	3345.8-3358	36.43-36.5
12.57675-12.57725	322-335.4	3600-4400	(²)
13.36-13.41			

¹Until February 1, 1999, this restricted band shall be 0.490-0.510

²Above 38.6

(b) Except as provided in paragraphs (d) and (e), the field strength of emission appearing within these frequency bands shall not exceed the limits shown in Section 15.209. At frequencies equal to or less than 1000MHz, Compliance with the limits in Section 15.209 shall be demonstrated using measurement instrumentation employing a CISPR quasi-peak detector. Above 1000MHz, compliance with the emission limits in Section 15.209 shall be demonstrated based on the average value of the measured emissions. The provisions in Section 15.35 apply to these measurements.

10.4.Configuration of EUT on Measurement

The equipment are installed on Radiated Emission Measurement to meet the commission requirements and operating regulations in a manner which tends to maximize its emission characteristics in normal application.

10.5. Operating Condition of EUT

10.5.1. Setup the EUT and simulator as shown as Section 10.1.

10.5.2. Turn on the power of all equipment.

10.5.3. Let the EUT work in TX modes measure it. The transmit frequency are 903.375-926.475MHz. We select 903.375MHz, 914.375MHz, 926.475MHz TX frequency to transmit.

10.6. Test Procedure

The EUT and its simulators are placed on a turntable, which is 0.8 meter high above ground (Below 1GHz). The EUT and its simulators are placed on a turntable, which is 1.5 meter high above ground (Above 1GHz). The turntable can rotate 360 degrees to determine the position of the maximum emission level. EUT is set 3.0 meters away from the receiving antenna, which is mounted on an antenna tower. The antenna can be moved up and down between 1.0 meter and 4 meters to find out the maximum emission level. Broadband antenna (calibrated bi-log antenna) is used as receiving antenna. Both horizontal and vertical polarizations of the antenna are set on measurement. In order to find the maximum emission levels, all of the EUT location must be manipulated according to ANSI C63.10:2013 on radiated emission measurement.

The frequency range from 9KHz to 26500MHz is checked.

During the radiated emission test, the spectrum analyzer was set with the following configurations:

1. The resolution bandwidth and video bandwidth of test receiver/spectrum analyzer is 120kHz for Quasi-peak at frequency below 1GHz.
2. The resolution bandwidth of test receiver/spectrum analyzer is 1MHz and video bandwidth is 3MHz for peak measurement with peak detector at frequency above 1GHz.
3. The resolution bandwidth of test receiver/spectrum analyzer is 1MHz and video bandwidth is 10Hz for Average measurement with peak detection at frequency above 1GHz.
4. All modes of operation were investigated and the worst-case emissions are reported.

10.7.Data Sample

Frequency (MHz)	Reading (dB μ v)	Factor (dB/m)	Result (dB μ v/m)	Limit (dB μ v/m)	Margin (dB)	Remark
X.XX	48.69	-13.35	35.34	46	-10.66	QP

Frequency(MHz) = Emission frequency in MHz
 Reading(dB μ v) = Uncorrected Analyzer/Receiver reading
 Factor (dB/m) = Antenna factor + Cable Loss – Amplifier gain
 Result(dB μ v/m) = Reading(dB μ v) + Factor(dB/m)
 Limit (dB μ v/m) = Limit stated in standard
 Margin (dB) = Result(dB μ v/m) - Limit (dB μ v/m)
 QP = Quasi-peak Reading

Calculation Formula:
 Margin(dB) = Result (dB μ V/m)–Limit(dB μ V/m)
 Result(dB μ V/m)= Reading(dB μ V)+ Factor(dB/m)

The “Margin” column of the following data tables indicates the degree of compliance with the applicable limit. For example, a margin of -7dB means the emission is 7dB below the limit.

10.8.The Field Strength of Radiation Emission Measurement Results

Pass.
 Test Lab: 3m Anechoic chamber
 Test Engineer: Star

- Note:
1. Emissions attenuated more than 20 dB below the permissible value are not reported.
 2. *: Denotes restricted band of operation.
 3. The radiation emissions from 9KHz-30MHz and 18-26.5GHz are not reported, because the test values lower than the limits of 20dB.

The spectrum analyzer plots are attached as below.

Below 1G



ACCURATE TECHNOLOGY CO., LTD.

F1,Bldg,A,Changyuan New Material Port Keyuan Rd,
Science & Industry Park,Nanshan Shenzhen,P.R.China

Site: 2# Chamber
Tel:+86-0755-26503290
Fax:+86-0755-26503396

Job No.: STAR2016 #2700	Polarization: Horizontal
Standard: FCC PART 15C 3M Radiated	Power Source: AC 120V/60Hz
Test item: Radiation Test	Date: 18/08/13/
Temp.(C)/Hum.(%) 23 C / 48 %	Time: 10/02/55
EUT: ESL accesspoint	Engineer Signature: star
Mode: TX 903.375MHz	Distance: 3m
Model: SMARTAP 320	
Manufacturer: SES-inagotag Deutschland GmbH	

Note: Report No.: ATE20181306



No.	Freq. (MHz)	Reading (dBuV/m)	Factor (dB)	Result (dBuV/m)	Limit (dBuV/m)	Margin (dB)	Detector	Height (cm)	Degree (deg.)	Remark
1	135.5062	45.10	-14.08	31.02	43.50	-12.48	QP	200	360	
2	213.7633	35.36	-11.76	23.60	43.50	-19.90	QP	200	277	
3	364.2595	33.12	-7.23	25.89	46.00	-20.11	QP	200	81	
4	416.1791	34.86	-5.95	28.91	46.00	-17.09	QP	200	47	
5	801.7862	39.11	0.87	39.98	46.00	-6.02	QP	200	111	
6	903.3750	79.41	2.20	81.61			peak	200	107	



ACCURATE TECHNOLOGY CO., LTD.

F1,Bldg,A,Changyuan New Material Port Keyuan Rd,
Science & Industry Park,Nanshan Shenzhen,P.R.China

Site: 2# Chamber
Tel:+86-0755-26503290
Fax:+86-0755-26503396

Job No.: STAR2016 #2701	Polarization: Vertical
Standard: FCC PART 15C 3M Radiated	Power Source: AC 120V/60Hz
Test item: Radiation Test	Date: 18/08/13/
Temp.(C)/Hum.(%) 23 C / 48 %	Time: 10/04/08
EUT: ESL accesspoint	Engineer Signature: star
Mode: TX 903.375MHz	Distance: 3m
Model: SMARTAP 320	
Manufacturer: SES-inagotag Deutschland GmbH	

Note: Report No.: ATE20181306



No.	Freq. (MHz)	Reading (dBuV/m)	Factor (dB)	Result (dBuV/m)	Limit (dBuV/m)	Margin (dB)	Detector	Height (cm)	Degree (deg.)	Remark
1	37.5478	41.20	-10.98	30.22	40.00	-9.78	QP	100	159	
2	57.7961	38.62	-13.49	25.13	40.00	-14.87	QP	100	244	
3	149.4857	50.67	-15.05	35.62	43.50	-7.88	QP	100	236	
4	801.7862	37.29	0.87	38.16	46.00	-7.84	QP	100	147	
5	903.3750	90.01	2.22	92.23			peak	100	150	
6	929.0081	38.81	2.75	41.56	46.00	-4.44	QP	100	119	



ACCURATE TECHNOLOGY CO., LTD.

F1,Bldg,A,Changyuan New Material Port Keyuan Rd,
Science & Industry Park,Nanshan Shenzhen,P.R.China

Site: 2# Chamber
Tel:+86-0755-26503290
Fax:+86-0755-26503396

Job No.: STAR2016 #2696	Polarization: Horizontal
Standard: FCC PART 15C 3M Radiated	Power Source: AC 120V/60Hz
Test item: Radiation Test	Date: 18/08/13/
Temp.(C)/Hum.(%) 23 C / 48 %	Time: 9/53/30
EUT: ESL accesspoint	Engineer Signature: star
Mode: TX 914.375MHz	Distance: 3m
Model: SMARTAP 320	
Manufacturer: SES-inagotag Deutschland GmbH	

Note: Report No.: ATE20181306



No.	Freq. (MHz)	Reading (dBuV/m)	Factor (dB)	Result (dBuV/m)	Limit (dBuV/m)	Margin (dB)	Detector	Height (cm)	Degree (deg.)	Remark
1	135.0319	47.14	-13.97	33.17	43.50	-10.33	QP	200	150	
2	287.9904	37.10	-9.34	27.76	46.00	-18.24	QP	200	171	
3	351.7078	35.10	-7.40	27.70	46.00	-18.30	QP	200	240	
4	672.8444	32.75	-1.44	31.31	46.00	-14.69	QP	200	254	
5	801.7862	37.14	0.87	38.01	46.00	-7.99	QP	200	110	
6	914.3750	77.59	2.40	79.99			peak	200	132	



ACCURATE TECHNOLOGY CO., LTD.

F1,Bldg,A,Changyuan New Material Port Keyuan Rd,
Science & Industry Park,Nanshan Shenzhen,P.R.China

Site: 2# Chamber
Tel:+86-0755-26503290
Fax:+86-0755-26503396

Job No.: STAR2016 #2697	Polarization: Vertical
Standard: FCC PART 15C 3M Radiated	Power Source: AC 120V/60Hz
Test item: Radiation Test	Date: 18/08/13/
Temp.(C)/Hum.(%) 23 C / 48 %	Time: 9/55/12
EUT: ESL accesspoint	Engineer Signature: star
Mode: TX 914.375MHz	Distance: 3m
Model: SMARTAP 320	
Manufacturer: SES-inagotag Deutschland GmbH	

Note: Report No.: ATE20181306

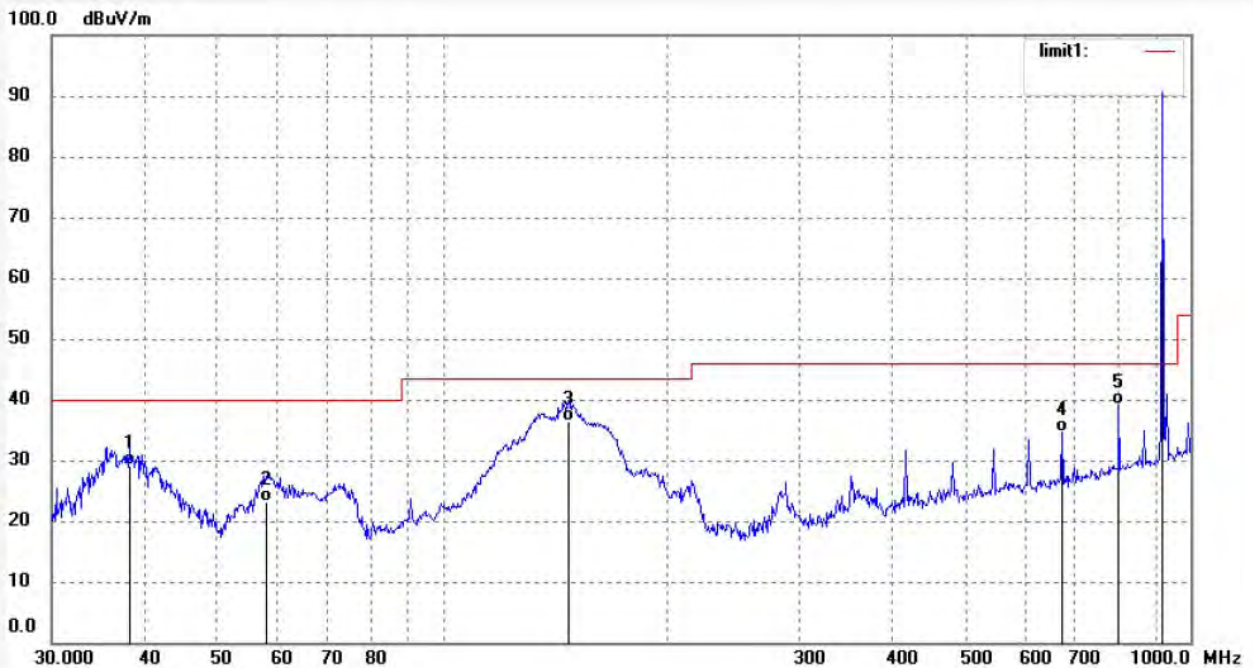

No.	Freq. (MHz)	Reading (dBuV/m)	Factor (dB)	Result (dBuV/m)	Limit (dBuV/m)	Margin (dB)	Detector	Height (cm)	Degree (deg.)	Remark
1	38.0782	40.24	-11.10	29.14	40.00	-10.86	QP	100	141	
2	57.9992	36.70	-13.52	23.18	40.00	-16.82	QP	100	48	
3	147.4036	51.58	-15.08	36.50	43.50	-7.00	QP	100	110	
4	672.8444	36.06	-1.44	34.62	46.00	-11.38	QP	100	217	
5	801.7862	38.16	0.87	39.03	46.00	-6.97	QP	100	304	
6	914.3750	88.11	2.40	90.51			peak	100	244	



ACCURATE TECHNOLOGY CO., LTD.

F1,Bldg,A,Changyuan New Material Port Keyuan Rd,
Science & Industry Park,Nanshan Shenzhen,P.R.China

Site: 2# Chamber
Tel:+86-0755-26503290
Fax:+86-0755-26503396

Job No.: STAR2016 #2699
Standard: FCC PART 15C 3M Radiated
Test item: Radiation Test
Temp.(C)/Hum.(%) 23 C / 48 %
EUT: ESL accesspoint
Mode: TX 926.475MHz
Model: SMARTAP 320
Manufacturer: SES-inagotag Deutschland GmbH

Polarization: Horizontal
Power Source: AC 120V/60Hz
Date: 18/08/13/
Time: 10/00/11
Engineer Signature: star
Distance: 3m

Note: Report No.: ATE20181306



No.	Freq. (MHz)	Reading (dBuV/m)	Factor (dB)	Result (dBuV/m)	Limit (dBuV/m)	Margin (dB)	Detector	Height (cm)	Degree (deg.)	Remark
1	135.0319	46.70	-13.97	32.73	43.50	-10.77	QP	200	100	
2	215.2677	35.24	-11.67	23.57	43.50	-19.93	QP	200	111	
3	351.7078	36.97	-7.40	29.57	46.00	-16.43	QP	200	241	
4	607.7866	35.07	-2.24	32.83	46.00	-13.17	QP	200	278	
5	801.7862	38.31	0.87	39.18	46.00	-6.82	QP	200	300	
6	926.4750	78.79	2.75	81.54			peak	200	294	



ACCURATE TECHNOLOGY CO., LTD.

F1,Bldg,A,Changyuan New Material Port Keyuan Rd,
Science & Industry Park,Nanshan Shenzhen,P.R.China

Site: 2# Chamber
Tel:+86-0755-26503290
Fax:+86-0755-26503396

Job No.: STAR2016 #2698
Standard: FCC PART 15C 3M Radiated
Test item: Radiation Test
Temp.(C)/Hum.(%) 23 C / 48 %
EUT: ESL accesspoint
Mode: TX 926.475MHz
Model: SMARTAP 320
Manufacturer: SES-inagotag Deutschland GmbH

Polarization: Vertical
Power Source: AC 120V/60Hz
Date: 18/08/13/
Time: 9/58/19
Engineer Signature: star
Distance: 3m

Note: Report No.: ATE20181306

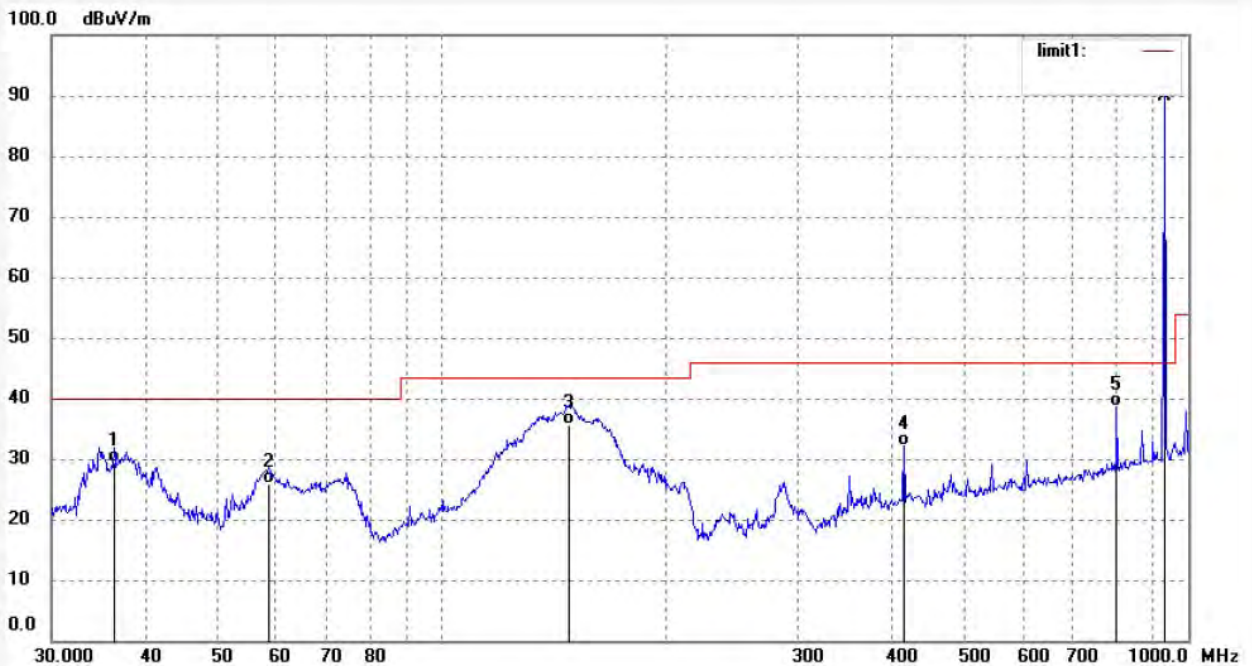

No.	Freq. (MHz)	Reading (dBuV/m)	Factor (dB)	Result (dBuV/m)	Limit (dBuV/m)	Margin (dB)	Detector	Height (cm)	Degree (deg.)	Remark
1	36.3813	40.10	-10.72	29.38	40.00	-10.62	QP	100	224	
2	58.6126	39.57	-13.64	25.93	40.00	-14.07	QP	100	179	
3	147.9214	50.70	-15.07	35.63	43.50	-7.87	QP	100	255	
4	416.1791	38.04	-5.95	32.09	46.00	-13.91	QP	100	307	
5	801.7862	37.80	0.87	38.67	46.00	-7.33	QP	100	99	
6	926.4750	87.17	2.75	89.92			peak	100	172	

Above 1G



ACCURATE TECHNOLOGY CO., LTD.

F1,Bldg.A,Changyuan New Material Port Keyuan Rd,
Science & Industry Park,Nanshan Shenzhen,P.R.China

Site: 2# Chamber
Tel:+86-0755-26503290
Fax:+86-0755-26503396

Job No.: star2016 #2664	Polarization: Horizontal
Standard: FCC PART 15C 3M Radiated	Power Source: AC 120V/60Hz
Test item: Radiation Test	Date: 18/08/14/
Temp.(C)/Hum.(%) 23 C / 48 %	Time: 9/58/11
EUT: ESL accesspoint	Engineer Signature: star
Mode: TX 903.375MHz	Distance: 3m
Model: SMARTAP 320	
Manufacturer: SES-inagotag Deutschland GmbH	

Note: Report No.: ATE20181306

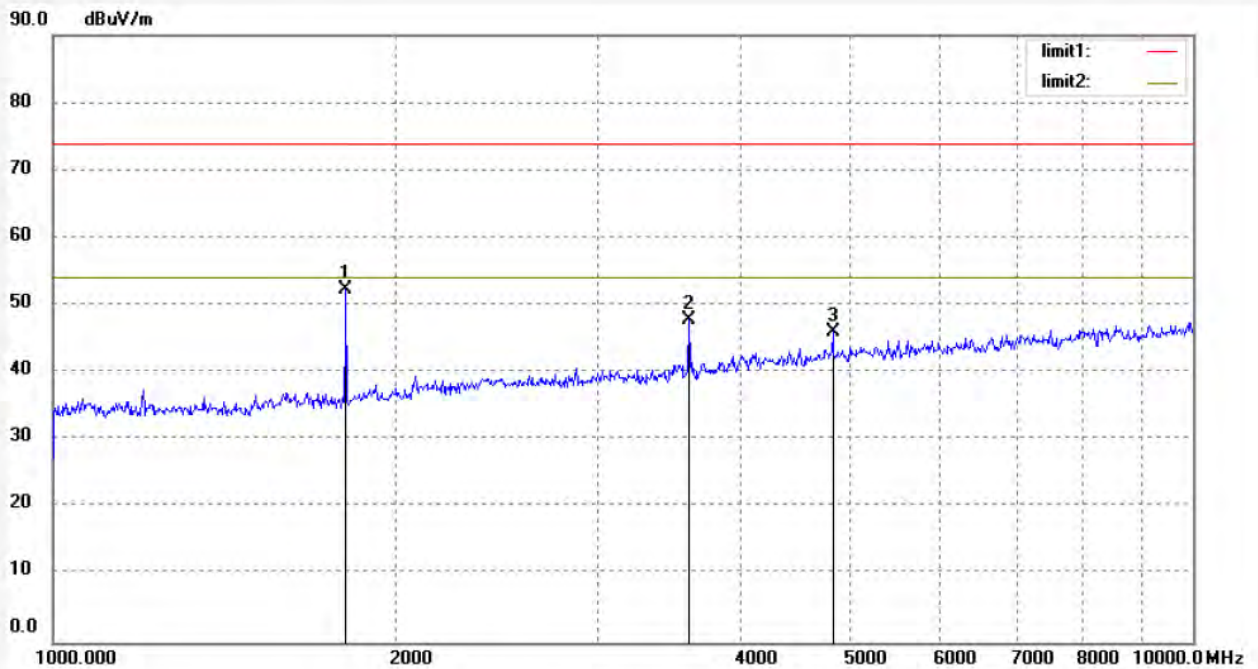

No.	Freq. (MHz)	Reading (dBuV/m)	Factor (dB)	Result (dBuV/m)	Limit (dBuV/m)	Margin (dB)	Detector	Height (cm)	Degree (deg.)	Remark
1	1806.754	55.09	-2.87	52.22	74.00	-21.78	peak	200	204	
2	3613.509	44.43	3.41	47.84	74.00	-26.16	peak	200	314	
3	4830.588	38.34	7.64	45.98	74.00	-28.02	peak	200	38	



ACCURATE TECHNOLOGY CO., LTD.

F1,Bldg,A,Changyuan New Material Port Keyuan Rd,
Science & Industry Park,Nanshan Shenzhen,P.R.China

Site: 2# Chamber
Tel:+86-0755-26503290
Fax:+86-0755-26503396

Job No.: star2016 #2663	Polarization: Vertical
Standard: FCC PART 15C 3M Radiated	Power Source: AC 120V/60Hz
Test item: Radiation Test	Date: 18/08/14/
Temp.(C)/Hum.(%) 23 C / 48 %	Time: 9/56/01
EUT: ESL accesspoint	Engineer Signature: star
Mode: TX 903.375MHz	Distance: 3m
Model: SMARTAP 320	
Manufacturer: SES-inagotag Deutschland GmbH	

Note: Report No.: ATE20181306

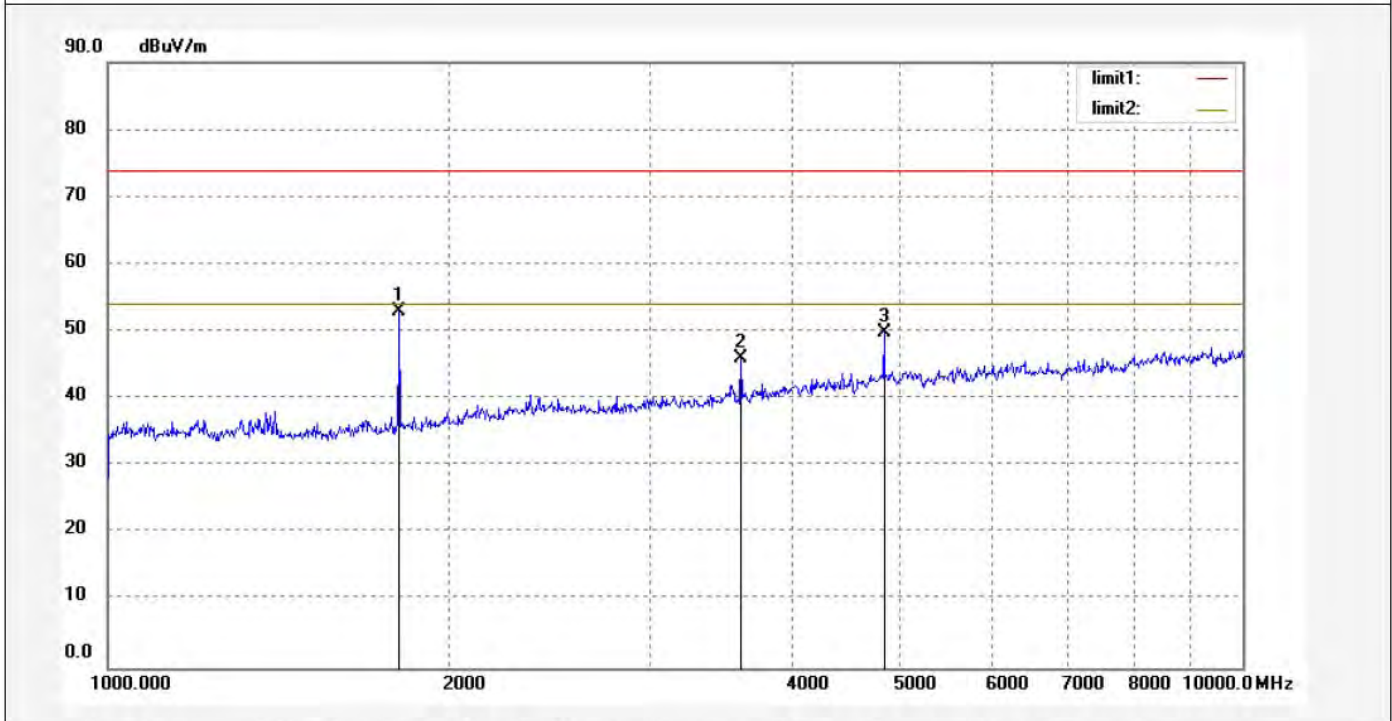

No.	Freq. (MHz)	Reading (dBuV/m)	Factor (dB)	Result (dBuV/m)	Limit (dBuV/m)	Margin (dB)	Detector	Height (cm)	Degree (deg.)	Remark
1	1806.754	55.87	-2.87	53.00	74.00	-21.00	peak	150	117	
2	3613.509	42.71	3.41	46.12	74.00	-27.88	peak	150	109	
3	4830.588	42.15	7.64	49.79	74.00	-24.21	peak	150	159	



ACCURATE TECHNOLOGY CO., LTD.

F1,Bldg,A,Changyuan New Material Port Keyuan Rd,
Science & Industry Park,Nanshan Shenzhen,P.R.China

Site: 2# Chamber
Tel:+86-0755-26503290
Fax:+86-0755-26503396

Job No.: star2016 #2666
Standard: FCC PART 15C 3M Radiated
Test item: Radiation Test
Temp.(C)/Hum.(%) 23 C / 48 %
EUT: ESL accesspoint
Mode: TX 914.375MHz
Model: SMARTAP 320
Manufacturer: SES-inagotag Deutschland GmbH

Polarization: Horizontal
Power Source: AC 120V/60Hz
Date: 18/08/14/
Time: 10/03/01
Engineer Signature: star
Distance: 3m

Note: Report No.: ATE20181306

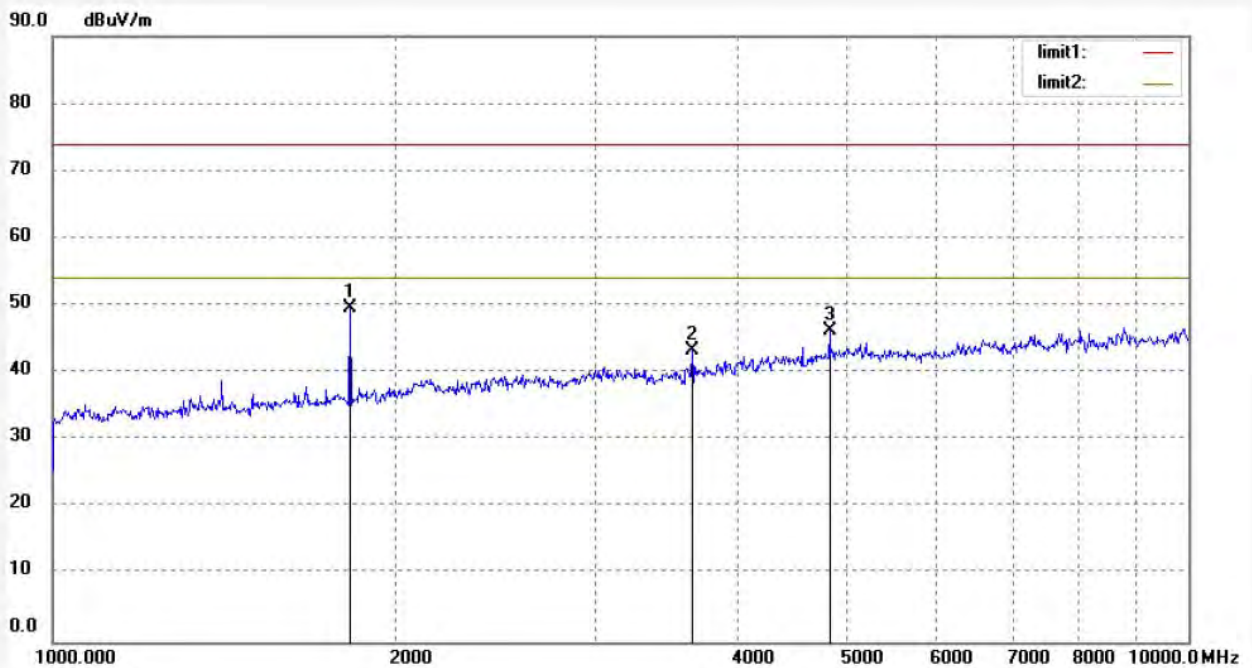

No.	Freq. (MHz)	Reading (dBuV/m)	Factor (dB)	Result (dBuV/m)	Limit (dBuV/m)	Margin (dB)	Detector	Height (cm)	Degree (deg.)	Remark
1	1828.750	52.21	-2.59	49.62	74.00	-24.38	peak	200	121	
2	3657.548	39.78	3.56	43.34	74.00	-30.66	peak	200	51	
3	4830.588	38.60	7.64	46.24	74.00	-27.76	peak	200	311	



ACCURATE TECHNOLOGY CO., LTD.

F1,Bldg,A,Changyuan New Material Port Keyuan Rd,
Science & Industry Park,Nanshan Shenzhen,P.R.China

Site: 2# Chamber
Tel:+86-0755-26503290
Fax:+86-0755-26503396

Job No.: star2016 #2667	Polarization: Vertical
Standard: FCC PART 15C 3M Radiated	Power Source: AC 120V/60Hz
Test item: Radiation Test	Date: 18/08/14/
Temp.(C)/Hum.(%) 23 C / 48 %	Time: 10/04/37
EUT: ESL accesspoint	Engineer Signature: star
Mode: TX 914.375MHz	Distance: 3m
Model: SMARTAP 320	
Manufacturer: SES-inagotag Deutschland GmbH	

Note: Report No.: ATE20181306

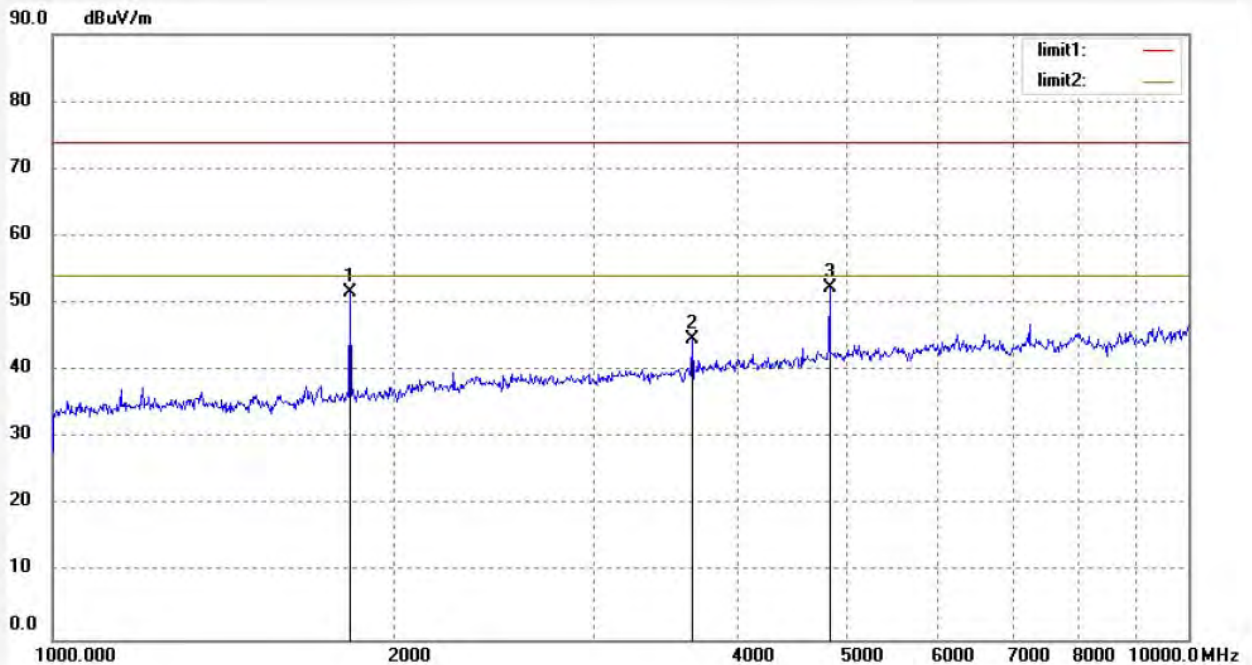

No.	Freq. (MHz)	Reading (dBuV/m)	Factor (dB)	Result (dBuV/m)	Limit (dBuV/m)	Margin (dB)	Detector	Height (cm)	Degree (deg.)	Remark
1	1828.750	54.27	-2.59	51.68	74.00	-22.32	peak	100	147	
2	3657.548	41.13	3.56	44.69	74.00	-29.31	peak	100	231	
3	4830.588	44.76	7.64	52.40	74.00	-21.60	peak	100	297	



ACCURATE TECHNOLOGY CO., LTD.

F1,Bldg,A,Changyuan New Material Port Keyuan Rd,
Science & Industry Park,Nanshan Shenzhen,P.R.China

Site: 2# Chamber
Tel:+86-0755-26503290
Fax:+86-0755-26503396

Job No.: star2016 #2669
Standard: FCC PART 15C 3M Radiated
Test item: Radiation Test
Temp.(C)/Hum.(%) 23 C / 48 %
EUT: ESL accesspoint
Mode: TX 926.475MHz
Model: SMARTAP 320
Manufacturer: SES-inagotag Deutschland GmbH

Polarization: Horizontal
Power Source: AC 120V/60Hz
Date: 18/08/14/
Time: 10/11/07
Engineer Signature: star
Distance: 3m

Note: Report No.: ATE20181306

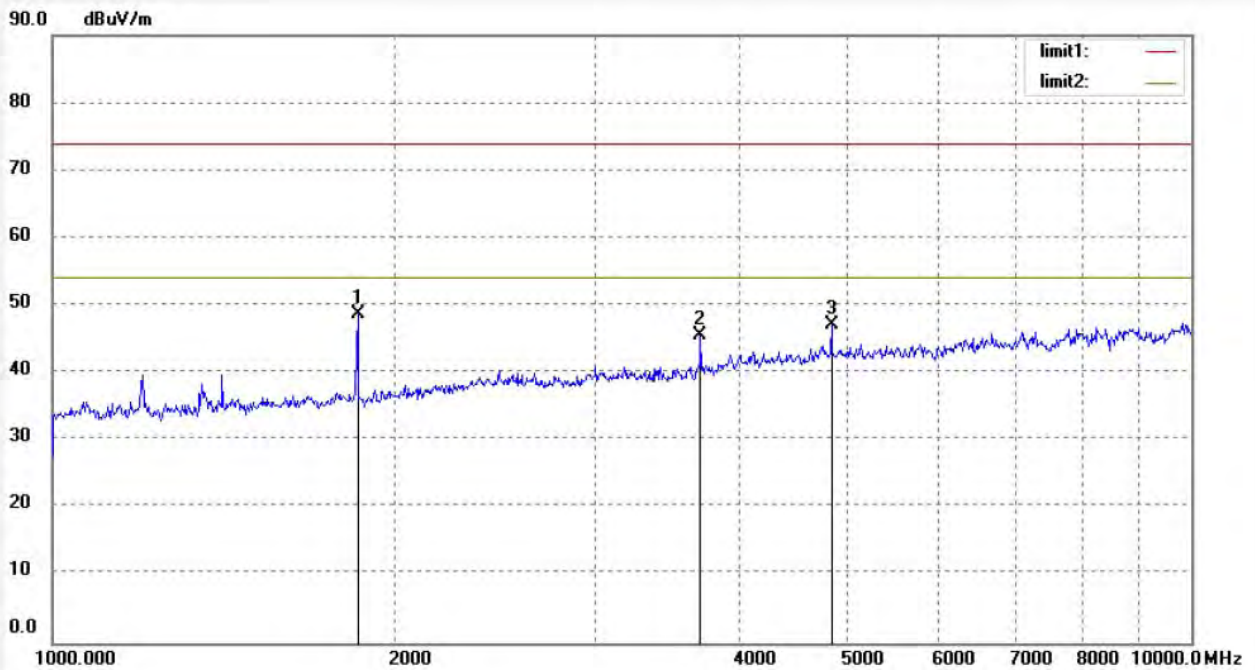

No.	Freq. (MHz)	Reading (dBuV/m)	Factor (dB)	Result (dBuV/m)	Limit (dBuV/m)	Margin (dB)	Detector	Height (cm)	Degree (deg.)	Remark
1	1852.952	51.08	-2.30	48.78	74.00	-25.22	peak	200	107	
2	3705.907	41.90	3.73	45.63	74.00	-28.37	peak	200	247	
3	4830.588	39.39	7.64	47.03	74.00	-26.97	peak	200	324	



ACCURATE TECHNOLOGY CO., LTD.

F1,Bldg,A,Changyuan New Material Port Keyuan Rd,
Science & Industry Park,Nanshan Shenzhen,P.R.China

Site: 2# Chamber
Tel:+86-0755-26503290
Fax:+86-0755-26503396

Job No.: star2016 #2668	Polarization: Vertical
Standard: FCC PART 15C 3M Radiated	Power Source: AC 120V/60Hz
Test item: Radiation Test	Date: 18/08/14/
Temp.(C)/Hum.(%) 23 C / 48 %	Time: 10/09/25
EUT: ESL accesspoint	Engineer Signature: star
Mode: TX 926.475MHz	Distance: 3m
Model: SMARTAP 320	
Manufacturer: SES-inagotag Deutschland GmbH	

Note: Report No.: ATE20181306

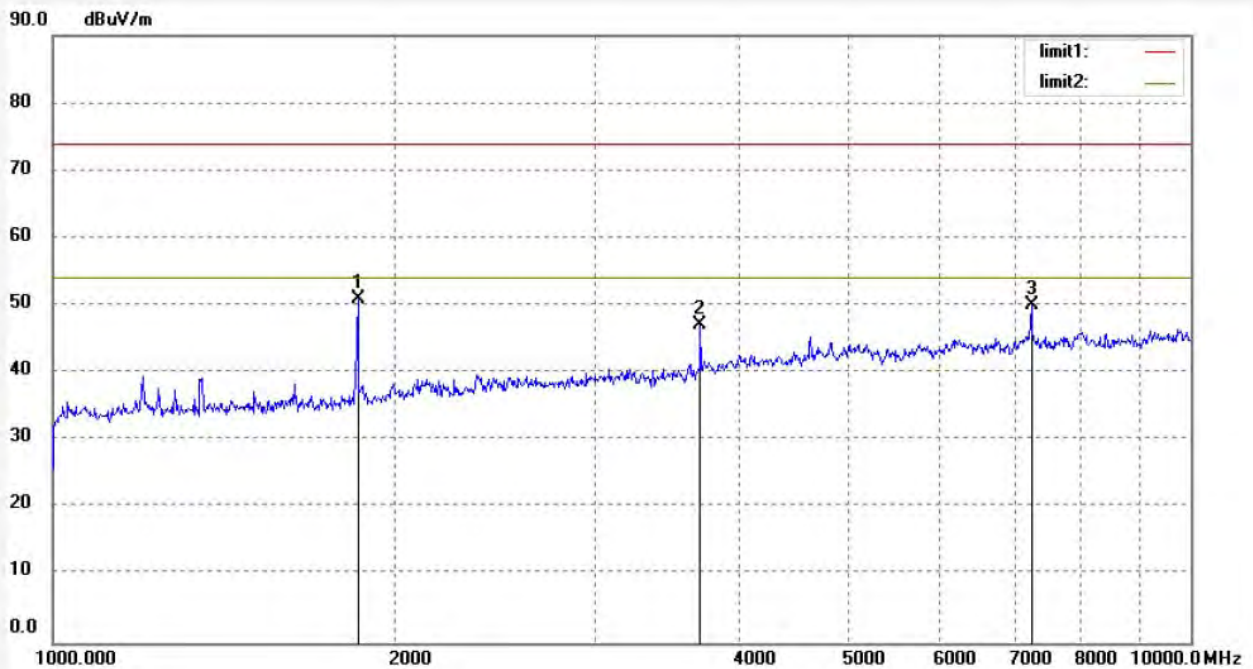

No.	Freq. (MHz)	Reading (dBuV/m)	Factor (dB)	Result (dBuV/m)	Limit (dBuV/m)	Margin (dB)	Detector	Height (cm)	Degree (deg.)	Remark
1	1852.952	53.20	-2.30	50.90	74.00	-23.10	peak	100	47	
2	3705.907	43.32	3.73	47.05	74.00	-26.95	peak	100	127	
3	7244.359	38.90	11.06	49.96	74.00	-24.04	peak	100	322	

11. ANTENNA REQUIREMENT

11.1. The Requirement

According to Section 15.203, an intentional radiator shall be designed to ensure that no antenna other than that furnished by the responsible party shall be used with the device.

11.2. Antenna Construction

The antenna use a unique coupling to the intentional radiator shall be considered sufficient to comply with the provisions of this section. The manufacturer may design the unit so that a broken antenna can be replaced by the user, but the use of a standard antenna jack or electrical connector is prohibited. The antenna jack of EUT correspond to the standard. The Antenna gain of EUT is -2.3dBi. Therefore, the equipment complies with the antenna requirement of Section 15.203.

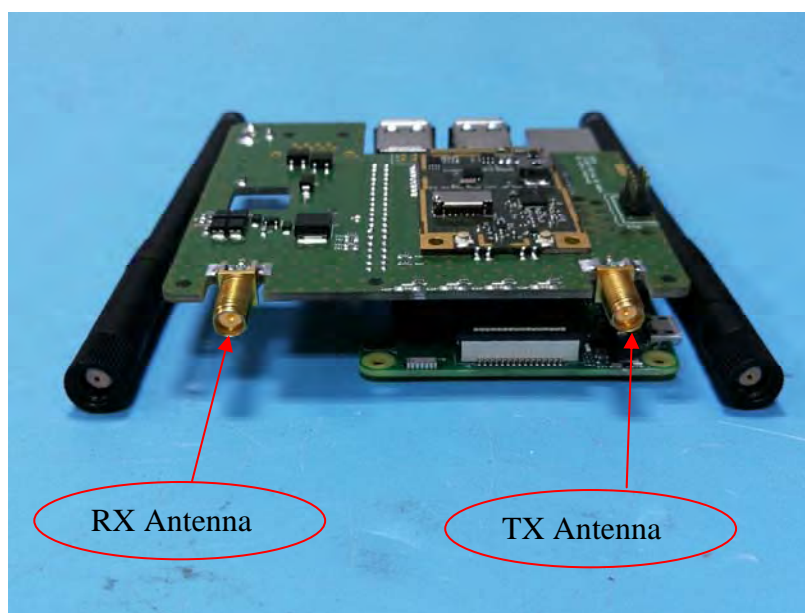

----- THE END OF TEST REPORT -----