

Antenna Specification

Specifications

Summary

ITEM	SPEC.
Model Name	IBM 2.4 GHz
Center Frequency	2402 MHz -2.10 dBi
	2441 MHz -1.78 dBi
	2480 MHz -1.52 dBi
MAX. GAIN	-1.52dBi
Polarization	Horizontal
Azimuth Beam Pattern	Omni-directional
Impedance	50 Ω
Antenna Length	31.5cm

Antenna Photo & Length

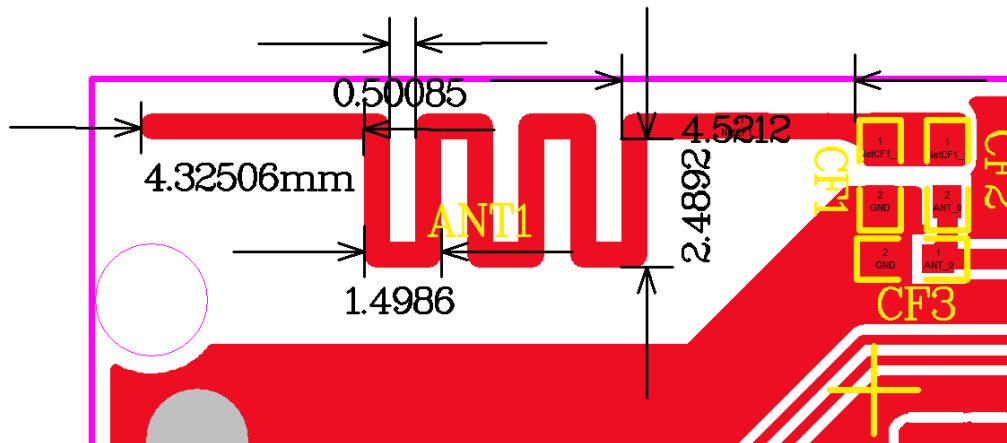

1. Main antenna : 2402 MHz

1.1 Horizontal

◆ XY-plane

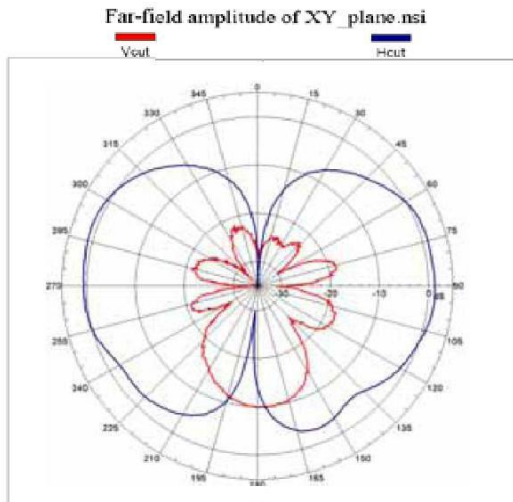

Unit : dBi

	Peak gain	Avg. gain
H cut	-2.93	-7.60
V cut	-6.85	-8.27
Total	-2.10	-5.33

1.2 Vertical

◆ XZ-plane

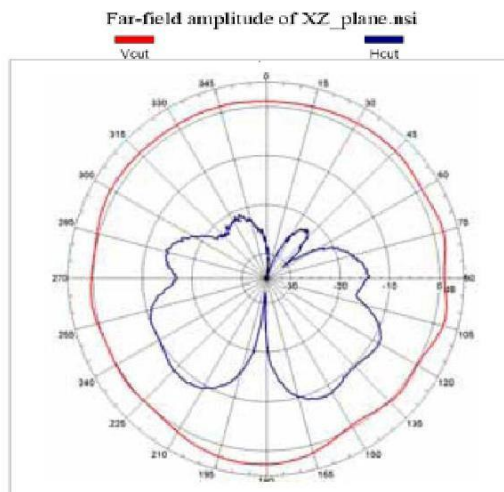

	Peak gain	Avg. gain
H cut	-5.83	-13.44
V cut	-7.04	-9.47
Total	-5.02	-7.25

2. Main antenna : 2441 MHz

2.1 Horizontal

◆ XY-plane

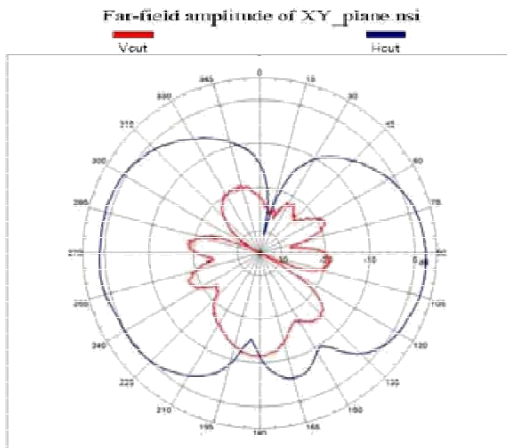

Unit : dBi

	Peak gain	Avg. gain
H cut	-2.36	-7.43
V cut	-11.01	-13.04
Total	-1.78	-8.05

2.2 Vertical

◆ XZ-plane

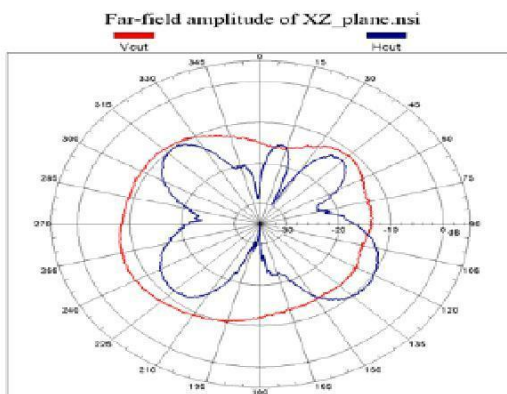

	Peak gain	Avg. gain
H cut	-7.85	-14.39
V cut	-7.02	-12.30
Total	-5.80	-8.78

3. Main antenna : 2480 MHz

3.1 Horizontal

◆ YZ-plane

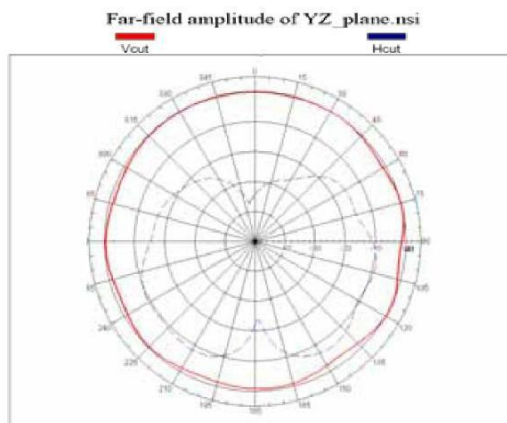

	Peak gain	Avg. gain
H cut	-4.74	-10.75
V cut	-6.47	-11.05
Total	-1.52	-7.49

3.2 Vertical

◆YZ-plane

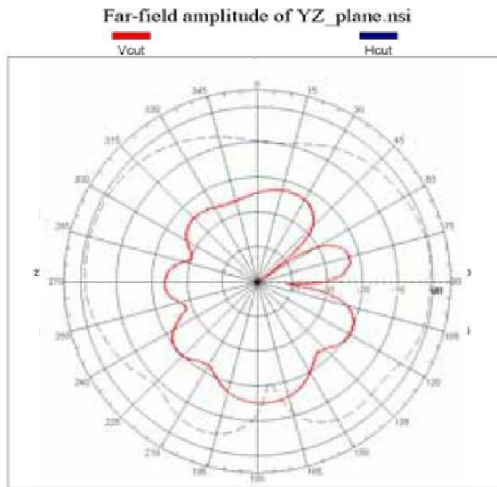

	Peak gain	Avg. gain
H cut	-5.75	-9.75
V cut	-12.47	-16.23
Total	-4.52	-8.72

4. Result

Center Frequency	Maximum Ant Gain	
2402MHz	H	-2.10 dBi
	V	-5.02 dBi
2441 MHz	H	-1.78 dBi
	V	-5.80 dBi
2480 MHz	H	-1.52 dBi
	V	-4.52 dBi

Manufacturer: GUANGZHOU JEDELIT ELECTRONIC TECHNOLOGY CO.,LTD.
 Manufacturer address: Room 101, Building A, No.5 Minying Avenue west, Xintang town, Zengcheng District, Guangzhou, China