



**User Manual**

## Dear user

### Thank you for purchasing a smart lock

Using innovative technology to improve the quality of life, create the world's best and most innovative products, and make enterprises industry standards. They always adhere to the business philosophy of "survival with quality, development with service" in the intelligent lock industry, constantly improving the product quantity system. Our company keeps up with the pace of the times, always walks at the forefront of the industry, and always unwaveringly guarantees the safety of people's property  
From products to services, we always strive to provide you with comprehensive, thoughtful and comfortable services!  
Thank you for your support of the smart lock

### Disclaimer:

We have made every effort to ensure that the information provided in this manual is correct and reliable, but we cannot fully guarantee any errors that may occur before or during the printing process.

Sometimes, in order to improve the performance, reliability, and safety of components and systems, we may upgrade the product, which may be inconsistent with the instructions, but does not affect actual operation. We reserve the right to make changes without prior notice. Please understand! Our company will regularly update the content. If you have any questions, please call our company for consultation. The final interpretation rights of all contents of this manual belong to our company. The functions described in this statement are not used as a reason for using this product for special purposes, and our company does not assume any responsibility for any accidents or hazards caused by customer misoperation.

## Description of the directory

<b>Safety and precautions</b> .....	01
<b>Installation diagram of double tongue lock body</b> .....	02
<b>Intelligent Lock appearance size diagram</b> .....	03
<b>Hand-to-hand reversing method</b> .....	04
<b>Schematic diagram of lock body and lock installation</b> .....	05
<b>Open Door Direction Indicator</b> .....	06
<b>Brief Introduction and Download of APP</b> .....	07
<b>Technical Parameter of Product</b> .....	17
<b>Local shortcut</b> .....	18

## Safety and precautions

- As a high-tech product, the installation of smart door locks directly affects the normal operation and service life of the locks. It is recommended that you install the door locks after the room has been decorated. Please choose professional installation personnel to install them, and the installation personnel must strictly follow our company's installation standards.
- Do not use in environments with strong radiation, high magnetic fields, and high temperatures that contain corrosive substances to avoid affecting the performance and lifespan of smart locks.
- Please initialize the door lock as soon as it is installed, restore the lock to its initialized state, and immediately set the settings of your electronic key after initialization to prevent others from illegally opening your door lock.
- Please replace the same brand of No. 7 and No. 4 1.5V high alkaline batteries at the same time. Mixing new and old batteries or using non breaking batteries will damage your door lock.
- Read this manual carefully before use. If you have any questions, you can directly contact our customer service centers or headquarters service centers in various regions. Our company has professional technical personnel to serve you and ensure that you can use it with confidence.
- In response to the national regulations on the management of prohibited items, this product does not come with a battery when leaving the factory

## Fingerprint Lock User Manual

Product performance:

Home office locks suitable for indoor lock and door in 35-50 mm

### 1. Decide door-opening direction

People standing out of the door and facing it:

When the hinge is at left, the door is left opening door. When the hinge is at right, the door is right opening door. Adjust the direction of the handle and tongue according to the opening direction of the door when installing it

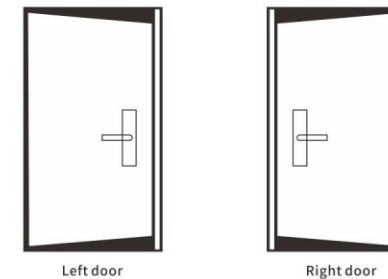

### 2. .change the direction of the lock body (reverse direction)

When installing the lock body, the latch bolt is above and the inclined plane of the lower latch bolt faces the door closing direction; otherwise, the direction of the latch bolt should be adjusted as follows:

- (1) Insert the lock body downwards with the latch bolt.(Picture II)
- (2) Press the latch bolt firmly below the side plate, and rotate the stopper downward and 180(Figure 2).
- (3) Push the latch bolt into the latch bolt hole.(Picture III)

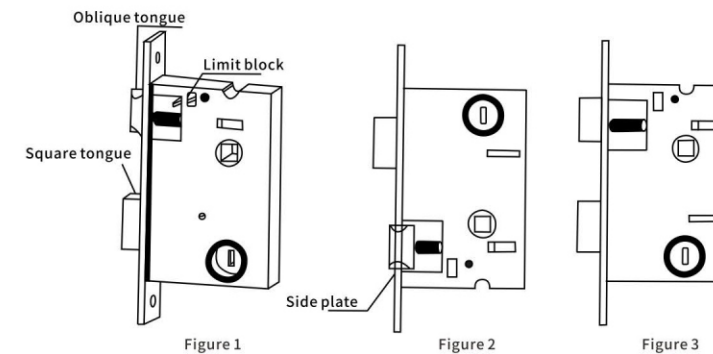

## Appearance Dimension Diagram of Smart Lock

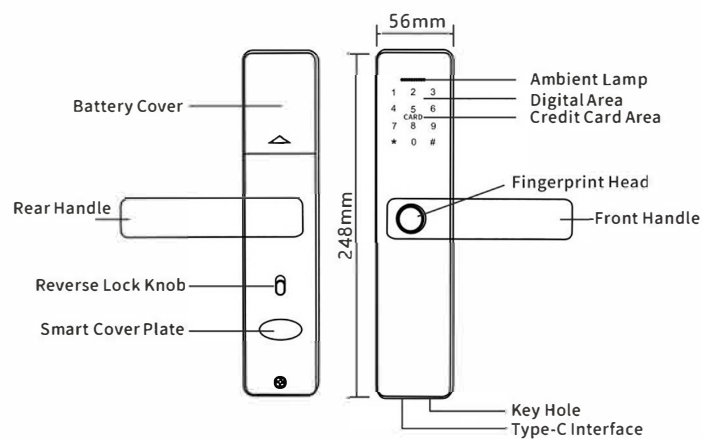

## Configuration List

No.	Schematic Diagram	Configuration Name	Quantity	Remarks
1		Lock Body	1	50 x 50 mm round body (22 x 160 mm)
2		Door Buckle Plate	1	
3		Door Buckle Box	1	
4		Key	2	Save separately, please do not put it in the prints lock room
5		Square Steel	1	8x8x80 mm
6		Crossed Round Head Screws	2	4x20 mm
7		Crossed Round Head Screws	2	4x32mm
8		Installation of screws	2	4x5x35mm

## Drilling according to installation paper regulations

1. Please carefully refer to the installation paper regulations and drill the door hole based on the paper regulations
2. In case there is any deviation in the drilling, sleeve the lock body and panel assembly into the door plate and then correct the hole position until it is suitable

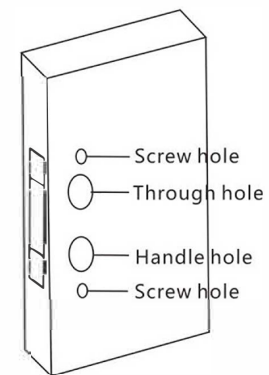

## Handle turnover method

1. Take out the cross screw in the figure and turn the handle 180 degrees in the direction of the arrow.
2. After adjusting the direction of the handle, install the cross screw to the original position and tighten it to complete the reverse.

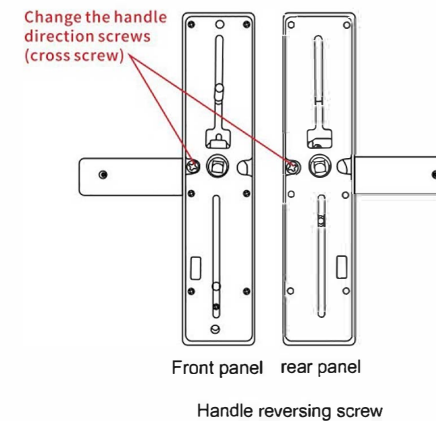

## Lock installation lock body and pinch plate

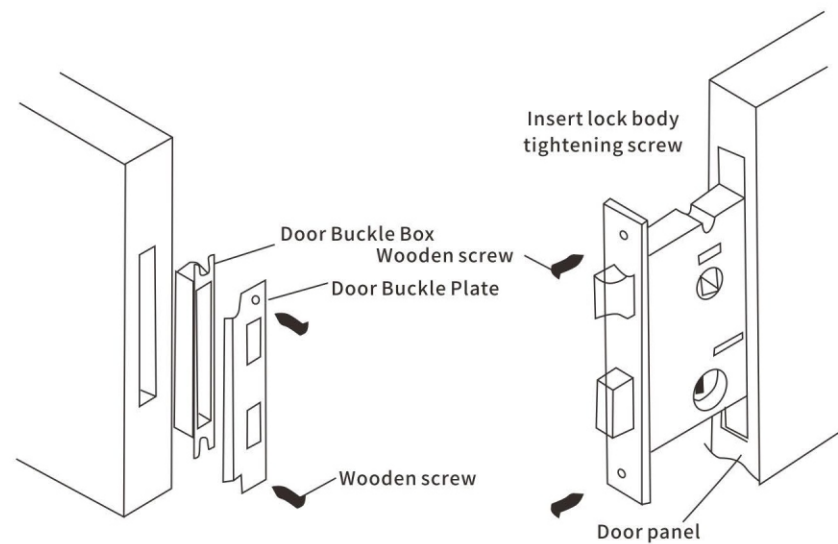

Install the door gusset plate directly opposite to the lock body, and require that the gusset plate hole corresponds to the bolt of the lock body. In case there is any deviation, it must be adjusted.

Install the lock body to the door with two wooden screws, requiring the lock body to be parallel to the door panel after installation.

## Schematic Diagram of Lock Installation Finally, the front panel and the rear panel and butted with the power cord.

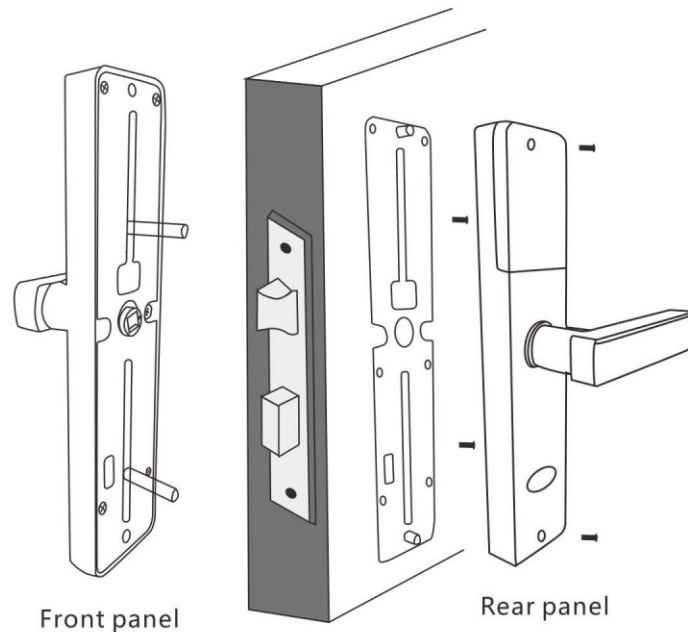

## Door opening direction: open right

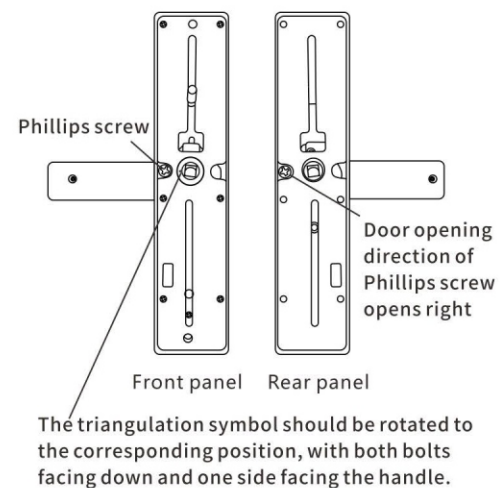

## Door opening direction: Open left

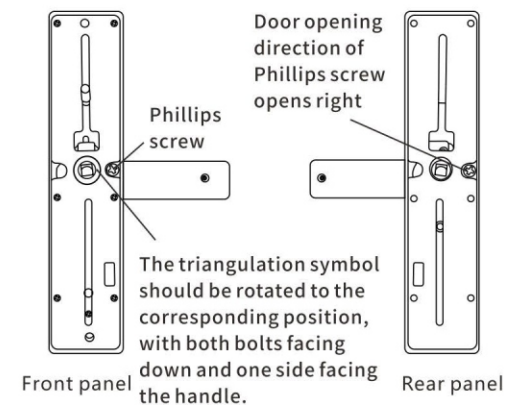

## Brief Introduction and Download of APP

"Tuya Intelligent APP" is the intelligent device management APP provided by Tuya to end consumers, through which you can conveniently configure and control the whole-house intellectual products you purchased, configure your favorite scenes and automation programs, share your smart devices with your family and friends, and enjoy the fun of whole-house smart devices. You can share your smart devices with your family and friends and enjoy the fun of whole-house intelligence.

Download of APP: Search the "Tuya Intelligent" in mobile application market or the "Apple Store", or scan the following QR code to download the APP. This document takes Intelligent Life APP as an example and explains the functions of APP & door lock panel in detail.



## I. Registration and Login of APP

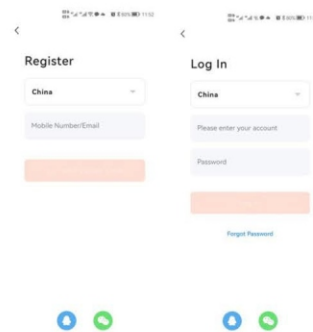

**APP Registration:** If you still fail to register an APP account, you can either register or log in by SMS verification code.  
Click "Create An Account" to enter the account registration page. Follow the instructions to get the SMS verification code and set the password.  
If you already have registered an account, you can click "Login with Existing Account" to log in the APP. You could log in by the ways of password, Verification Code and social account.

## II. Add Bluetooth Lock (Bluetooth of Mobile Phone Must Be Turned On)

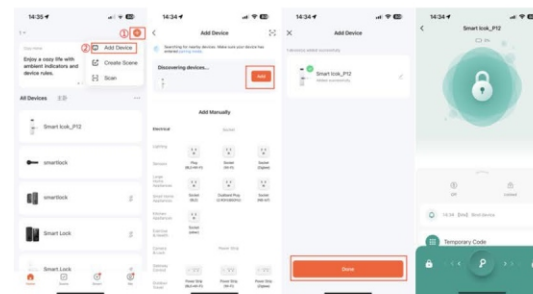

1. Click the "Add Device" icon on the home page of APP.
2. Touch the fingerprint head or screen to wake up the lock, after the mobile phone scanning out the device to be connected, press the button "Add", and then press the "+" icon to add the device.
3. After the device is added, the interface of the intelligent lock interface will display an intelligent lock, indicating that the device has been added successfully.

\*If an administrator has been added to the lock terminal, you need to manually open the Bluetooth configuration of the door lock by entering "9#" on the lock terminal;

### III. Bluetooth Lock Panel—Home Page

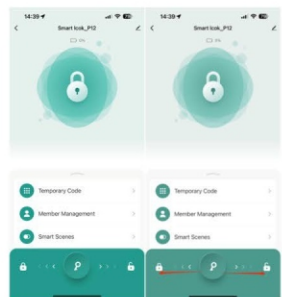

1. The lower part of the home page contains, "Door Open Record and Device Alarm", "Member Management", "Intelligent Application", and "Settings". The top part of the home page displays the name of the door lock and the current battery status.
2. The central part of the home page will display the Bluetooth connection status. If the Bluetooth is connected, you can slide to the right → "unlock", directly open the door lock. Then you can also slide to the left ← "lock". (Please make sure that the Bluetooth of your mobile phone has been turned on, and keep the mobile phone and the door lock to be in a reasonable distance range which is recommended to be within 5 meters); if the Bluetooth is not connected, it will show "can not connect Bluetooth", in which case you can not open the Bluetooth door lock directly through the APP.

### IV. Management of Secret Key (Add or Delete Secret Key)

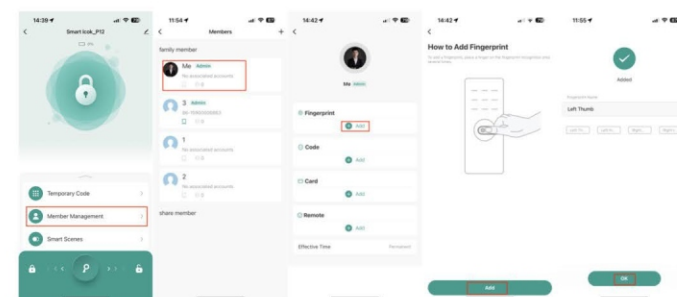

1. Home page "Member Management" portal → Select "Family Member Accounts" with corresponding privileges. Note: The associated administrators will have administrator's privileges, while the associated ordinary members will only have ordinary user's privileges;
2. In case of needing to recording the secret keys, for example, adding fingerprint, click "Start Adding" and then the blue light will be on to enter the fingerprint collecting interface. Press the fingerprint and then release when the green light is on, each fingerprint needs to be collected for 5 times. When the indicator light is off, the fingerprint is collected successfully.
3. In case of connecting the door lock via Bluetooth successfully, the administrator can collect fingerprints for himself/herself or other family members.
4. Click the added secret key in the member to delete such secret key.
5. When unlocking by secret key, green light indicates successful verification, and red light indicates verification failure.

## V. App Function Setting

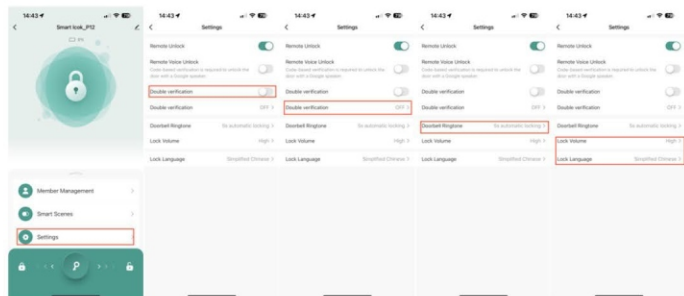

1. Slide the "Setting" menu at the bottom of the main interface, and select to turn on or turn off the "Always-on Mode". When the always-on mode of the door lock is turned off, the door lock will be kept unlocked, which is convenient to enter and exit at any time, and after the user verifies the fingerprint, the always-on mode will be turned off by default. You can also turn off the always-on mode in the APP, or slide the lock to the left to turn off the always-on mode;
2. Slide the "Setting" menu at the bottom of the main interface, and select to turn on or turn off "Double Check". When the double check of the door lock is turned on, only two inconsistent secret keys could be used to open the door;
3. "Auto-Lock Time Setting", customers can choose the auto-lock time according to their needs, and after successful verification, the door lock will be double locked automatically according to the time setting;
4. The voice volume and language menu of the door lock could be set based on the requirements.

## VI. Member Management - Addition of Administrator

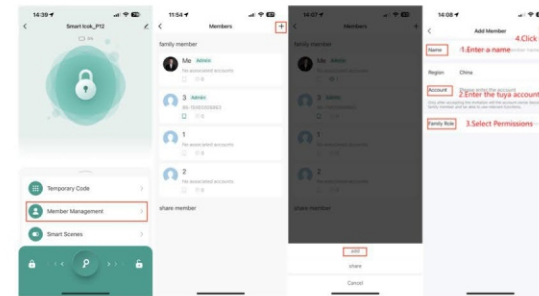

1. On the "Members Management" portal, click on the upper right corner of the "+" to select "Add Member", enter the member name and Tuya account, select the authority and click to save, then the administrator user would be added successfully; Note: (the administrator account to be added must have already registered Tuya intelligent account, otherwise the account will not be able to add)
2. After the added account opens the Tuya APP, it will receive the invitation message, and will have the management rights of the device upon consent;
3. All the key information added by this account entrance will be administrator authority by default;



## VII. Member Management - Addition of Ordinary Members

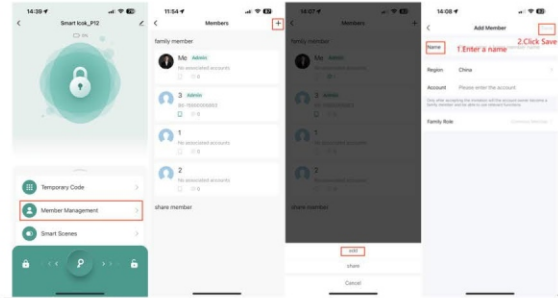

1. On the "Member Management" portal, click "+" in the upper-right corner to select "Add Member", enter the member name (no need to enter the account), and click to save, adding the ordinary member user successfully.
2. All the key information added in this account will have the authority of the ordinary users' authority by default;

## VIII. Deletion of Family Member

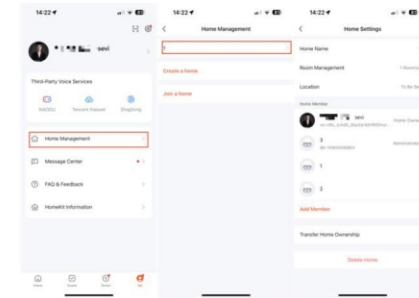

1. Click on "My" → "Family Management" at the bottom right corner of the APP, select family, you can delete the added family members or change the access authority;

## IX. Door Open Records and Equipment Alarm

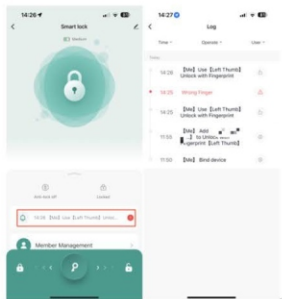

1. Click the “Alarm” icon to view the door open record, trial and error alarms and other information;

Note: When the door lock is connected to the mobile phone Bluetooth, the open door records and alarm will be displayed on the APP in real time, otherwise, the record will be cached locally in the door lock, which will be transmitted when the door lock is connected to the mobile phone Bluetooth and opens the door on the next time.

## X. Factory Data Reset

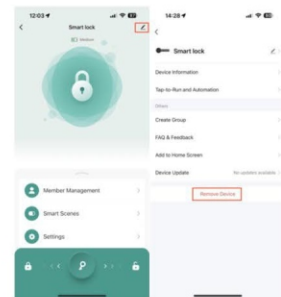

Click the icon in the upper right corner of the main page, enter the interface to find “Remove Device”, and select “Unbind and Clear Data”.

1. When the APP is connected with the door lock by Bluetooth (online status), operate the “delete equipment” setting, all the door lock’s local door opening methods will be deleted, and the door lock will be restored to the factory-fresh state, and other users can re-add the door lock through the APP.
2. When the mobile phone APP is connected to the door lock by Bluetooth (offline), operate the “delete equipment” setting. The door open records data on the door lock will still be retained and will not be affected. Other users can re-pair with the door lock through APP, in which case the original unlocking data on the door lock will be invalid after pairing.
3. Hold and press the setup button on the rear panel for 5 seconds → blue light flashes, and after red light flashes for 6 seconds, release the button. At this time, all the recorded opening methods will be deleted, and the APP will be automatically unbounded at the same time;

## XI. Technical Parameter of Product

SN	Function	Content	Description
1.	Unlocking Method	Fingerprint + Password + Card + Tuya APP + Remote Control (Optional)	The lock will lock 5 seconds after locking by fingerprint which can be changed in the settings of APP
2	Number of Secret Keys	300 Groups	The total capacity include fingerprints of 100 groups, passwords of 100 groups and cards of 100 groups
3	Low Voltage Alarm	4.8V $\pm$ 0.2V	When the voltage is lower than 4.8 V, the system prompts that low battery, please replace the batteries in a timely manner.
4	Static Current	$\leq$ 100uA	
5	Dynamic Current	$\geq$ 200mA	
6	Supply Voltage	6V $\pm$ 0.3V	Four AAA/AA dry batteries (please choose high quality alkaline 1.5V batteries), to prevent battery leakage, please replace new batteries within one year
7	Emergency Power Supply	5VDC	USB type C interface (when the battery is dead, you can use emergency power to unlock)
8	Operating Temperature	-25°C~65°C	
9	Operating Humidity	20%~90%RH	

WARNING: Please store your mechanical key outside in case of emergency or malfunction!

## Instructions for Quick Local Operations on the Lock Terminal

Wake up the screen and then enter the following instructions for quick local operation

Serial No.	Command	Contents	Description
1	1#	<b>Add administrator key</b>	The initial password is 123456# for adding password for the first time; the App will automatically associate with the "Home Owner" after adding such password.
2	2#	<b>Add ordinary user key</b>	After adding the ordinary user key, you need to manually associate the "ordinary members".
3	3#	<b>Add remote control (optional)</b>	Rear panel needs to be connected to the remote control module
4	5#	<b>Switch to normally open mode</b>	After the administrator opens the lock, the screen lights up and shows "5#" under which it can also quickly switch to the normally open mode, and after the user opens the lock, the normally open mode would be closed by default;
5	9#	<b>Turn on mobile phone Bluetooth configuration</b>	If the administrator has been recorded locally at the lock terminal, it shall be verified by the administrator in order to open the Bluetooth configuration for binding. This command is invalid after successful binding;
6	21#	<b>Set volume</b>	3 represents high; 2 represents middle, 1 represents low; and 0 represent silent
7	888#	<b>Restore factory settings</b>	Verified by administrator
8	"*#" Key	<b>Add administrator key</b>	
9	"#" Key	<b>Add ordinary user key</b>	
10	Electronic Double Lock	<b>Add remote control (optional)</b>	After pushing the indoor panel, the electronic anti-locking device can be safely unlocked, with announcing that the door has been double locked (the administrator can unlock the door, but other ordinary users can't unlock the door).

This device complies with part 15 of the FCC Rules. Operation is subject to the following two conditions: (1) This device may not cause harmful interference, and (2) this device must accept any interference received, including interference that may cause undesired operation.

Any Changes or modifications not expressly approved by the party responsible for compliance could void the user's authority to operate the equipment.

**Note:** This equipment has been tested and found to comply with the limits for a Class B digital device, pursuant to part 15 of the FCC Rules. These limits are designed to provide reasonable protection against harmful interference in a residential installation. This equipment generates uses and can radiate radio frequency energy and, if not installed and used in accordance with the instructions, may cause harmful interference to radio communications. However, there is no guarantee that interference will not occur in a particular installation. If this equipment does cause harmful interference to radio or television reception, which can be determined by turning the equipment off and on, the user is encouraged to try to correct the interference by one or more of the following measures:

- Reorient or relocate the receiving antenna.
- Increase the separation between the equipment and receiver.
- Connect the equipment into an outlet on a circuit different from that to which the receiver is connected.
- Consult the dealer or an experienced radio/TV technician for help.

FCC Radiation Exposure statement

The device has been evaluatec to meel general RF exposure requirement. The device can be used in porlable exposure condition without restriction.